

UP

Universitatea
Politehnica
Timișoara

Research Report 2015

**Research
Annual
Report**

Politehnica
University
of Timisoara

2015

Research Report 2015

Research Report, 2015

The second edition of Research Report 2015, revised and expanded.

Copyright © Editura Politehnica 2015

All rights reserved to Politehnica University of Timisoara.

No part of this booklet may be reproduced or transmitted in any form or by any means, electronic or mechanical, including photocopy, recording, or any information storage and retrieval system now known or to be invented, without permission in writing from the publisher, except by a reviewer who wishes to quote brief passages in connection with a review written for inclusion in a magazine, newspaper, or broadcast.

Editorial team

Editor:

Prof. Marius-Emil OTEȘTEANU, PhD

Co-Editor:

Roxana Mihaela SÎRBU

Layout & cover design: Eugen STAN

Editura Politehnica

Bv. Republicii, nr. 9, 300159

Timișoara, România

Phone: +40 256 403823

Fax: +40 256 403021

ISSN 1841-2769

Research
Report 2015

**Research
Annual
Report**
Politehnica
University
of Timisoara
2015

Structure of the report

Introducing the Report.....	5
Research Centers.....	9
Scientific Excellence Awards	15
Projects supported by public funds.....	33
Research Projects.....	39
Projectssupportingresearch.....	107
Projects supported by private funds.....	131
Patents.....	157
Granted Patent.....	159
UtilityModels.....	161
UtilityModelsRequests.....	165
Honorary Members.....	169
DoctorHonorisCausa.....	173
HonoraryProfessors.....	174
HabilitationThesis.....	179
PhDThesis.....	193
ScientificConferences.....	205
ScientificJournals.....	211
ISIPapers.....	217
ISIPapersinhighlight.....	221
PapersinISIJournals.....	229
PapersinSIProceedings.....	241
Books.....	255
Books in highlight	259
Books List	263

Introducing the Report

“It’s not the walls that make a school, but the spirit living inside.”

King Ferdinand I, 1923

The needs for a modern society, in the context of a competitive global market, require highly skilled human resource development. In this context, the role of universities in the innovation process has increased continuously over time because the development of new products or technologies depends increasingly on the findings of scientific research.

Established in 1920, shortly after the union of Romanian territories, in a European context marked by the redefinition of states and by the aftermath of World War I, the Polytechnic School in Timisoara – as was originally called – was the answer to one of the requirements of the Romanian society of the time, namely the formation of engineers.

The mission of the Politehnica University of Timisoara is to offer nationally competitive and internationally recognized opportunities for Learning, Research, and Innovation at the highest levels of excellence. As a knowledge resource to the public, the university builds partnerships with other educational institutions, community organizations, government agencies, and the private sector to fulfill the requirements for competences of the societal environment through superior professional training for students and graduates. In 2015, Politehnica University of Timisoara celebrate the 95 years that have brought us where we stand today.

The present Research Report of Politehnica University of Timisoara gathers the main results obtained through the research activities carried out within the university in 2015, Politehnica being renowned as a remarkable actor on the stage of scientific research, both at national and international level. Our research activity is facilitated by the existence of twenty-five research centres specialized in fields that are capital for the sustainable development of any modern society. Each of these research centres brings together various prestigious researchers, whom, by their effort and vision, provide UPT with the incentives needed to contribute to the progress of our society.

Most of the research activity carried out by our institution is financed through external sources, obtained either from national and international calls for projects, or through agreements with private companies. This represents a confirmation of the superior quality of the research, but also of the prestige and professional deontology of the researchers affiliated to our institution. Politehnica’s reputation as an institution of advanced research is emphasized also by the patents obtained by its researchers, by the medals and prizes obtained in both national and international competitions, and by the collaborations with important research centres and institutes from Romania and from abroad.

Each year, we select the most talented young researchers for our doctoral school, providing them with the opportunity to transform their knowledge and ideas into the innovations of tomorrow. Many of them take part in peer learning programs consolidating the relationship between our university and similar partner institutions. They strive for becoming doctors in science and for making the world a better place.

This report is divided into thirteen sections, each one presenting a specific component of the research activity performed within the institution.

In the first section, the research infrastructure is presented, which comprises the twenty-five research centres hosted by the university. The order in which they are presented is given by the research fields. The important number of research centres, respectively teams of researchers constituted ad-hoc, on different themes, successfully put in practice the scientific research strategy of the university, within the framework of numerous grants and contracts won by competition. The results of the research are materialized in papers, patents and products, all bringing for the University prestige, as well as important funds.

The second section of the Research Report is dedicated to the Scientific Excellence Awards, these prestigious awards celebrate those who have made a significant contribution in their field of research and continue to inspire future generations to become involve in science.

The third and fourth sections include the research projects implemented by the university. The third section includes the projects supported by public funds, both national and international, while the fourth one includes the projects supported by private funds awarded by companies. For the purposes of this report, we have chosen the most relevant projects for our research capacity. Within each section, the projects are arranged by doctoral studies fields of IOSUD - UPT.

The innovative capacity of the University Politehnica Timisoara is supported by teachers and scientific researchers through patents and utility models invented, presented in the fifth section.

Politehnica University of Timisoara recognizes scientific excellence by conferring the honorary degree of Doctor Honoris Causa and Honorary Professor to distinguished Researchers for their contribution to the development of UPT and continuous support, as is shown in sections six and seven.

Sections eight and nine include habilitation theses and PhD theses held in 2015 in our University.

Section ten presents an overview of the most relevant scientific conferences that brought together professionals from Romania and from abroad, hosting and encouraging the dialogue, exchange of ideas and the opportunity for new collaborations.

The eleventh section gathers the scientific journals that have been edited by our institution. This category includes journals specialized in various fields like computer science, chemistry and environmental engineering, electronics and communications, economics and social sciences, electrical engineering, hydrotechnics, physical education and sport, modern languages etc.

The dissemination of research results and findings is an integral part of the research process and the career in academia. In section twelve are presented the most relevant scientific researches that have been published in 2015, comprising the results obtained by our researchers, papers that obtained recognition from some of the most prestigious journals, both from Romania, and from abroad.

And finally the thirteenth section comprises a collection of books written by our researchers, most of them published under Politehnica Publishing House, but not limited to it.

Through research we generate ideas, through ideas we generate innovation and through innovation we contribute to the improvement of the quality of life; this is why research is our priority.

Research Centres



Research Institute for Renewable Energy

Director: prof. Viorel UNGUREANU

Contact: viorel.ungureanu@upt.ro, www.icer.ro

Research projects unwder implementation can be found at pages: 83-84; 94; 147-148;



Research Centre for Computers and Information Technology

Director: prof. Vladimir-Ioan CREȚU

Contact: vladimir.cretu@upt.ro, <http://www.cs.upt.ro/~vcretu>

Research projects unwder implementation can be found at pages: 39-40; 109-110; 111-112; 112-113;



Research Centre for Automatic Systems Engineering

Director: prof. Radu-Emil PRECUP

Contact: radu.precup@upt.ro, <http://www.aut.upt.ro/centru-cercetare>

Research projects unwder implementation can be found at pages: 43-44; 45-46; 47-48;



Research Centre for Power Systems Analysis and Optimization

Director: prof. Ștefan KILYENI

Contact: stefan.kilyeni@upt.ro, <http://www.et.upt.ro/index.php?sublink=1694&link=10&pag=2&lang=ro>

Research projects unwder implementation can be found at pages: 49; 137; 138; 139; 140;



Research Centre for Smart Energy Conversion and Storage

Director: prof. Nicolae MUNTEAN

Contact: nicolae.muntean@upt.ro, <http://www.et.upt.ro/index.php?link=10&sublink=1695&pag=1&lang=en>



Research Centre for Intelligent Electronic Systems

Director: prof. Marius OTEȘTEANU

Contact: marius.otesteanu@upt.ro, <http://www.ccesi.etc.upt.ro/index.php/ro>



Research Centre for Intelligent Signal Processing

Director: prof. Alexandru ISAR

Contact: alexandru.isar@upt.ro, <http://www.tc.etc.upt.ro/isprc>

Research projects unwder implementation can be found at pages: 51-52; 53-54;



Research Centre for Multimedia

Director: prof. Radu VASIU

Contact: radu.vasiu@upt.ro, <http://www.cm.upt.ro>



Research Centre for Environmental Science and Engineering

Director: prof. Rodica PODE

Contact: rodica.pode@upt.ro, http://www.chim.upt.ro/Facultatea-de-Chimie-Industriala-si-Ingineria-Mediului-Centru_GF.html

Research projects unwder implementation can be found at pages: 99-100; 152; 153; 154;



Research Centre for Inorganic Materials and Alternative Energies

Director: prof. Ioan LAZĂU

Contact: ioan.lazau@upt.ro, http://www.chim.upt.ro/Facultatea-de-Chimie-Industrială-si-Ingineria-Mediului-Centru_Zx.html



Research Centre for Organic, Macromolecular and Natural Compounds' Chemistry and Engineering

Director: prof. Corneliu DAVIDESCU

Contact: corneliu.davidescu@upt.ro, http://www.chim.upt.ro/Facultatea-de-Chimie-Industrială-si-Ingineria-Mediului-Centru_VT.html



Research Centre for Mechanics of Materials and Structural Safety

Director: prof. Dan DUBINĂ

Contact: dan.dubina@upt.ro, <http://www.ct.upt.ro/centre/cemsig/>

Research projects unwder implementation can be found at pages: 55-56; 57-58; 59-60; 61-62; 63-64; 65-66; 67-68;



Research Centre for Hidrotechnics

Director: prof. Teodor Eugen MAN

Contact: eugen.man@upt.ro, <http://www.ct.upt.ro/centre/cchpm.htm>



Research Centre for Building Services

Director: prof. Ioan BORZA

Contact: ioan.borza@upt.ro, <http://www.ct.upt.ro/centre/ccic/>



Research Centre for Retrofitting of Constructions

Director: prof. Valeriu STOIAN

Contact: valeriu.stoian@upt.ro, <http://www.ct.upt.ro/centre/reco.htm>

Research projects unwder implementation can be found at pages: 69-70;



Research Centre for Construction and Transportation Substructures

Director: prof. Marin MARIN

Contact: marin.marin@upt.ro, <http://www.ct.upt.ro/centre/ict/index.htm>

Research projects unwder implementation can be found at pages: 113-114; 141; 142; 143; 144;



Research Centre for Mechatronics and Robotics

Director: prof. Inocențiu MANIU

Contact: inocentiu.maniu@upt.ro

Research projects unwder implementation can be found at pages: 85-86;



Research Centre for Medical Engineering

Director: -
Contact: <http://cmpicsu.upt.ro>



Research Centre for Integrated Engineering

Director: prof. George DRAGHICI
Contact: george.draghici@upt.ro, http://www.eng.upt.ro/imf/ccii/index_en.html
Research projects unwder implementation can be found at pages: 127-128;



Research Centre for Processing and Characterization of Advanced Materials

Director: conf. Bogdan RADU
Contact: bogdan.radu@upt.ro, <http://eng.upt.ro/ccpcma>
Research projects unwder implementation can be found at pages: 87-88;



Research Centre for Complex Fluid Systems Engineering

Director: prof. Romeo SUSAN-RESIGA
Contact: romeo.resiga@upt.ro, <http://mh.mec.upt.ro/cnisfc>
Research projects unwder implementation can be found at pages: 75; 76; 77-78; 79-80;



Research Centre for Thermal Machines and Equipments, Transportation and Environmental Pollution Control

Director: prof. Ioana IONEL
Contact: ioana.ionel@upt.ro, <http://mettcp.mec.upt.ro/>
Research projects unwder implementation can be found at pages: 119-120; 121-122; 123-124; 125-126; 145-146; 147-148; 149;



Research Centre for Engineering and Management

Director: prof. Monica IZVERCIANU
Contact: monica.izvercianu@upt.ro, <http://www.mpt.upt.ro/pag/centru%20cercetare.html>
Research projects unwder implementation can be found at pages: 93; 150; 151;



Research Centre for Urban Planning

Director: prof. Radu RADOSLAV
Contact: radu.radoslav@upt.ro, <http://ccddt.blogspot.ro>



Research Centre for Advanced Study Methods for Physical Phenomena

Director: prof. Dumitru TOADER
Contact: dumitru.toader@upt.ro, <http://www.et.upt.ro/etf/index.php?sublink=24&link=2&lang=ro>

Scientific Excellence Awards

NEW ACADEMICIAN IN UPT - Prof. Dan DUBINĂ, PhD

- The Romanian Academy have 181 acting members (Academicians and Corresponding Members), a number established by law; all members of the Academy are elected for life.
- Eligibility criteria include Romanian citizenship and outstanding performance in a scientific, artistic or literary domain. Candidates for associate membership can be up to 65 years old and can become full members any time after that. The Academy also has 135 honorary members who are both Romanian and foreign citizens of great intellectual value; their number is established by the General Assembly. Age is not a criterion for eligibility as an honorary member.
- Membership in the Academy confers certain rights, of which foremost are, naturally, the moral ones. Members of the Academy enjoy recognition for their excellence, contribute to the direction of the Academy's activity through their opinions and votes, participate in the activity of the Academy's sections and scientific institutes in their respective domain, and the Academy's full members bear the much coveted title of "Academician".
- Over the yers, Politehnica University of Timisoara gathered 16 Academicians and 12 Corresponding Members.

Academician Dan DUBINĂ

Academician Dubină is professor and head of the Department of Steel Structures and Structural Mechanics at the Politehnica University of Timisoara, Romania.

He has published more than 400 scientific papers and 25 books in the field of cold-formed steel structures, steel structures in seismic areas, structural connections, and structural analysis. He is a member of the ECCS Technical Committees TC 7 (Cold Formed Thin Walled Sheet Steel in Building), TC 8 (Stability), TC 10 (Connections), and TC 13 (Seismic Design).

He has been awarded with the ECCS European Steel Design Award twice.



Key Qualifications

- Head of Department of Steel Structures and Structural Mechanics, at Faculty of Civil Engineering of PU Timisoara.
- Member in the Academic Board (University Senate) of Politehnica University of Timisoara
- Director of Research Centre for Mechanics of Materials and Structural Reliability (CEMSIG)
- Member COSCO (Committee for Coal and Steel- RFCS) for Romania
- Member of the Executive Board of ECCS, former President of ECCS (2005/2006)
- Member of Civil Engineering Commission of National Committee for Academic Titles and Diplomas (CNATDCU), Romanian Ministry of Education
- President of APCMR – Romanian Association of Constructional Steelworks Steel and Composite
- Vice-President of Romanian Association of Structural Engineers (AICPS)
- Vice President of National Committee for Seismic Engineering and Technical Committee of Structures, CS 5, Ministry of Regional

Development and Administration of Patrimony (MDRAP)

- Member of Technical Committee CT 343 (RO) for Structural Reliability an Structural Eurocodes of Romanian Association for Standardization (ASRO, coordinator for Eurocodes 3 and 9. Member of WGs 1.1, 1.3, 1.8, 1.10/EN 1993/CEN
- Code Drafter (Coordinator and/or author for Standards and Technical Regulations in the Field of Steel Structures, Seismic Engineering, Fire design.
- Project Coordinator of several R&D projects involving partners from several European countries.

Research focus

- Steel Structures in Seismic Zones (global performance/ connections/ rehabilitation)
- Cold formed steel structures/ Stability/ Advanced design/
- Robustness of structures under extreme actions

IEEE NIKOLA TESLA AWARD - Prof. Ion Gheorghe BOLDEA, PhD Corresponding Member of the Romanian Academy

- The IEEE Nikola Tesla Award was established in 1975 through an agreement between the IEEE Power Engineering Society and the IEEE Board of Directors.
- The Award is named in honor of Nikola Tesla, an electrical engineer, a distinguished Yugoslav-American inventor, and a pioneer in many fields, who is most renowned for the development of the coil that bears his name and the a-c induction motor.
- The IEEE Nikola Tesla Award is granted for outstanding contributions to the generation and utilization of electric power.

BIOGRAPHY

Prof. Ion Gheorghe BOLDEA, PhD in Electrical Engineering in 1973 has worked exclusively for University Politehnica Timisoara Romania, but spent more than 5 years in total as visiting scholar in USA and UK, while delivering intensive courses, keynote addresses IA-IEEE DLs (since 2008) in USA, S. America, EU and Asia, with technical consulting over decades for companies like GM, Bosch, Vestas, Hilti, Hyosung, EMBRACO, Scumberger etc.

His technical expertise is related to electric energy conversion and control by power electronics for better industrial productivity, energy savings and air pollution reduction. Besides the academic involvement he was a founding co-owner for 20 years of an industrial digital electric automation (IDEA) private enterprise that has now more than 60 engineers.

His technical expertise is related to electric energy conversion and control by power electronics for better industrial productivity, energy savings and air pollution reduction.

Besides the academic involvement he was a founding co-owner for 20 years of an industrial digital electric automation (IDEA) private enterprise that has now more than 60 engineers.

He worked and published on linear and rotary electric machinery design and control (18 books and more than 150 IEEEExplore papers, 30 patents etc.).

He received 4 IEEE paper awards, and is a member of Romanian Academy of Technical Sciences and of Romanian Academy.

Prof. Boldea initiated cooperation with many universities such as those of Kentucky, Oregon and Texas at Dallas in USA, Cassino, Bologna, Torino, Trieste in Italy, Hanyang in Korea, Aalborg University in Denmark where he holds a Doctor Honoris Causa.

Specific contributions

- The introduction of the optimum goodness factor for the design of linear induction motors of high speed(1976);
- First integrated-propulsion-levitation passive guideway MAGLEV –Magnibus(4 ton prototype on an 150m test track) with linear homopolar synchronous motors and over all power factor and energy conversion above 80% (1986);



- Generalization in 1988 of the to be DTC (in 1995), proposed initially (1985) only for IMs, under the name of TVC, for both voltage and current source inverter, for all ac motor drives;
- The design and testing the largest power factor(0.91, at 1500W and 3.6krpm) reluctance synchronous motor (2 poles, ALA rotor) in 1992;
- 3rpm full torque sensorless control for an IM DTC drive without signal injection, using sliding mode observers and regulators(2000);
- The introduction of the first matrix converter in the terminal box of an induction motor(2000);
- The introduction of BEGA(an IPMSM with additional dc excitation in an axis at 90 degrees with respect to magnets axis) to produce very large CPSR at unity power factor and pure resistive generator voltage drop by zero Id and zero Psiq active control (2006);
- Introducing the concept of “active flux” as a unifying concept to simplify sensorless(advanced) control of all ac motor drives(2008);
- Optimal design deterministic and evolutionary methodologies for IMs and SMs with embedded FEM (2010);
- Contribution to the revival and development of No-PM Brushless DC multiphase reluctance machines with dual flat top;
- current control for high performance over wide CPSR with simplified control and applications for electric transport and wind/hydro generators (2012);

New Corresponding Member of the Romanian Academy Prof. Vasile MARINCA, PhD

- Romanian Academy is “the highest scientific authority in the country, bringing together the worthiest personalities in science, technology, education, culture and art in Romania, as representing the creative spirituality of the nation.”

BIOGRAPHY

Vasile Marinca is professor at the University Politehnica Timisoara, Department of Mechanics and Strength of Materials since 1978. He received his PhD degree in 1991 with the thesis “Inverse Problems in Analytical Mechanics”.

His main field of interest include nonlinear dynamical systems with application in various engineering branches, approximate analytical methods, nonlinear vibration, theoretical and applied mechanics.

Specific contributions

The most important achievements obtained in the past years are included in two major monographs published by the famous Springer in 2011 and 2015:

- The first monograph entitled „*Nonlinear Dynamical Systems in Engineering. Some Approximate Approaches*” has been cited so far 55 times in the literature and can be found (according to the international catalog WorldCat) in 288 university libraries from all over the world, including the famous MIT and Stanford University
- The second monograph, published in 2015 with the title „*The Optimal Homotopy Asymptotic Method. Engineering Applications*” can already be found in the libraries of the most important top universities of the world (136 university libraries from all over the world, according to www.worldcat.org).
- Prof. marinca authored or co-authored more than 175 papers, among them being 18 papers published in journals ranked in the “red zone” (defined by CNCS) of the journals quoted by ISI-Thomson in JCR (first quartile of the ranking). His papers received so far more than 800 citations on Web of Science and more than 1350 citations on Google Scholar. It to remark that two of his papers (published in International Commun. in Heat and Mass Transfer in 2008 si Applied Math. Letters in 2009) are marked on ISI - Web of Science as „Highly Cited Papers”, which means they belong to 1% most intensely cited papers of the domain „Engineering” in the case of the first paper, respectively „Mathematics” in the case of the second paper.
- Professor Marinca acted as editor within the editorial Board of „Journal of Applied Mathematics” and „The Open Applied Mathematics Journal”, and also was a guest editor for the Special



Issue „Advances in Nonlinear Vibration” organised in 2012 by the Journal of Applied Mathematics. He is a reviewer for a significant number of reputed international journals and also reviewer for Zentralblatt-Berlin. His H-index is 14 on Web of Science and 18 on Google Scholar.

- Professor Marinca is the principal investigator for a number of 12 research grants financed by CNCSU, ANSTI, CNCSIS and Romanian Academy and also for 14 contracts with the industry. He was included by the American Biographical Institute in The International Directory of Distinguished Leadership, he received a research grant financed by the Open Society and he served as assessor for many research proposals received by CNCSIS, ANCS, UEFISCDI and European Commission (Bruxelles, code EX2002B004947-005)
- He proposed in the literature 7 new approximate analytical methods for solving nonlinear dynamical systems, among them the Optimal Homotopy Asymptotic Method (OHAM) being the most popular, since it was adopted by many researchers in their papers and PhD thesis. There are already published in the open literature several hundred scientific papers whose authors (most of them from abroad) used this new method.
- As recognition of his scientific activity and achievements, on 26 November 2015 prof. Vasile Marinca was elected as Corresponding Member of the Romanian Academy.

BANAT EXCELLENCE GALA - 2nd Edition - "Traian Lalescu" Award for Mathematics and Natural Sciences, Lecturer Robert IANOȘ, PhD

Banat Excellence Gala - 2nd Edition

- Organized by the Romanian Academy - Timisoara Branch, State Universities of Timisoara and National Grand Lodge of Romania
- On the occasion, they were awarded personalities of the academic environment of Banat from different fields of science: natural science, social science, engineering, humanities, biological science, agronomical and civic involvement. Also, awards were granted to organizations from Banat with excellent results in education and sport.

Politehnica University of Timisoara has received two awards within the Gala of Excellence:

- "Traian Lalescu" Award for "Mathematics and Natural Sciences" - Lecturer Robert IANOȘ, PhD
- "Traian Vuia" Award for "Engineering Sciences" - Prof. Radu-Emil Precup, PhD

BIOGRAPHY

- Robert IANOȘ is a PhD Lecturer at Politehnica University of Timișoara, Faculty of Industrial Chemistry and Environmental Engineering, Department of Applied Chemistry and Inorganic Compounds and Environmental Engineering. He received his PhD in 2008, after defending the PhD thesis: "Solution combustion synthesis of oxides, metal oxides and oxide solid solutions".
- Robert IANOȘ activates in the field of metal oxide (nano) powder preparation via solution combustion synthesis.
- He published overall 43 peer-reviewed papers in ISI ranked journals, 5 books, 1 Romanian OSIM patent and 1 Romanian OSIM patent application. Among the 43 ISI articles, Robert IANOȘ is the main author of 28 ISI articles, which reflects the high degree of autonomy.
- According to Scopus (09.02.2016), Robert IANOȘ has a Hirsch index of 10 (self-citations and the citations of all co-authors excluded) and his papers received a number of 316 citations (self-citations and the citations of all co-authors excluded). The large number of received citations suggests that the ISI papers published by Robert IANOȘ have a significant impact in his research field.
- The quality of the ISI published papers is highlighted by the high impact factor of the journals in which Robert IANOȘ has published. Almost 80 % of the total number of ISI papers were published in ISI journals having an impact factor higher than 2.
- In 2010 Robert IANOȘ was awarded the "In Hoc Signo Vinces" prize (distinction Magna cum Laude) for outstanding achievements in scientific research, by the National Council for Scientific Research in Higher Education.
- In the same year Robert IANOȘ was awarded the "Eminent Researcher" prize for outstanding results in teaching and research activity, by the Academic Horizons Association.



- Based on his expertise, Robert IANOȘ was invited to join the reviewer team of 24 prestigious ISI-ranked journals (E.g. Advanced Functional Materials I.F. – 11.805, Small I.F. – 8.368, Current Opinion in Solid State & Materials Science I.F. – 6.235), having reviewed more than 35 manuscripts.
- The ability to coordinate research activities is reflected by the presence of Robert IANOȘ as a member of the mentoring committees of 4 PhD students, which have defended their PhD theses.
- Robert IANOȘ confirmed his ability to conduct high quality scientific research, as he is/was actively involved as a project leader (3 grants) and long-term expert or member of the research team in other 4 research grants.
- As recognition of his scientific activity and achievements, on December 2015 Robert IANOȘ received the "Traian Lalescu" award for Mathematics and Natural Sciences, within the Second Edition of Banat Excellence Gala.

BANAT EXCELLENCE GALA - "Traian Vuia" Award for Engineering Science, and UPT - "Excellence in Science for 2015" Award, Prof. Radu-Emil PRECUP, PhD

- Politehnica University of Timisoara is the first in the world in the field Controllers, Control and Tuning. Professor Radu-Emil Precup from Politehnica University of Timisoara was named the best in the world in the field of automation, science dealing with the study and development of structures and equipment capable of providing leadership systems without human intervention.
- On 17 December 2015 the Politehnica University of Timisoara granted Professor Radu-Emil Precup the Award "Excellence in Research for 2015" for advanced research activity which reconfirmed the high performance of our higher education institution.
- At the 2nd Edition of Banat Excellence Gala Professor Radu-Emil Precup has received "Traian Vuia" Award for "Engineering Sciences".

BIOGRAPHY

- Radu-Emil PRECUP was born in Lugoj, Romania, in 1963. He received the Dipl.Ing. (Hons.) degree in automation and computers from the "Traian Vuia" Polytechnic Institute of Timisoara, Timisoara, Romania, in 1987, the Diploma in mathematics from the West University of Timisoara, Timisoara, in 1993, and the Ph.D. degree in automatic systems from the "Politehnica" University of Timisoara, Timisoara, in 1996.
- Radu Emil PRECUP became a Professor in the Department of Automation and Applied Informatics, in 2000, and he is currently a Doctoral Supervisor of automation and systems engineering.
- He is also an Honorary Professor and a Member of the Doctoral School of Applied Informatics with the Óbuda University (previously named Budapest Tech Polytechnical Institution), Budapest, Hungary. He is currently the Director of the Automatic Systems Engineering Research Centre with the Politehnica University of Timisoara, Romania.
- From 1999 to 2009, he held research and teaching positions with the Université de Savoie, Chambéry and Annecy, France, Budapest Tech Polytechnical Institution, Budapest, Hungary, Vienna University of Technology, Vienna, Austria, and Budapest University of Technology and Economics, Budapest, Hungary. He has been an Editor-in-Chief of the International Journal of Artificial Intelligence since 2008 and he is also on the editorial board of several other prestigious journals.
- He is the author or coauthor of more than 300 papers published in various scientific journals, refereed conference proceedings, and contributions to books. His research interests include mainly development and analysis of new control structures and algorithms (conventional control, fuzzy control, data-based control, sliding mode control, neuro-fuzzy control, etc.), theory and applications of soft computing, computer-aided design of control systems, modelling, optimization (including nature-inspired algorithms), and applications to mechatronic systems (including automotive systems and mobile robots), embedded systems, control of power plants, servo systems, electrical driving systems.



HONOURS:

- Recipient of the Award "Excellence in Research for 2015" from UPT;
- Recipient of the "Traian Vuia" Award for "Engineering Sciences" within the 2nd Edition of Banat Excellence
- Recipient of the "Grigore Moisil" Prize from the Romanian Academy for contributions on fuzzy control (2005)
- Honorary Professor of Óbuda University, Hungary (2007).
- Honorary member of Hungarian Fuzzy Association (HFA, MFT, Budapest, since 2005)
- Senior Member, IEEE (since 2007).
- **Best Paper Awards:** Certificate of Appreciation for the Best Paper at 39th Annual Conference of the IEEE Industrial Electronics Society IECON 2013 (Vienna, Austria); Best Paper Award at 16th Online World Conference on Soft Computing in Industrial Applications WSC16 (Loughborough University, UK, 2011); two Best Paper Awards in the Intelligent Control Area at the 2008 Conference on Human System Interaction HSI 2008, Krakow (Poland).
- Recipient of the Excellency Diploma of the Faculty of Automation and Computers for special merits in the research expressed by publications (Timisoara, 2006), and diploma for special performance obtained in the activity carried out in the Faculty of Automation and Computers (Timisoara, 2005).
- Recipient of the Excellency Diploma of the International Conference on Automation, Quality & Testing, Robotics AQTR 2004 (THETA 14, Cluj-Napoca, Romania).
- Recipient of the Certificate of Achievement from the IEEE Romania Section for notable services and contributions towards the advancement of the engineering professions (2011).

“Prof dr. Mircea Nicolae SABĂU” ARA Awards for Excellence in Physics/Chemistry - Prof. Ioana IONEL, PhD

- The American Romanian Academy of Arts and Sciences (ARA) is an internationally recognised academic research and educational institution that conducts and supports multidisciplinary studies in exact sciences, mathematics, natural sciences, and also supports the arts, linguistics, literature, political studies and sociology. As an institution its main goal is to foster cultural exchanges between the American and Romanian cultures.
- ARA was founded in California in 1975 by a group of American-Romanians, and in 2014 has 119 elected members, 81 corresponding members, and 59 honorary members.

Ioana Ionel was born on June 24, 1953 in Cimpulung, Romania, and she is professor at the Politehnica University of Timisoara, department of and guest professor at the Technical University from Munich, Germany.

Her scientific development was mainly influenced by two events: PhD degree awarded 1987 and the Alexander von Humboldt fellowship, starting 1991.

She has as main area of expertise for teaching and research topics concerning Thermodynamics, Clean Combustion, Environmental protection and Renewable Energy applications.

In 2001 she habilitated at Technology University Munich based on a thesis and research concerning the quality of air, methods for investigations and clean technologies' applications for power plants.

She is leader and director of a specialized research centre consisting of different ISO 17025 attested labs, mainly the air quality (www.mediu.ro) monitoring and renewable energy resources are to be mentioned (<http://energieregen.mec.upt.ro>).

She is author of several books in Romanian, German and English, notable are the recent series of literature authored or coordinated concerning renewable energy resources such as biomass, biofuels, biogas, bioenergy in general.

Her activity consists both in lecturing at home and abroad, as invited professor, also for summer schools.

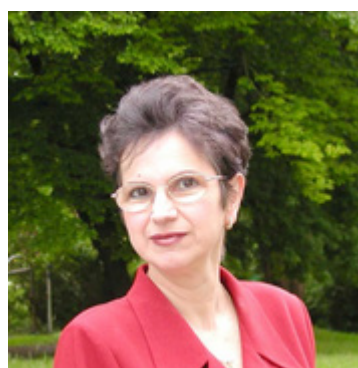

Numerous research project, on national, European, and international level have been coordinated, as well as expertise grants are offered to the private industrial sector. The coordination of PhD students is also notable.

Prof. Ioana Ionel is fellow at: Humboldt Foundation, member: Association Termotehnicienilor din Romania, Verrein der Deutschen Ingenioere, Balkan Environmental Association, American Romanian Academy.

Corneliu BIRTOK-BĂNEASĂ - the most awarded PhD Student from UPT at Salons of Inventions worldwide

- Romania is known for having given the world some of its greatest minds. Mathematicians, scientists and inventors have successfully represented Romania in international competition over the years. Politehnica University of Timișoara has one of this brilliant mind - Corneliu Birtok-Băneasă, PhD Student.

BIOGRAPHY

Corneliu BIRTOK-BĂNEASĂ is PhD student at the Politehnica University of Timișoara, Faculty of Engineering Hunedoara, Department of Engineering and Management, since 2015. He received his Bachelor degree in 2010 in the field of Road Vehicle, at Faculty of Engineering Hunedoara. In 2012 he received the Master degree in Automotive Engineering / Construction and operation of road vehicles, at the Politehnica University of Timișoara, Faculty of Mechanics.

- He was technical manager at the Company – S.C. LINIARIS GALA S.R.L.–Deva between 2011 and 2013. Since 2008 until now he is Chief Executive Officer of Company-Association Corneliugroup.

Specific contributions

His main field of interest include optimisation of air intake for internal combustion engine. The most important achievements obtained in the past years are included in one monography entitled: The internal combustion engine air intake – Superabsorbing filters – Dynamic air transfer systems, published by the Politehnica Publishing in 2011.

- He authored or co-authored more than 20 papers, published in journals and national and international conferences.

His is also co-author at the chapter 8 entitle: THE STUDY OF INFLOW IMPROVEMENT IN SPARK ENGINES BY USING NEW CONCEPTS OF AIR FILTERS from the book: Internal Combustion Engines - Edited by Kazimierz Lejda and Pawet Wos, InTech, Janeza Trdine 9, 51000 Rijeka, Croatia.

He patented The Super absorbent filter (Patent No. 126019) and The Inversed super absorbent filter (Patent No. 125034). Also he obtained the Utility model certificate for Integrated deflector of thermal radiations generated by the cooling radiator of internal combustion engines No. RO 2010 00026 and the Utility model certificate for Dynamic Device for Air transfer No. RO 2009 00028.



- The personal and original ideas, innovations and inventions belonging to Eng. Birtok-Băneasă was awarded at many national and international events.

The awards received by Corneliu BIRTOK-BĂNEASĂ:

- 26 Gold Medals:** INVENTIKA 2008; BRUSSELS 2008; INVENTIKA 2009; GENEVA 2010; INVENTICA 2010; MOSCOVA 2010; ZAGREB 2010; KUWAIT 2010; INVENTICA 2011; PROINVENT 2012; GENEVA 2012; BRUSSELS 2012; GENEVA 2013; BRUSSELS 2013; GENEVA 2014; PRO INVENT 2015; GENEVA 2015; TRAIAN VUIA 2015; INVENT _ INVEST IASI 2015; BRUSSELS 2015
- 6 Silver Medals:** GENEVA 2009; MOSCOVA 2009; BRUSSELS 2009; TRAIAN VUIA 2015; ZAGREB 2015; INVENT _ INVEST IASI 2015
- 2 Bronze medals:** ZAGREB 2009; GENEVA 2011
- 22 Special Awards.**

BEST PAPER AWARDS at 3th Asian Conference on Mechanism and Machine Science, Tianjin, China

- Aiming to enhance cross communication among researchers, industry professionals and students from Asian countries from the broad ranges of disciplines referring to mechanism and machine science.
- In addition to the regular tracks of technical presentations, the technical program will also feature several invited sessions. Topics of interests include, but are not limited to: Theoretical kinematics, Computational kinematics, Machine elements, Actuators, Gearing and transmissions, Linkage and cam, Mechanism design, Dynamics of machinery, Tribology, Vehicle mechanism, dynamics and design, Reliability, Experimental method in mechanism, Robotics and mechatronics, Biomechanics, Micro/nano mechanism and machine, Medical/welfare devices, Nature and machines, Design methodology, History of mechanism and machine science, Education in mechanism and machine science.
- The award committee will select the best papers in several fields of technical sessions and also recommend them for publication in one volume of the Mechanism and Machine Theory, the official journal of IFToMM.

The paper **Design and Control Solution for Haptic Elbow Exoskeleton Module Used in Space Telerobotics** received the “Best Paper Award” in the framework of the Asian Conference on Mechanism and Machine Science. The conference held in Tianjin, China, between July 9 to 10, 2014.

In this work the authors presented results of a research project carried out under EXORAS, financed by the Romanian Space Agency (ROSA), through contract no. 13 / 19.11.2012 -The STAR 2012.

The authors are:

Erwin Christian LOVASZ, Associated Professor at Politehnica University of Timisoara, Department of Mechatronics.
Fields of research are: Mechanism Design, Robotics, Biomedical Engineering etc.

Dan Teodor MĂRGINEANU, PhD Lecturer at Politehnica University of Timisoara, Department of Mechatronics.

Valentin CIUPE, PhD Lecturer at Politehnica University of Timisoara, Department of Mechatronics with skills and expertise in Robotics, Mechatronics, Machines, Automation, PLC, Pneumatic, Actuators, Electrical Engineering, Control Systems Engineering etc.

Inocențiu MANIU, Professor at Politehnica University of Timisoara, Department of Mechatronics with skills and expertise in Robotics, Mechanical Engineering, Electronic Engineering, Materials Engineering, Mechanism theory etc.



Corina Mihaela GRUESCU, Associated Professor at Politehnica University of Timisoara, Department of Mechatronics.

Fields of research are: Design Engineering, CAD, Optical Design, Optical Engineering, Applied Optics, Mechanical Design, Mechanical Engineering, Quantitative Image Analysis.

Sergiu Dan STAN, PhD Lecturer Technical University of Cluj-Napoca, Department of Mechatronics and Machine Dynamics with skills and expertise in: Evolutionary Algorithms, Optimization, Simulation, Algorithms, Parallel Robots, Mechatronics, Kinematics, Arduino, MATLAB Simulation, Genetic Algorithm, System Modeling.

Eugen Sever ZĂBĂVĂ, Assistant professor at Politehnica University of Timisoara, Department of Mechatronics, with expertise and skills in: Reaction Kinetics, Kinetics, Heterogeneous Catalysis, Mechanisms Kinetic Modeling, Catalyst Characterization, Catalyst Synthesis, Adsorption, CAD-Modeling, CAD, AutoCAD Mechanical, Mechatronics.

SCIENTIFIC EXCELLENCE AWARDS - BEST PRESENTATION AWARD at International Multidisciplinary Scientific Conferences on Social Sciences and Arts SGEM 2015

- SGEM Multidisciplinary Scientific Conferences were established in 2001 year with the main idea to focus the World's Scientific Elite in the most recent and innovative areas of Science.
- SGEM Conferences are well known and recognized as one of the most prestigious and with big impact factor events in the International Scientific World. SGEM Conferences till now covers all areas of the GeoSciences, with a total of 27 scientific fields. All accepted articles are published in Conference Proceedings and yearly is submitted for evaluating and indexing by ISI Web of Knowledge, Web of Science, Thomson Reuters, ELSEVIER products, SCOPUS, CrossRef, EBSCO, ProQuest, Google Scholar, Mendeley, CiteUlike, CrossRef Cited by Linking, British Library.
- Every year, during an Official Award Ceremony, all speakers (Lecturer, PhD Student, Workshops or Invited Session Speakers) receive a Certificate of Attendance given personally by one of the Scientific Chairmen of the conference.

During all these 7 days of the Conference, the audience is encouraged to give its vote to the best presentations by filling a respective nomination form. At the same time, session chairmen have the hard task to evaluate each presentation – they fill in another evaluation form and forward it to the Scientific Chairmen. As a final result, authors of the highly evaluated and most nominated presentations are awarded with a AWARD CERTIFICATE and a SPECIAL CRYSTAL PLAQUE.

Mariana Cernicova Bucă, due to the presentations made to the papers: **Universities and their identity in the 21st century** and **Strategies for promoting sport clubs in the web 2.0 era. A Romanian view** at International Multidisciplinary Scientific Conferences on Social Sciences and Arts SGEM 2015, received **"Best Presentation Award"** The conference held in Albena, Bulgaria, between August 24 to September 02, 2015.

Mariana CERNICOVA - BUCĂ is Associate Profesor at Politehnica University of Timisoara, Department of Communication and Foreign Languages with skills and expertise in Mass-media, Communication, Communication and public relations, Journalism, Professional Ethics, Lobby and advocacy etc.



EXECUTIVE UNIT FOR FINANCING HIGHER EDUCATION, RESEARCH, DEVELOPMENT AND INNOVATION - UEFISCDI AWARDS

Through these awards UEFISCDI aims to increase quality, impact and international visibility of Romanian research by recognizing and rewarding significant results published in prestigious journals from international senior scientific stream.

Within this competition can participate the researchers affiliated to institutions in Romania, authors of scientific articles published in journals indexed by Thomson Reuters Science Citation Index Expanded ("Science"), Social Sciences Citation Index ("Social Sciences") or Arts & Humanities Citation Index ("Arts & Humanities").

More information at <http://uefiscdi.gov.ro/Public/cat/471/Premierea-rezultatelor-cercetarii.html>

1. Baci, A., Ardelean, M., Pop, A., Pode, R., Manea, F. Simultaneous Voltammetric/Amperometric Determination of Sulfide and Nitrite in Water at BDD Electrode, *SENSORS*, Volume: 15, Issue: 6, Pages: 14526-14538, ISSN: 14248220, 2015;
2. Ban, O.I., Ancusa, V., Bogdan, V., Tara, I.G., Empirical Social Research to Identify Clusters of Characteristics that Underlie the Online Evaluation of Accommodation Services, *REVISTA DE CERCETARE SI INTERVENTIE SOCIALA*, Volume: 50, Pages: 293-308, ISSN: 15833410, eISSN: 15845397, 2015;
3. Belega, D., Fontanelli, D., Petri, D. Dynamic Phasor and Frequency Measurements by an Improved Taylor Weighted Least Squares Algorithm, *IEEE TRANSACTIONS ON INSTRUMENTATION AND MEASUREMENT*, Volume: 64, Issue: 8, Pages: 2165-2178, ISSN: 00189456, eISSN: 15579662, 2015;
4. Belega, D., Fontanelli, D., Petri, D. Low-Complexity Least-Squares Dynamic Synchrophasor Estimation Based on the Discrete Fourier Transform, *IEEE TRANSACTIONS ON INSTRUMENTATION AND MEASUREMENT*, Volume: 64, Issue: 12, Pages: 3284-3296, 2015;
5. Belega, D., Petri, D. Frequency estimation by two or three point interpolated Fourier algorithms based on cosine windows, *SIGNAL PROCESSING*, Volume: 117, Pages: 115-125, ISSN: 01651684, ISSN: 18792677, 2015;
6. Berer, M., Major, Z., Pinter, G., Constantinescu, DM., Marsavina, L. Investigation of the dynamic mechanical behavior of polyetheretherketone (PEEK) in the high stress tensile regime, *MECHANICS OF TIME-DEPENDENT MATERIALS*, Volume: 18 Issue: 4, Pages: 663-684, 2014;
7. Bizar, T., Lazureanu, C. On a new chaotic system, *MATHEMATICAL METHODS IN THE APPLIED SCIENCES*, Volume: 38, Issue: 8, Pages: 1631-1641, ISSN: 01704214, eISSN: 10991476, 2015;
8. Bistriari, D.A, Navon, I.M. An improved algorithm for the shallow water equations model reduction: Dynamic Mode Decomposition vs POD, *INTERNATIONAL JOURNAL FOR NUMERICAL METHODS IN FLUIDS*, Volume: 78, Issue: 9, Pages: 552-580, ISSN: 02712091, eISSN: 10970363, 2015
9. Boboescu, IZ., Gherman, VD., Ilie, M., Lakatos, G., Pap, B., Negrea, A., Kondorosi, E., Maroti, G. Converting organic-rich industrial wastewater into biohydrogen through a novel hybrid dark fermentation—photoheterotrophic approach: Proof of concept, *JOURNAL OF BIOTECHNOLOGY*, Volume: 208, Pages: S33-S33, Supplement: S, 2015;
10. Boeriu, CG., Fitigau, FI., Gosselink, RJA., Frissen, AE., Stoutjesdijk, J., Peter, F. Fractionation of five technical lignins by selective extraction in green solvents and characterisation of isolated fractions, *INDUSTRIAL CROPS AND PRODUCTS*, Volume: 62, Pages: 481-490, 2014;
11. Butnariu, M., Negrea, P., Lupa, L., Ciopec, M., Negrea, A., Pentea, M., Sarac, I., Samfira, I. Remediation of Rare Earth Element Pollutants by Sorption Process Using Organic Natural Sorbents, *INTERNATIONAL JOURNAL OF ENVIRONMENTAL RESEARCH AND PUBLIC HEALTH*, Volume: 12, Issue: 9, Pages: 11278-11287, ISSN: 16604601, 2015;
12. Cazacu, MM., Nicolae, D., Talianu, C., Belegante, L., Vetres, I., Biniotoglou, I. Optical, size and mass properties of mixed type aerosols in Greece and Romania as observed by synergy of lidar and sunphotometers combination with model simulations: A case study, *SCIENCE OF THE TOTAL ENVIRONMENT*, Volume: 500, Pages: 277-294, 2015;

13. Caruntu, B., Bota, C. Polynomial Least Squares Method for the Solution of Nonlinear Volterra-Fredholm Integral Equations, *MATHEMATICAL PROBLEMS IN ENGINEERING*, Article Number: 147079, 2014;
14. Cioabla, A.E., Pop, N., Calinoiu, D.G., Trif-Tordai, G. An experimental approach to the chemical properties and the ash melting behavior in agricultural biomass, *JOURNAL OF THERMAL ANALYSIS AND CALORIMETRY*, Volume: 121, Issue: 1, Pages: 421-427, ISSN: 13886150, eISSN: 15728943, 2015;
15. Ciocan, T., Susan-Resiga, R., Muntean, S. Improving Draft Tube Hydrodynamics over a Wide Operating Range, *PROCEEDINGS OF THE ROMANIAN ACADEMY SERIES A-MATHEMATICS PHYSICS TECHNICAL SCIENCES INFORMATION SCIENCE*, Volume: 15, Issue: 2, Pages: 182-190, 2014;
16. Cretu, C., Cseh, L., Tang, B.J., Sasca, V., Badea, V., Szerb, E.I., Mehl, G., Shova, S., Costisor, O. Mononuclear Cu(II) complexes of novel salicylidene Schiff bases: synthesis and mesogenic properties, *LIQUID CRYSTALS*, Volume: 42, Issue: 8, Pages: 1139-1147, ISSN: 02678292, eISSN: 13665855, 2015;
17. Curiac, D.I., Volosencu, C. Imparting protean behavior to mobile robots accomplishing patrolling tasks in the presence of adversaries, *BIOINSPIRATION & BIOMIMETICS*, Volume: 10, Issue: 5, 2015;
18. Daianu, D. Recursive procedure in the stability of Fréchet polynomials, *ADVANCES IN DIFFERENCE EQUATIONS*, Article Number: 16, 2014;
19. Dascalu, D., Pitulice, L., Ionel, R., Bizerea-Spiridon, O. The usage of a zeolitic composite for quality improvement of copper contaminated mining wastewaters, *INTERNATIONAL JOURNAL OF ENVIRONMENTAL SCIENCE AND TECHNOLOGY*, Volume: 12, Issue: 7, Pages: 2285-2298, ISSN: 17351472, eISSN: 17352630, 2015;
20. Dubina, D., Ungureanu, V., Gilia, L. Experimental investigations of cold-formed steel beams of corrugated web and built-up section for flanges, *THINWALLED STRUCTURES*, Volume: 90, Pages: 159-170, ISSN: 02638231, eISSN: 18793223, 2015;
21. Dumitrache, F., Morjan, I., Fleaca, C., Badoi, A., Manda, G., Pop, S., Marta, D.S., Humnic, G., Humnic, A., Vekas, L., Daia, C., Marinica, O., Luculescu, C., Niculescu, A.M. Highly magnetic Fe₂O₃ nanoparticles synthesized by laser pyrolysis used for biological and heat transfer applications Highly magnetic Fe₂O₃ nanoparticles synthesized by laser pyrolysis used for biological and heat transfer applications, *APPLIED SURFACE SCIENCE*, Volume: 336, Pages: 297-303, 2015;
22. Ene, R.D., Marinca, V. Approximate solutions for steady boundary layer MHD viscous flow and radiative heat transfer over an exponentially porous stretching sheet, *APPLIED MATHEMATICS AND COMPUTATION*, Volume: 269, Pages: 389-401, ISSN: 00963003, eISSN: 18735649, 2015;
23. Fagadar-Cosma, E., Vlascici, D., Fagadar-Cosma, G., Palade, A., Lascu, A., Creanga, I., Birdeanu, M., Cristescu, R., Cernica, I. A Sensitive A(3)B Porphyrin Nanomaterial for CO₂ Detection, *MOLECULES*, Volume: 19, Issue: 12, Pages: 21239-21252, 2014;
24. Gherman, V.D., Boboescu, I.Z., Ilie, M., Molnar, P., Hulka, I., Maroti, G. Pilot bioreactor system for rapid test of different industrial wastewater efficiency in hydrogen production through dark fermentation, *JOURNAL OF BIOTECHNOLOGY*, Volume: 208, Pages: S118-S118, European Biotechnology Congress, May 2015, Bucharest, Romania, ISSN: 01681656, eISSN: 18734863, Published 2015;
25. Hadaruga, D.I., Costescu, C.I., Corpas, L., Hadaruga, N.G., Isengard, H.D. Differentiation of rye and wheat flour as well as mixtures by using the kinetics of Karl Fischer water titration, *FOOD CHEMISTRY*, Volume: 195, Pages: 49-55, 2015;
26. Hadaruga, D.I., Hadaruga, N.G., Costescu, C.I., David, I., Gruia, A.T. Thermal and oxidative stability of the *Ocimum basilicum* L. essential oil/beta-cyclodextrin supramolecular system, *BEILSTEIN JOURNAL OF ORGANIC CHEMISTRY*, Volume: 10, Pages: 2809-2820, 2014;
27. Heghes, A., Hadaruga, N.G., Fulas, A.V., Bandur, G.N., Hadaruga, D.I., Dehelean, C.A. Capsicum annum extracts/beta-cyclodextrin complexes Thermal analyses-Karl Fischer water titration correlations and antioxidant activity, *JOURNAL OF THERMAL ANALYSIS AND CALORIMETRY*, Volume: 120, Issue: 1, Pages: 603-615, 2015;
28. Herisanu, N.; Marinca, V.; Madescu, Gh. An analytical approach to non-linear dynamical model of a permanent magnet synchronous generator, *WIND ENERGY*, Volume: 18, Issue: 9, Pages: 1657-1670, 2015;

29. Ianos, R., Lazau, R., Borcanescu, S., Babuta, R. Single-step combustion synthesis of YAlO₃ powders, JOURNAL OF MATERIALS SCIENCE, Volume: 50, Issue: 19, Pages: 6382-6387, 2015;
30. Ianos, R., Lazau, R., Boruntea, R.C., Solution combustion synthesis of bluish-green BaAl₂O₄: Eu²⁺, Dy³⁺ phosphors, CERAMICS INTERNATIONAL, Volume: 41, Issue: 2, Pages: 3186-3190, ISSN: 02728842, eISSN: 18733956, 2015;
31. Ianos, R., Taculescu, EA., Pacurariu, C., Niznansky, D. gamma-Fe₂O₃ nanoparticles prepared by combustion synthesis, followed by chemical oxidation of residual carbon with H₂O₂, MATERIALS CHEMISTRY AND PHYSICS, Volume: 148, Issue: 3, Pages: 705-711, 2014;
32. Ilescu, S., Ilia, G., Popa, A., Plesu, N., Macarie, L., Davidescu, CM. Interfacial polycondensation method used in the synthesis of polymers containing phosphorus in the main chain, PURE AND APPLIED CHEMISTRY, Volume: 86, Issue: 11, Pages: 1675-1683, 2014;
33. Ionel, R., Pitulice, L, Vasii, G., Mischie, S., Spiridon, O.B. Implementation of a GPRS based remote water quality analysis instrumentation, MEASUREMENT, Volume: 65, Pages: 81-93, ISSN: 02632241, eISSN: 1873412X, 2015;
34. Jivulescu, M.A., Lupa, N., Nechita, I., Reeb, D. Positive reduction from spectra, LINEAR ALGEBRA AND ITS APPLICATIONS, Volume: 469, Pages: 276-304, ISSN: 00243795, ISSN: 18731856, 2015;
35. Kiss, ML., Chirita, M., Banica, R., Ieta, A., Savii, C., Grozescu, I. Transition from single crystalline FeCO₃ to layered and ordered nanostructured alpha-Fe₂O₃, MATERIALS LETTERS, Volume: 158, Pages: 214-217, 2015;
36. Ledeti, I., Alexa, A., Bercean, V., Vlase, G., Vlase, T., Suta, LM., Fulias, A. Synthesis and Degradation of Schiff Bases Containing Heterocyclic Pharmacophore, INTERNATIONAL JOURNAL OF MOLECULAR SCIENCES, Volume: 16, Issue: 1, Pages: 1711-1727, ISSN: 14220067, 2015;
37. Ledeti, I., Vlase, G., Vlase, T., Bercean, V., Fulias, A. Kinetic of solid-state degradation of transitional coordinative compounds containing functionalized 1,2,4-triazolic ligand, JOURNAL OF THERMAL ANALYSIS AND CALORIMETRY, Volume: 121, Issue: 3, Pages: 1049-1057, 2015;
38. Ledeti, I., Vlase, G., Vlase, T., Suta, LM., Todea, A., Fulias, A. Selection of solid-state excipients for simvastatin dosage forms through thermal and nonthermal techniques, JOURNAL OF THERMAL ANALYSIS AND CALORIMETRY, Volume: 121, Issue: 3, Pages: 1093-1102, 2015;
39. Lelea, D., Laza, I. The particle thermal conductivity influence of nanofluids on thermal performance of the microtubes, INTERNATIONAL COMMUNICATIONS IN HEAT AND MASS TRANSFER, Volume: 59, Pages: 61-67, 2014;
40. Lemle, LD. On the Uniqueness of Symmetric Diffusion Operators on Complete Non-Compact Riemannian Manifolds, JOURNAL OF GEOMETRIC ANALYSIS, Volume: 25, Issue: 4, Pages: 2375-2385, 2015;
41. Lupa, L., Negrea, A., Ciopec, M., Negrea, P., Voda, R. Ionic liquids impregnated onto inorganic support used for thallium adsorption from aqueous solutions, SEPARATION AND PURIFICATION TECHNOLOGY, Volume: 155, Pages: 75-82, 2015;
42. Marinca, V., Ene, R.D., Marinca, B. Approximate Analytic Solutions of a Nonlinear Elastic Wave Equations With The Anharmonic Correction, PROCEEDINGS OF THE ROMANIAN ACADEMY SERIES AMATHEMATICS PHYSICS TECHNICAL SCIENCES INFORMATION SCIENCE, Volume: 16, Issue: 1, Pages: 80-86, ISSN: 14549069, 2015;
43. Marsavina, L., Constantinescu, DM., Linul, E., Apostol, DA., Voiconi, T., Sadowski, T. Refinements on fracture toughness of PUR foams, ENGINEERING FRACTURE MECHANICS, Volume: 129, Pages: 54-66, Special Issue: SI, 2014;
44. Mitelea, I., Bordeasu, I., Pelle, M., Craciunescu, C. Ultrasonic cavitation erosion of nodular cast iron with ferrite-pearlite microstructure, ULTRASONICS SONOCHEMISTRY, Volume: 23, Pages: 385-390, ISSN: 13504177, eISSN: 18732828, 2015;

45. Mitelea, I., Dimian, E., Bordeasu, I., Craciunescu, C. Cavitation Erosion of Laser Nitrided Ti6Al4V Alloys with the Energy Controlled by the Pulse Duration, *TRIBOLOGY LETTERS*, Volume: 59, Issue: 2, ISSN: 10238883, eISSN: 15732711, 2015;
46. Mitelea, I., Ghera, C., Bordeasu, I., Craciunescu, C.M. Ultrasonic cavitation erosion of a duplex treated 16MnCr5 steel, *INTERNATIONAL JOURNAL OF MATERIALS RESEARCH*, Volume: 106, Issue: 4, Pages: 391-397, ISSN: 18625282, eISSN: 21958556, 2015;
47. Murvay, P.S., Groza, B. Source Identification Using Signal Characteristics in Controller Area Networks, *IEEE SIGNAL PROCESSING LETTERS*, Volume: 21, Issue: 4, Pages: 395-399, 2014;
48. Musuc, A.M., Dumitru, R., Stan, A., Munteanu, C., Birjega, R., Carp, O. Synthesis, characterization and thermoreactivity of some methylcellulose-zinc composites, *JOURNAL OF THERMAL ANALYSIS AND CALORIMETRY*, Volume: 120, Issue: 1, Pages: 85-94, 2015;;
49. Negrea, A., Popa, A., Ciopec, M., Lupa, L., Negrea, P., Davidescu, C.M., Motoc, M., Minzatu, V. Phosphonium grafted styrene-divinylbenzene resins impregnated with iron(III) and crown ethers for arsenic removal, *PURE AND APPLIED CHEMISTRY*, Volume: 86, Issue: 11, Pages: 1729-1740, 2014;
50. Pacurariu, C., Taculescu, E.A., Ianos, R., Marinica, O., Mihali, C.V., Socoliuc, V. Synthesis and characterization of gamma-Fe2O3/SiO2 composites as possible candidates for magnetic paper manufacture, *CERAMICS INTERNATIONAL*, Volume: 41, Issue: 1, Pages: 1079-1085, Part: B, 2015;
51. Pap, B., Gyorkei, A., Boboescu, I.Z., Nagy, I.K., Biro, T., Kondorosi, E., Maroti, G. Temperature-dependent transformation of biogas-producing microbial communities points to the increased importance of hydrogenotrophic methanogenesis under thermophilic operation, *BIORESOURCE TECHNOLOGY*, Volume: 177, Pages: 375-380, 2015;
52. Papayannis, A., Nicolae, D., Kokkalis, P., Biniotoglou, I., Talianu, C., Belegante, L., Tsaknakis, G., Cazacu, M.M., Vetres, I., Ilic, L. Optical, size and mass properties of mixed type aerosols in Greece and Romania as observed by synergy of lidar and sunphotometers in combination with model simulations: A case study, *SCIENCE OF THE TOTAL ENVIRONMENT*, Volume: 500, Pages: 277-294, 2014;
53. Parvulescu, V., Popa, A., Paun, G., Ene, R., Davidescu, C.M., Iliu, G. Effect of polymer support functionalization on enzyme immobilization and catalytic activity, *PURE AND APPLIED CHEMISTRY*, Volume: 86, Issue: 11, Pages: 1793-1803, 2014;
54. Paska, O.M., Pacurariu, C., Muntean, S.G. Kinetic and Thermodynamic Studies on Methylene Blue Biosorption using Corn-Husk, *RSC ADVANCES*, Volume: 4, Issue: 107, Pages: 62621-62630, 2014;
55. Popa, A., Ciopec, M., Negrea, A., Lupa, L., Negrea, P., Davidescu, C.M., Iliu, G., Duteanu, N. Use of styrene-divinylbenzene grafted with aminoethyl-aminomethyl groups and various ionic liquids in the removal process of thallium and strontium, *PURE AND APPLIED CHEMISTRY*, Volume: 86, Issue: 11, Pages: 1741-1753, 2014;
56. Pozna, C., Precup, R.E., Foldesi, P. A novel pose estimation algorithm for robotic navigation, *ROBOTICS AND AUTONOMOUS SYSTEMS*, Volume: 63, Pages: 1021, ISSN: 09218890, eISSN: 1872793X, 2015;
57. Precup, R.E., Sabau, M.C., Petriu, E.M. Nature inspired optimal tuning of input membership functions of Takagi Sugeno Kang fuzzy models for Antilock Braking Systems, *APPLIED SOFT COMPUTING*, Volume: 27, Pages: 575-589, ISSN: 15684946, eISSN: 18729681, 2015;
58. Precup, R.E., Tomescu, M.L. Stable fuzzy logic control of a general class of chaotic systems, *NEURAL COMPUTING & APPLICATIONS*, Volume: 26 Issue: 3, Special Issue: SI, Pages: 541-550, 2015;
59. Precup, R.E., David, R.C., Petriu, E.M., Preitl, S., Radac, M.B. Novel Adaptive Charged System Search algorithm for optimal tuning of fuzzy controllers, *EXPERT SYSTEMS WITH APPLICATIONS*, Volume: 41, Issue: 4, Pages: 1168-1175, Part: 1, 2014;
60. Precup, R.E., Petriu, E.M., Radac, M.B., Preitl, S., Fedorovici, L.O., Dragos, C.A. Cascade Control System-Based Cost Effective Combination of Tensor Product Model Transformation and Fuzzy Control, *SIAN JOURNAL OF CONTROL*, Volume: 17, Issue: 2, Pages: 381-391, 2015;

61. Radac, MB., Precup, R.E. Data-based two-degree-of-freedom iterative control approach to constrained non-linear systems, IET CONTROL THEORY AND APPLICATIONS, Volume: 9, Issue: 7, Pages: 1000-1010, 2015;
62. Radac, MB., Precup, R.E., Petriu, E.M. Model-Free Primitive-Based Iterative Learning Control Approach to Trajectory Tracking of MIMO Systems With Experimental Validation, IEEE TRANSACTIONS ON NEURAL NETWORKS AND LEARNING SYSTEMS, Volume: 26, Issue: 11, Pages: 2925-2938, 2015;
63. Sarbu, I., Adam, M. Experimental and numerical investigations of the energy efficiency of conventional air conditioning systems in cooling mode and comfort assurance in office buildings, ENERGY AND BUILDINGS, Volume: 85, Pages: 45-58, 2014;
64. Sarbu, I., Pacurar, C. Experimental and numerical research to assess indoor environment quality and schoolwork performance in university classrooms, BUILDING AND ENVIRONMENT, Volume: 93, Pages: 141-154, Part: 2, 2015
65. Sarbu, I., Valea, E.S. Water pool boiling heat transfer enhancement for modified surface tubes, INTERNATIONAL COMMUNICATIONS IN HEAT AND MASS TRANSFER, Volume: 50, Pages: 61-67, 2014;
66. Sarbu, I.; Sebarchievici, C., General review of solar-powered closed sorption refrigeration systems, ENERGY CONVERSION AND MANAGEMENT, Volume. 105, no. 11, (F1=4,380), 2015;
67. Savva, I., Marinica, O., Papatryfonos, CA., Vekas, L., Krasia-Christoforou, T. Evaluation of Electrospun Polymer-Fe₃O₄ Nanocomposite Mats in Malachite Green Adsorption, RSC ADVANCES, Volume: 5, Issue: 21, Pages: 16484-16496, 2015;
68. Sebarchievici, C., Sarbu, I. Performance of an experimental ground-coupled heat pump system for heating, cooling and domestic hot-water operation, RENEWABLE ENERGY, Volume: 76, Pages: 148-159, ISSN: 09601481, 2015;
69. Serban, DA., Linul, E., Voiconi, T., Marsavina, L., Modler, N. Numerical evaluation of two-dimensional micromechanical structures of anisotropic cellular materials: case study for polyurethane rigid foams, IRANIAN POLYMER JOURNAL, Volume: 24, Issue: 6, Pages: 515-529, 2015;
70. Serban, DA., Marsavina, L., Modler, N. Low-cycle fatigue behaviour of polyamides, FATIGUE & FRACTURE OF ENGINEERING MATERIALS & STRUCTURES, Volume: 38 Issue: 11, Pages: 1383-1394, Special Issue: SI, 2015;
71. Stefanescu, M., Bozdog, M., Muntean, C., Stefanescu, O., Vlase, T. Synthesis and magnetic properties of Co_{1-x}Zn_xFe₂O₄ (x=0 divided by 1) nanopowders by thermal decomposition of Co(II), Zn(II) and Fe(III) carboxylates, JOURNAL OF MAGNETISM AND MAGNETIC MATERIALS, Volume: 393, Pages: 92-98, 2015;
72. Stefanescu, M., Sorescu, S., Susan-Resiga, D., Stefanescu, O., Vlase, G. Obtaining of NiO/SiO₂ by thermal decomposition of Ni(II) carboxylates formed within hybrid silica gels, : JOURNAL OF THERMAL ANALYSIS AND CALORIMETRY, Volume: 121, Issue: 1, Pages: 135-144, ISSN: 13886150, eISSN: 15728943, 2015;
73. Stoia, M., Muntean, C., Militaru, B. Fine MnFe₂O₄ nanoparticles for potential environmental applications Synthesis and characterization Journal of Thermal Analysis and Calorimetry, Volume: 121, Issue: 3, Pages: 1003-1010, ISSN: 13886150, eISSN: 15728943, 2015;
74. Stoia, M., Pacurariu, C., Istrate, R., Niznansky, D. Solvothermal synthesis of magnetic Fe_xO_y/C nanocomposites used as adsorbents for the removal of methylene blue from wastewater, Journal of Thermal Analysis and Calorimetry, Volume: 121, Issue: 3, Pages: 989-1001, ISSN: 13886150, eISSN: 15728943, 2015;
75. Sun, GH., Popov, D., Camacho-Nieto, O., Dong, SH. Shannon information entropies for position-dependent mass Schrodinger problem with a hyperbolic well, CHINESE PHYSICS B, Volume: 24, Issue: 10, 2015;
76. Tiwari, AK., Mutascu, M., Albulescu, CT., Kyophilavong, P. Frequency domain causality analysis of stock market and economic activity in India, INTERNATIONAL REVIEW OF ECONOMICS & FINANCE, Volume: 39, Pages: 224-238, 2015;

77. Todea, A., Biro, E., Badea, V., Paul, C., Cimporescu, A., Nagy, L., Keki, S., Bandur, G., Boeriu, C., Peter, F. Optimization of enzymatic ring-opening copolymerizations involving delta-gluconolactone as monomer by experimental design, *PURE AND APPLIED CHEMISTRY*, Volume: 86, Issue: 11, Pages: 1781-1792, 2014;
78. Todea, A., Otten, L.G., Frissen, A.E., Arends, I.W.C.E., Peter, F., Boeriu, C.G. Selectivity of lipases for estolides synthesis, *PURE AND APPLIED CHEMISTRY*, Volume: 87, Issue: 1, Pages: 51-58, ISSN: 00334545, eISSN: 13653075, 2015;
79. Todut, C., Dan, D., Stoian, V. Numerical and experimental investigation on seismically damaged reinforced concrete wall panels retrofitted with FRP composites, *COMPOSITE STRUCTURES*, Volume: 119, Pages: 648-665, ISSN: 02638223, eISSN: 18791085, 2015;
80. Totorean, AF., Bosioc, AI., Bernad, SI., Susan-Resiga, R. Critical Flow Regions in the Coronary By-Pass Graft Anastomosis, *PROCEEDINGS OF THE ROMANIAN ACADEMY SERIES A-MATHEMATICS PHYSICS TECHNICAL SCIENCES INFORMATION SCIENCE*, Volume: 16, Issue: 2, Pages: 201-208, 2015;
81. Totorean, AF., Bernad, SI., Susan-Resiga, R. Fluid Dynamics in Helical Geometries with Applications for By-Pass Grafts, *APPLIED MATHEMATICS AND COMPUTATION*, Volume: 272, Pages: 604-613, Part: 3, 2015;
82. Ungurean, M., Csanadi, Z., Gubicza, L., Peter, F. An Integrated Process of Ionic Liquid Pretreatment and Enzymatic Hydrolysis of Lignocellulosic Biomass with Immobilised Cellulase, *BIORESOURCES*, Volume: 9, Issue: 4, Pages: 6100-6116, 2014;
83. Ursu, D., Miclau, M., Banica, R., Vaszilcsin, N. Impact of Fe doping on performances of CuGaO₂ p-type dye-sensitized solar cells, *MATERIALS LETTERS*, Volume: 143, Pages: 91-93, ISSN: 0167577X, eISSN: 18734979, 2015;
84. Utu, ID., Marginean, G., Hulka, I., Serban, VA., Cristea, D. Properties of the thermally sprayed Al₂O₃-TiO₂ coatings deposited on titanium substrate, *INTERNATIONAL JOURNAL OF REFRACTORY METALS & HARD MATERIALS*, Volume: 51, Pages: 118-123, 2015;
85. Vlazan, P., Ursu, D.H., Irina Moisescu, C., Miron, I., Sfirloaga, P., Rusu, E. Structural and electrical properties of TiO₂/ZnO core-shell nanoparticles synthesized by hydrothermal method, *MATERIALS CHARACTERIZATION*, Volume: 101, Pages: 153-158, ISSN: 10445803, eISSN: 18734189, 2015;
86. Yi, J.Z., Mao, X., Chen, L.J., Xue, Y.L., Rovetta, A., Căleanu, C.D. Illumination Normalization of Face Image Based on Illuminant Direction Estimation and Improved Retinex, *PLoS One*, Volume: 10, Issue: 4, ISSN: 19326203, 2015;

Projects supported by public funds

Projects supported by public funds

Fields	Total number of projects	Source of financing	Number of projects by source of financing	Number of projects presented
Systems Engineering & Computers and Information Technology	15	National Funds*	12	4
		International Programs**	1	
		Cross-border Cooperation RO-SR	1	
		Cross-border Cooperation HU-RO	1	
Electrical and Power Engineering	2	National Funds*	1	1
Electronic Engineering and Telecommunications	5	National Funds*	1	3
		International Programs**	2	
		POSDRU***	2	
Civil Engineering and Building Services	9	National Funds*	6	8
		International Programs**	3	
Industrial Engineering	3	National Funds*	3	1
Mechanical Engineering	14	National Funds*	8	9
		International Programs**	2	
		POSDRU***	4	
Materials Engineering	5	National Funds*	4	1
		International Programs**	1	
Engineering and Management	4	National Funds*	2	3
		International Programs**	2	
Chemical Engineering	11	National Funds*	11	5
Mathematics	2	National Funds*	1	2
		International Programs**	1	

* National Funds - funds awarded by the Romanian govern through UEFISCDI

** International Programs - EU 7th Framework Program, Research Fund for Coal and Steel or the Information and Communication Technologies Policy Support Program - The European Space Agency (ESA), Leonardo da Vinci, Transfer of Innovation project (LDV-TOI)

*** Structural Funds - European Regional Development Fund, European Social Fund and the Romanian National Authority for Scientific Research-

NOTE: For presentation we have chosen the most relevant projects for our research capacity. The projects are arranged by doctoral studies fields of IOSUD - UPT.

EVOLUTION OF PROJECTS SUPPORTED BY PUBLIC FUNDS IMPLEMENTED BY UPT 2012-2015

Projects supported by public funds

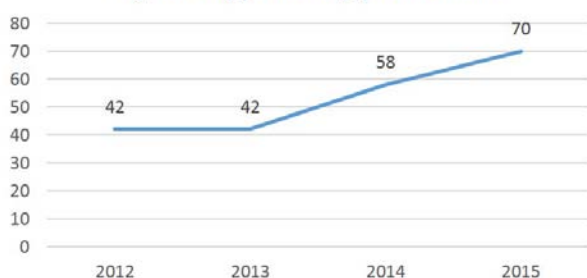

UPT considers that scientific research is a priority of the university mission, conferring personality and distinction to the university, and that reaching excellence in scientific research is a target on medium and long term.

Most of the research activity carried out by our institution is financed through external sources, obtained either from national and international calls for projects. This represents a confirmation of the superior quality of the research, but also of the prestige and professional deontology of the researchers affiliated to our institution.

We have presented the evolution of projects implemented by UPT between 2012 and 2015, total number of projects and projects split by field of implementation (cumulated by doctoral studies fields of IOSUD-UPT).

Projects supported by public funds split by field of implementation

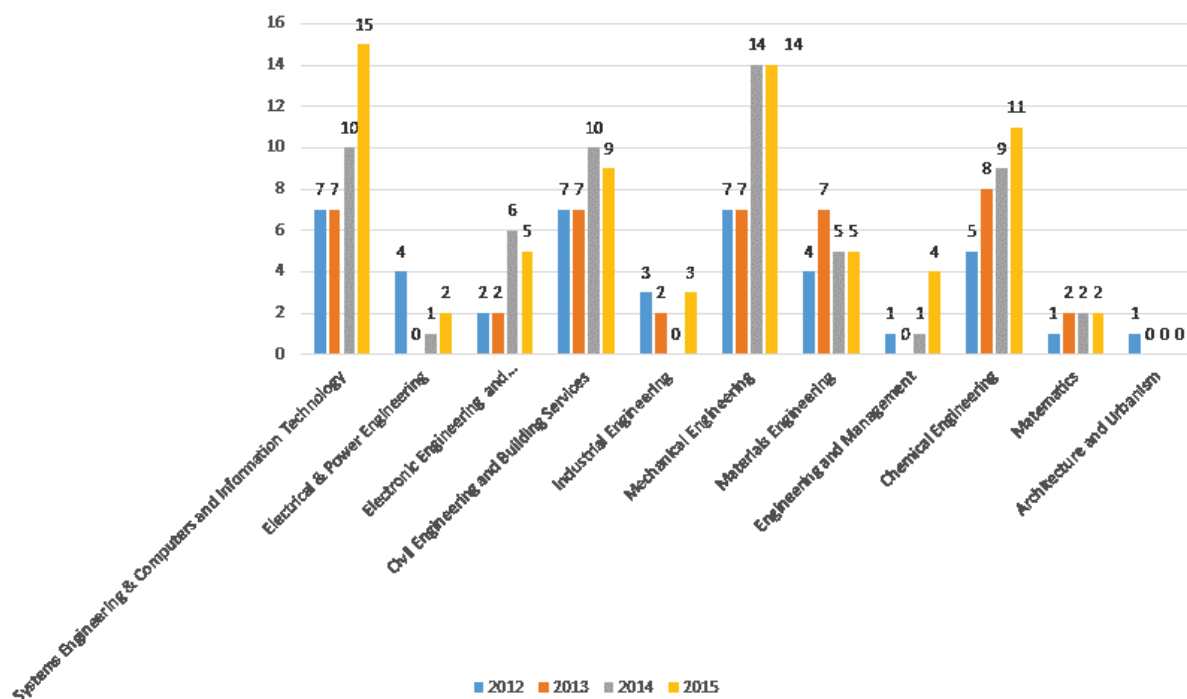

GREENER MOBILE SYSTEMS BY CROSS LAYER INTEGRATED ENERGY MANAGEMENT (GEMSCLAIM)

Goal of the project

The GEMSCLAIM project aims at introducing novel approaches for reducing the “greed for energy” of modern battery powered systems, thereby improving the user experience and enabling new opportunities for mobile computing

Mobile terminals and consumer devices are among the fastest growing markets in computing. In the long term, further growth is endangered by the “power/ energy wall”. The purpose of GEMSCLAIM is to explore new techniques in energy optimization via an interdisciplinary vertical approach: a novel combined optimization across the major HW/SW system layers (compiler/OS/HW platform).

Short description of the project

- The ever-growing need for energy efficient computation requires adequate support for energy-aware thread scheduling that offers insight into a systems behavior for improved application energy/performance optimizations. Runtime accurate monitoring of energy consumed by every component of a multi-core embedded system is an important feature to be considered for future designs. Although, important steps have been made in this direction, the problem of distributing energy consumption among threads executed on different cores for shared components remains an ongoing struggle.
- We aim at designing a generic low-cost and energy efficient hardware infrastructure which supports thread level energy consumption monitoring of hardware components in a multi-core system.
- The proposed infrastructure provides upper layers (operating system and application threads) with per thread and per component energy accounting API (Application Programming Interface), similar with performance profiling functions. Implementation results indicate that the proposed LEM (Load and Energy Monitor) adds around 10% resource overhead to the monitored system. Regarding the power estimates, the one derived by LEM achieve a correlation degree of more than 95% with the ones obtained from physical power measurements.

Project implemented by

Mobile Computing, Sensors Network and Embedded Systems Research Laboratory, Computer and Software Engineering Department, Faculty of Automation and Computers

Implementation period

Sep. 2012–Aug.2015

Main activities

In a world of de-facto standards as well as huge amounts of legacy HW and SW, it is very difficult to achieve real breakthrough in system-wide energy savings beyond fragmented point solutions, e.g. at the HW or OS level.

GEMSCLAIM’s mission is to overcome this hurdle by a novel cross layer energy optimization approach that combines the following major research activities:

- Development of an energy-aware optimizing and parallelizing compiler;
- Component aware energy-efficient operating system and
- Customizable HW modelling with energy monitoring facilities.

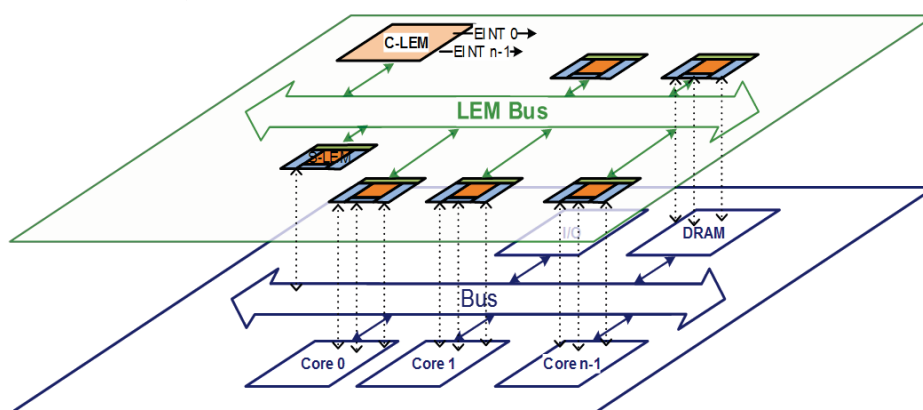

Overall solution architecture

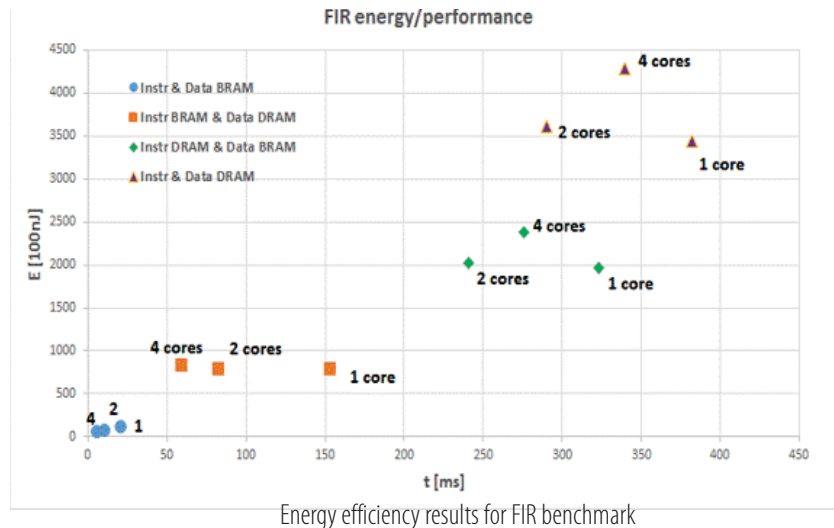

Energy efficiency results for FIR benchmark

Results

The contributions of this work are as follows: (1) hardware infrastructure for dynamic energy consumption monitoring in a heterogeneous multi-core system with per-thread energy accounting; (2) energy interrupt specification and design; (3) a use case on the software side (OS and drivers) for run-time per-thread energy accounting implementation on FPGA; and (4) validation of proposed infrastructure on a high-end FPGA board with physical energy measurements.

Per-thread energy accounting (PTEA) can be achieved by splitting the whole energy into processing energy (energy consumed by processing cores), data movement energy (energy consumed by interconnects to read and store data) and data storage energy (energy consumed by memories to store task data). The proposed infrastructure addresses all of these energy consumers: processing energy accounting, data movement energy accounting, and data storage accounting. Both processing and data movement accounting are performed per thread

In this project, we have introduced a cost effective LEM infrastructure for component level power and energy monitoring by providing adequate hardware and software support for PTEA and energy interrupt. The monitoring infrastructure implements two levels of energy accounting: processing energy and data movement energy. Per core energy accounting can be done using the LEM hardware infrastructure. The infrastructure can be further used in conjunction with OS drivers in order to, to implement thread-level energy accounting at OS level.

We have validated our infrastructure on a Zynq ZC702 evaluation board. We have developed systems consisting of 1 MB core, 2 MB cores, 4 MB cores and 8 MB cores. The results from the execution of WCET benchmarks has indicated a strong correlation between the LEM based energy estimates and the physical power board measurements of more than 95%.

The implementation results indicated that the overall overhead of the proposed infrastructure is around 10%, for 14 sensors attached to 4-cores reference design. The proposed LEM has lower cost with respect to the Xilinx based performance counters, while having increased flexibility and accuracy.

Applicability and transferability of the results

A number of hardware components described in Verilog have been developed and provided as IPs to FPGA community

Financed through/by

CHIST-ERA partnership projects, PNII-IDEI – 1/CHIST-ERA/01.10.2012

Research Centre

Research Center in Computer and Information Technology

Research team

Innsbruck University (LP), Queen's University Belfast, RWTH Aachen University,

Politehnica University of Timisoara:

Assoc. Prof. Marius Marcu
Dr. Oana Boncalo
Dr. Sebastian Fuicu
Dr. Gabriel Garban
Dr. Alexandru Amaricai

Dr. Razvan Bogdan
Dr. Cosmin Cernazanu
Ing. Lucian Bara
Ing. Madalin Ghenea
Ing. Marian Ionascu

Contact information

Assoc. Prof. Marius MARCU, PhD
Department of Computer Science
Address: Str. Bd. Vasile Pârvan, No. 2, RO300223, Timisoara,
Phone: (+40) 256 403263
E-mail: marius.marcu@upt.ro
Web: www.cs.upt.ro/~mmarcu

TIME AND ENERGY EFFICIENT FRAMEWORK FOR INTER-OPERATION OF SMART DEVICES (TEEFIOS)

Goal of the project

Development of an integrated real-time and energy efficient inter-operation framework for networks of smart sensors and devices - TEEFIOS.

Short description of the project

- Wireless networks of sensors and smart devices (WSN) are an extremely interesting topic, at the confluence of engineering fields with enormous impact on worldwide society: digital networks, wireless communications, and miniature embedded digital devices.
- Aware of the severe requirements and challenges raised by current applications in this area, we propose a new paradigm - Time and Energy Efficiency (T: or TEE).

The main proposed objectives focus on three distinct layers:

- (a) T:Node, a hardware-software environment and methodology for designing and assessing real-time behavior and efficient energy consumption of embedded devices,
- (b) T:YNet, a system for the development and analysis of TEE communication in wireless ad-hoc networks, and
- (c) T:Pilot, a methodology for the power management of the entire network. An integrated set of tools, benchmarks and databases will also be created to help advanced developers and researchers in the WSN area apply the TEE paradigm to applications with high impact.

Project implemented by

- DSPLabs - Digital Signal Laboratories Timisoara, Department of Computer and Software Engineering, Politehnica University of Timisoara.

Implementation period

01.10.2015 - 30.09.2017 (24 months)

Grant value

548850 RON (~123337 EUR)

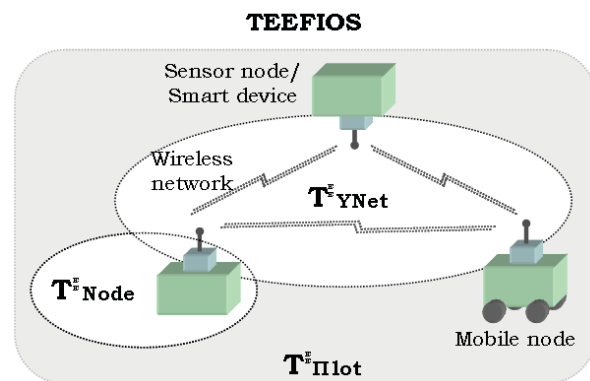

Main activities

- Energy consumption model and taxonomy for smart devices;
- Energy optimization real-time scheduling mechanism for smart devices;
- Methodology for node-level energy consumption assessment;
- Real-Time MAC protocol for ad-hoc wireless networks;
- Flexible real-time wireless module for smart devices;
- Framework for real-time communication in WSNs;
- Global power management methodology for networks of smart devices;
- Case studies to validate the TEEFIOS framework;
- Integrated set of databases and web-based tools;
- Information exchange, results dissemination and publication.

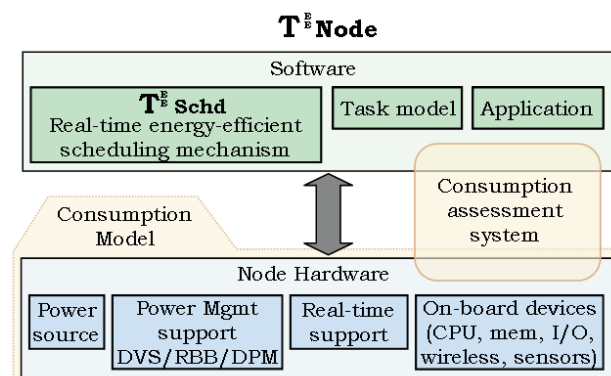

Results

- Integrated set of consumption models for smart devices;
- T:Schd, a real-time scheduling technique which optimizes energy consumption;
- Hardware/software methodology for the consumption evaluation of smart devices;
- Database with the energy efficiency evaluation and classification results for different types of smart devices;
- Real-time MAC protocol for ad-hoc wireless networks;
- Functional prototype of a flexible real-time wireless module for smart devices;
- A framework and a set of metrics for the evaluation of real-time wireless communication applications;
- A simulation testbed to evaluate the scalability of time and energy efficient WSN applications;
- T:Plot, a global power management methodology for networks of smart devices;
- A collection of case studies that demonstrate the validity of the proposed framework and its individual components;
- An integrated set of web and database tools for public-level information and access to the TEEFIOS framework services.

Applicability and transferability of the results

- The real-time and energy efficient interoperation framework, along with the associated tool set and databases, will be of valuable use to the advanced developers and researchers in the field of wireless sensor/smart device networks.
- The results of this project will help them apply the TEE paradigm to applications with high impact in scientific, social, economic and environmental areas, such as: disaster recovery, smart buildings and structures, environment monitoring, smart energy grids and metering, robotic collectives, industrial process control, smart vehicles and transportation, security and surveillance.

Fields of interest

- Real-time systems;
- Energy efficiency;
- Sensors and smart devices;
- Wireless communication;
- Ad-hoc networks.

Financed through/by

UEFISCDI, Romanian Ministry of Education and Research, Bucharest, Romania.

Research team

Project director:
Prof. Dr. Eng. Mihai V. Micea

R&D team:
Prof. Dr. Eng. Vladimir Cretu,
A/Prof. Dr. Eng. Dan Pescaru,
Lect. Dr. Eng. Răzvan Cioargă,
T/Assist. Dr. Eng. Valentin Stângaciu,
T/Assist. Dr. Eng. Cristina Stângaciu,
PhD Stud. Eng. Lucian Ungurean,
Eng. Claudia Micea;
Eng. Adriana R. Tirnovan.

Contact information

Prof. Mihai MICEA, PhD
Department of Computer Science
Address: Str. Bd. Vasile Pârvan, No. 2, RO300223, Timisoara,
Phone: (+40) 256 403271
Fax: (+40) 256 403214
E-mail: mihai.micea@upt.ro
Web: <http://dsplabs.cs.upt.ro/grants/teefios/>

CONTROL ALGORITHMS AND OPTIMAL TUNING OF FUZZY MODELS FOR AUTOMOTIVE, MECHATRONICS APPLICATIONS AND MOBILE ROBOTS

Goal of the project

Development of control structures and algorithms and optimal tuning of fuzzy models for a wide range of industrial processes, mechatronics, mobile robots and automotive applications.

Short description of the project

The project aims:

- Advanced control structures for automotive and mechatronics applications.
- Improvement and development of new Takagi-Sugeno (T-S) fuzzy models and control solutions for a wide range of industrial processes.
- Optimal tuning of fuzzy models for automotive and mechatronics applications.
- Improvement and development of control algorithms for mobile robots.

Project implemented by

"Gheorghe Asachi" Technical University of Iasi (TUIASI) – Coordinator;
Politehnica University of Timisoara, Department of Automation and Applied Informatics – Project Partner P1;
S.C. ROMUS Trading & Development SRL – Project Partner P2.

Implementation period

2012–2016

Main activities

- Design of low-cost T-S state feedback fuzzy controllers for the position control of a class of nonlinear servo systems.
- Sensitivity analysis with respect to the process parametric variations in the low-cost controller designs for vehicle power train systems with spark-ignition engine and continuously variable transmission.
- Modelling, simulation, analysis and design of linear, fuzzy and variable structure control solutions for direct current electric drive systems with continuously variable reference input, variable moment of inertia and variable load disturbance input, applicable to rolling mills and to strip winding systems.
- Development and experimental validation of simple T-S fuzzy models for several processes in automotive and mechatronics: anti-lock braking systems, nonlinear DC drive servo systems, magnetic levitation systems, electromagnetic actuated clutch systems, inverted pendulums.
- Fuzzy logic control algorithms that stabilize chaotic dynamical systems.

- Frequency domain design of fractional order proportional-integral controllers for lambda control in the framework of automotive engine control systems.
- Development of two-degree-of-freedom linear and fuzzy controllers, of hybrid T-S fuzzy controllers, of hybrid PI neuro-fuzzy controllers and of adaptive sliding mode fuzzy controllers for speed and position control of brushless DC drives with variable parameters – continuously variable reference input (speed), variable moment of inertia and variable load disturbance.
- Optimal tuning of parameters of T-S fuzzy models using nature-inspired algorithms (simulated annealing, particle swarm optimization and gravitational search algorithms) and evolving fuzzy modelling.
- Continuous development of the nRobotic platform in the framework of path planning and collision avoidance for mobile robots in missions.
- Development and testing of path planning algorithms for mobile robots using nature-inspired optimization algorithms.

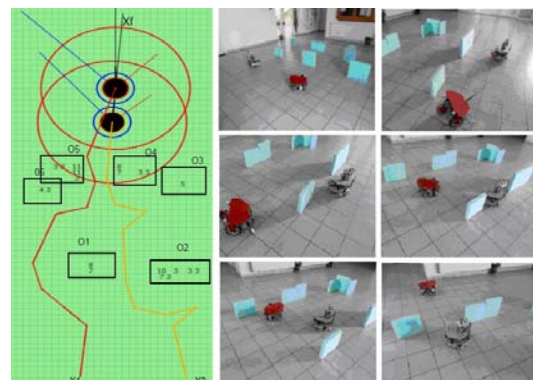

Results

- 20 papers published in ISI journals with impact factors.
- 3 papers published in journals indexed by international databases.
- 7 book chapters published in Springer-Verlag volumes.
- 20 papers published in conference proceedings indexed by international databases (IEEE Xplore, INSPEC, DBLP, Scopus).
- more than 50 independent citations in 2014.

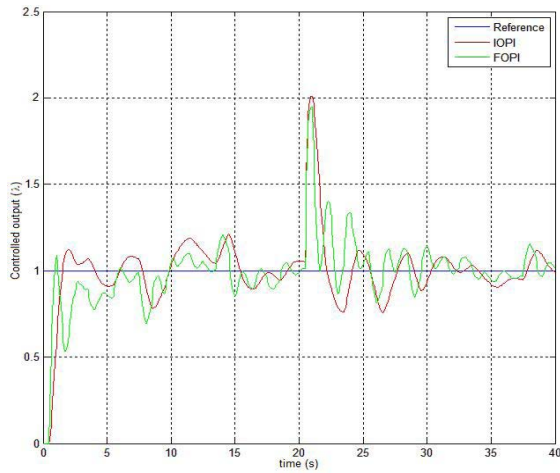

Applicability and transferability of the results

Nature-inspired optimization algorithms in modelling and control design, low-cost solutions for control problems in mechatronics, electrical drives, automotive and robotics, tools for the modelling, optimization and design of fuzzy control systems, real-time programming and operating systems for control and robotics.

Financed through/by

Executive Agency for Higher Education, Research, Development and Innovation Funding – UEFISCDI, Bucharest, Romania.

Research Centre

CCISA - Research Centre for Automatic Systems Engineering

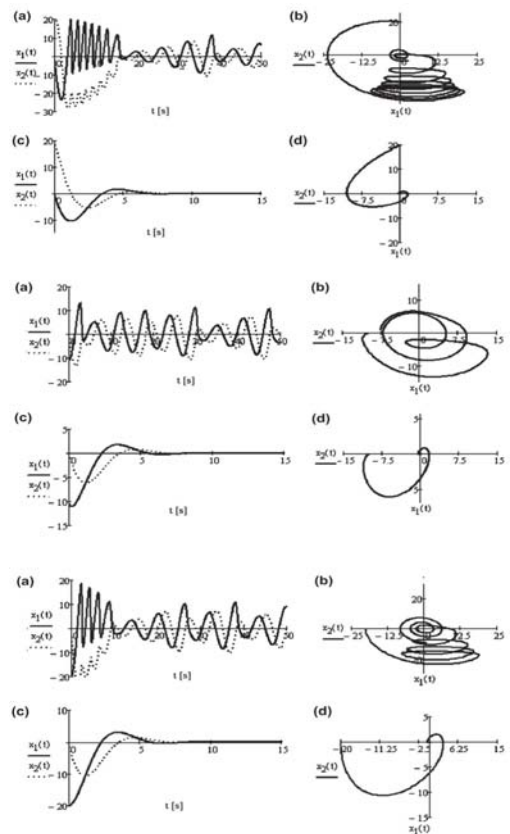
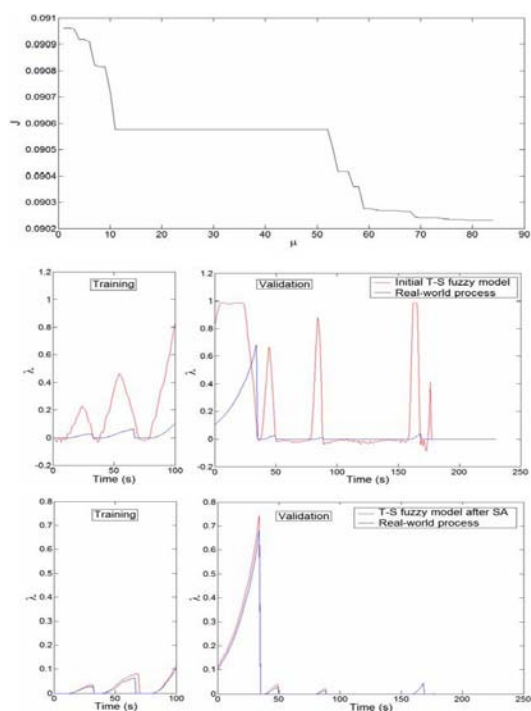

Research team

Prof. Dr. Ing. Radu-Emil Precup – director
 Prof. Dr. Ing. Stefan Preitl
 Prof. Dr. Ing. Ioan Filip
 Assoc. Prof. Dr. Ing. Florin Drăgan
 Lect. Dr. Ing. Adriana Albu
 Lect. Dr. Ing. Ovidiu Baniș
 Lect. Dr. Ing. Daniel Ierican
 Assist. Lect. Dr. Ing. Claudia-Adina Dragoș
 Assist. Lect. Dr. Ing. Mircea-Bogdan Rădac
 Dr. Ing. Alexandra-Lulia Stînean
 PhD student M.Sc. Ing. Lucian-Ovidiu Fedorovici
 PhD student M.Sc. Ing. Constantin Purcaru

Contact information

Prof. Radu-Emil PRECUP, PhD
 Director of the CCISA Research Centre
 Department of of Automation and Applied Informatics
 Address: Str. Bd. Vasile Pârvan, No. 2, RO300223, Timisoara,
 Phone: (+40) 256 403 229
 Fax: (+40) 256 403 214
 E-mail: radu.precup@upt.ro
 Web: <http://www.aut.upt.ro/centru-cercetare/index.EN.php>

NEW PERFORMANCE IMPROVEMENT TECHNIQUES OF CONTROL SYSTEMS USING EXPERIMENT-BASED TUNING

Goal of the project

Enhance the existing techniques and develop new techniques dedicated to the improvement of control system performance using experimental data

Short description of the project

The project aims:

- Enhancement and development of data-based (data-driven) techniques and algorithms for improving control system performances using experimental data.
- Enhancement and development of nature-inspired algorithms in optimization of control system performance.
- Development of optical character recognition (OCR) applications.
- Development of new fuzzy control solutions for a wide range of industrial processes

Project implemented by

Department of Automation and Applied Informatics

Implementation period

2011–2016

Main activities

- Application of Iterative Feedback Tuning (IFT) to controller tuning for nonlinear control systems with constraints.
- Model-Free Adaptive Control strategies applied to multivariable (MIMO) aerodynamic systems.
- An experiment-based approach to Reference Trajectory Tracking optimal control problem with constraints.
- Validation of iterative techniques on laboratory equipment: liquid level control, motion control systems with motor actuation (speed and position control).
- Enhancement of control systems performance by fuzzy control, IFT and nature-inspired optimization algorithms (Charged System Search, Gravitational Search Algorithms).
- PI and fuzzy controller tuning to ensure a reduced sensitivity with respect to the parametric variations of processes.
- Enhancement of the training algorithm of Convolutional Neural Networks using a mixed approach of Back-Propagation and Gravitational Search Algorithm.

Results

- 7 papers published in Thomson Reuters Web of Science (formerly ISI Web of Knowledge) journals with impact factors in 2014.
- 7 papers published in conference proceedings and book chapters indexed in Thomson Reuters Web of Science (formerly ISI Web of Knowledge or ISI Proceedings) in 2014.
- 2 papers published in conference proceedings indexed in international databases (IEEE Xplore, INSPEC, Scopus) in 2014.
- 1 book chapter published in a Springer-Verlag volume.

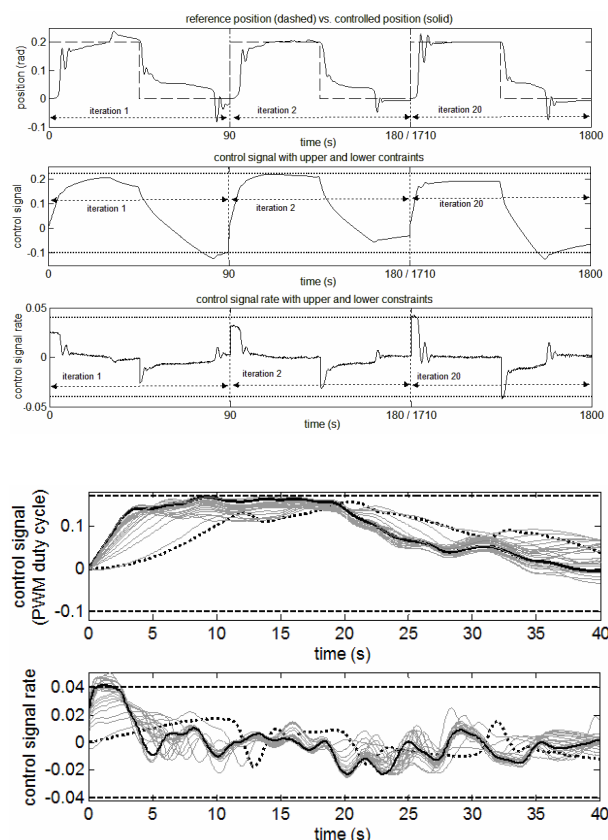

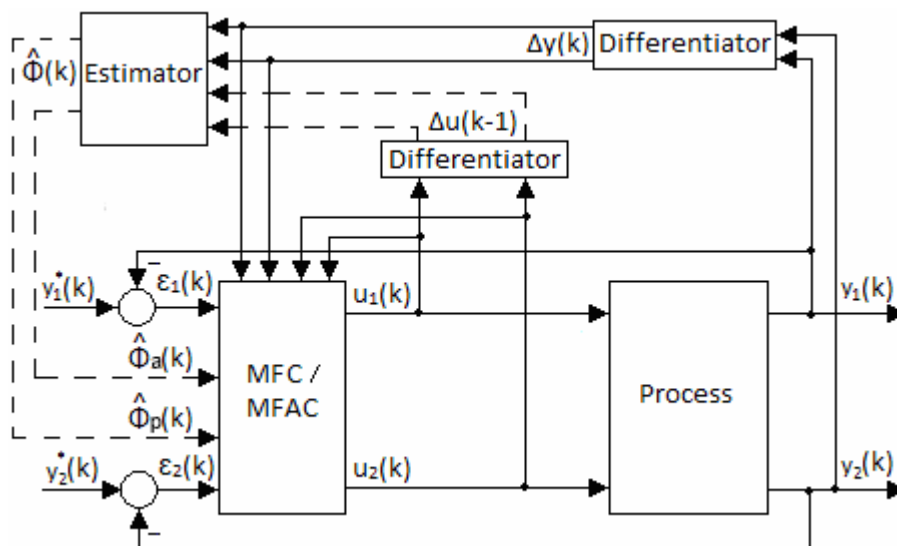

Applicability and transferability of the results

Control systems with a reduced parametric sensitivity, tools for the computer-aided design of controllers, computer-aided techniques in iterative data-based control, nature-inspired optimization algorithms in control design and image processing, tools for the systematic development of fuzzy control systems.

Financed through/by

Executive Agency for Higher Education, Research, Development and Innovation Funding – UEFISCDI, Bucharest, Romania.

Research Centre

CCISA - Research Centre for Automatic Systems Engineering

Research team

Prof. Dr. Ing. Radu-Emil Precup
 Prof. Dr. Ing. Stefan Preitl
 Assoc. Prof. Dr. Ing. Florin Drăgan
 Lect. Dr. Ing. Daniel Iercan
 Lect. Dr. Ing. Mircea-Bogdan Rădac
 Lect. Dr. Ing. Claudia-Adina Bojan-Dragoș
 Assist. Lect. Dr. Ing. Alexandra-Iulia Stînean
 Dipl. Ing. Lucian-Ovidiu Fedorovici

Contact information

Prof. Radu-Emil PRECUP, PhD
 Director of the CCISA Research Centre
 Department of Automation and Applied Informatics
 Address: Str. Bd. Vasile Pârvan, No. 2, RO300223, Timisoara,
 Phone: (+40) 256 403 229
 Fax: (+40) 256 403 214
 E-mail: radu.precup@upt.ro
 Web: <http://www.aut.upt.ro/centru-cercetare/index.EN.php>

HYBRID SYSTEMS FOR CONVERTING RENEWABLE ENERGY OF SMALL VOLTAGE INTEGRATED INTO A MICROGRID

Goal of the project

The project is focused on the research, development and testing of an intelligent and flexible (configurable) small scale power system based on integration of three renewable energy sources: wind, hydro, and solar (photovoltaic) power, adapted to the available resources in Romania, in various regions of the country, working independently or connected to the grid.

Short description of the project

The project will cover the entire power conversion structure, including the design of adequate prime movers and new types of generators and power electronic converters, storage devices, power flow management system and load control. Some configurable structures (wind, micro-hydro and PV, all or a part of them, including their integration in a microgrid) will be proposed as experimental models, ready to be transferred to industry. There are proposed novelty elements regarding: low power wind turbine with integrated overspeed protection system, new generators configurations, and new topologies for power electronic converters and microgrid structures, optimal local control strategies and intelligent power system management.

Project implemented by

Politehnica University of Timisoara – Project coordinator
 Technical University of Cluj-Napoca – Project partner
 SC EETIM SA – Project partner

Implementation period

2012–2016



Main activities

- Microgrid components modeling, simulation and design.
- Microgrid components manufacturing, individual testing and integration in the experimental setup.
- Design, implementation and validation of the control strategies for microgrid components.
- Design, implementation and validation of the microgrid control strategy.
- Results dissemination and know-how exchange



Results

- A new over-speed protection system for wind turbines.
- A new electrical reactive brushless dc generator with performances comparable with high energy PM generator, at low cost.
- A new RF-IPMSG with high efficiency, maintenance-free operation, and high-controllability.
- A new AF-PMSG optimized for modular design. A new multiphase inverter with adequate control for the proposed generators.
- New multi-input dc-dc converters with high efficiency.
- High power tandem inverters for load management.
- Hardware and software package for power management, power flow control, individual converter control, and MPPT and other control strategies.
- Experimental microgrid system with integrated photovoltaic, wind and hydro generation.
- Technical papers will be published in top international journals and conference proceedings.



Applicability and transferability of the results

All the research results are the property of the project coordinator and its partners.

Financed through/by

Joint Applied Research Projects - Partnership in S&T priority domains financed by the Executive Agency for Higher Education, Research, Development and Innovation Funding (UEFISCDI).

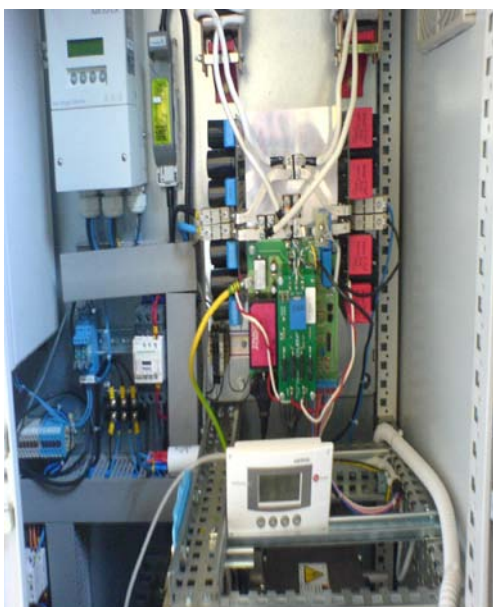

Research centre

Research Centre for Automatic Systems Engineering.

Research team

Octavian Prostean
Nicolae Muntean
Nicolae Budisan
Ioan Filip
Mircea Barglazan
Stefan Kilyeni
Ilarie Bordeasu
Teodor Milos
Cristian Vasar
Iosif Szeidert-Subert
Lucian Tutelea
Cristian Lascu
Sorin Deaconu
Gabriela Prostean
Dan Ungureanu
Andreea Robu
Adrian Bej
Radu Boraci
Octavian Cornea
Ovidiu Tirian
Rodica Badarau

Contact information

Prof. Octavian PROSTEAN, PhD
Department of Automation and Applied Informatics
Address: Bv. Vasile Pârvan, No. 2, RO300223, Timisoara
Phone: (+40) 256 403 225
Fax: (+40) 256 403 214
E-mail: octavian.prostean@upt.ro

EXPERIMENTAL MODEL FOR AN AUTOMATIC CAPACITIVE COMPENSATOR DESIGNED FOR IMPROVING THE POWER FACTOR AND FOR LOAD BALANCING IN LOW-VOLTAGE ELECTRICITY DISTRIBUTION NETWORKS - CAEREDJT

Goal of the project

The project is intended to finance industrial research activities, needed to put in practice under the form of an experimental model of research findings of a group of academics from UPT, concerning the network load balancing electric phase through cross unbalanced capacitive compensation. In electrical networks, inductive load variation implies variation of the capacitive compensation, thus the need for building an unbalanced capacitive automatic compensator, to track the load variation

Short description of the project

The automatically unbalanced capacitive compensator proposed by this project is an innovative product, so achieving a functional experimental model involves overcoming a number of scientific and technical challenges, the most important being: control and single-phase switching of the capacitor batteries steps, the construction algorithm and implementation of a programming language for PLC process control, process optimization for automatic compensation.

Project implemented by

- Politehnica University of Timisoara – Lead partner
- S.C. ICPE S.A. Bucharest – Project partner

Implementation period

01.07.2014 - 31.12.2016

Main activities

1. Conducting studies and analysis on the alternative constructive solutions and developing the technical documentation for the construction of the experimental model.
2. Manufacturing of the experimental model and the analysis, control and monitoring systems.
3. Testing the model and proving its functionality and its utility
4. Dissemination of results and protect the intellectual property rights.

Financed through/by

Executive Unit for Financing Higher Education, Research, Development and Innovation - UEFISCDI

Applicability and transferability of the results

The results of the project are useful for unbalanced electrical loads supplied at low voltage level, and also for the Distribution system operator (DSO).

Results

- The main outcome of the project will be a functional experimental model and its documentation of implementation for a capacitive compensator designed to improve power factor and load balancing in networks of low voltage power distribution.
- It will underpin the design and construction in a later stage, of a prototype of a capacitive automatically balance high power compensator (tens of kVA) for increasing network performance of low-voltage power distribution and utilization facilities connected to it, by reducing reactive power flow and load balancing.
- The results of the research will be disseminated in scientific papers in professional journals or communication conferences.
- New technical solutions brought by this automatic capacitive compensator, as regard to the structure, order, sizing, automatic control algorithm, will be the subject of intellectual property protection activities.

Research Centre

Analysis and Optimization of the Electrical Power Systems Regimes

Research team

Assoc.Prof. Adrian Pană, PhD
 Prof. Radu - Emil Precup, PhD
 Prof. Ștefan Preitl, PhD
 As. Florin Molnar-Matei, PhD
 As. Alexandru Băloi, PhD
 Lecturer Ilie Mihai Tăcucean, PhD
 Lecturer Mircea-Bogdan Rădac, PhD
 As.Claudia-Adina Bojan-Dragoș, PhD
 Alexandra Lulia Stînean, PhD
 Eng. Andrei Plettinger

Contact information

Assoc. Prof. Adrian PANĂ, PhD
 Department of Power Engineering
 Address: Bv. Vasile Pârvan, No. 2, RO300223, Timisoara
 Phone: (+40) 256 403420
 E-mail: adrian.pana@upt.ro
 Web: <https://sites.google.com/site/caeredjt/>

IONOSPHERIC PROPAGATION PREDICTIONS AND WIDEBAND COMMUNICATIONS USING HF SDR SENSORS FOR INFORMATIONAL SUPPORT IN EMERGENCY SITUATIONS IN ROMANIA

Goal of the project

The project aims to implement software and hardware solutions that integrate ionospheric sounding algorithms in a network of SDR (Software Defined Radio) sensors in order to develop and validate a HF (High Frequency) ionospheric prediction model for the territory of Romania.

Short description of the project

The project targets a systemic approach of the communication network through the implementation, development and integration of recent technological solutions from the perspective of providing information support for the management of interventions in disaster areas where communication infrastructure does not exist or is damaged. Project results can be applied not only in the rapid resolution of remote communications in emergency situations, but also can be extended to other applications in the HF communications range, such as encrypted data communication links for the government or the military.

Project implemented by:

- Land Forces Academy "Nicolae Bălcescu", Sibiu - Coordinator
- Interactive Systems & Business Consulting, Bucharest - Partner
- Politehnica University of Timișoara - Partner
- Technical University of Cluj-Napoca - Partner

Implementation period

21.11.2014 - 30.06.2016

Main activities

- Building a SDR sensor network for ionospheric sounding
- Elaboration of an application for HF propagation predictions in Romania.
- Development of broadband HF communications by the implementation of adaptive systems

Results

- an ionospheric model which is specific for Eastern Europe;
- algorithms for the automatic identification and classification of waveforms in order to increase the transfer rate and to implement techniques for dynamically accessing the HF resources;
- SDR solutions for local monitoring and collaborative spectrum sensing in the HF range;
- a HF radio network on the territory of Romania which allows high transfer rates in collaborative environments, by automatically adapting to specific conditions of ionospheric propagation at high angles of elevation.



Applicability and transferability of the results

- creating an integrated software application for HF propagation predictions adapted to the propagation particularities of our country
- developing localization algorithms used in OTH (Over-The-Horizon) radar systems
- establishing a tracking system in the HF range using SSL (Single Site Location) technology
- implementing the ionospheric measurement capability for HF radio stations with SDR architecture
- implementing algorithms for the adaptation of broadband waveforms to the ionospheric channel status
- developing a HF radio transceiver with cognitive capabilities
- implementing an integrated system for monitoring the ionosphere

Financed through/by

PN-II-PT-PCCA-2013-4

Research team

Prof. Aldo De Sabata, PhD
Assoc. prof. Septimiu Mischie, PhD
Assist. lect. Ciprian Dughir, PhD
Assist. lect. Cora Iftode, PhD
Assist. lect. Cornel Balint, PhD

Contact information

Prof. Aldo DE SABATA, PhD
Department of Measurement and Optical Electronics
Address: Bv. Vasile Pârvan, No. 2, RO300223, Timisoara
Phone: (+40) 256 403 370
E-mail: aldo.de-sabata@upt.ro

IMAGE FUSING TECHNIQUES (IMFUSING)

Goal of the project

The Line of Sight (LoS) of a satellite could be disrupted by obstacles, reducing the accuracy of the information provided to a Global Navigation Satellite System (GNSS) receiver. The first objective of the project is to eliminate or weight the signals coming from these satellites. To simplify the identification of satellites having a direct LoS with the GNSS receiver, this project proposes, as a supplementary sensor, to use a fish eye camera.

Short description of the project

To provide sufficient information to the GNSS receiver, at the image processing level, the algorithms conceived will include the calibration of the camera sensor, image segmentation techniques, and distance and angle measurements deduced from calibrated image analysis. The algorithms at user sensor level will use camera information to discard measurements, will estimate boundaries of accuracy, will build a Quality of Service (QoS) indicator on the computed position and will authenticate the position.

The algorithms at tracking loop level will use camera information to adjust the GNSS receiver correlator.

The segmentation of the image provided by the fish eye camera permits to identify the satellites that are not on the LoS of the GNSS receiver.

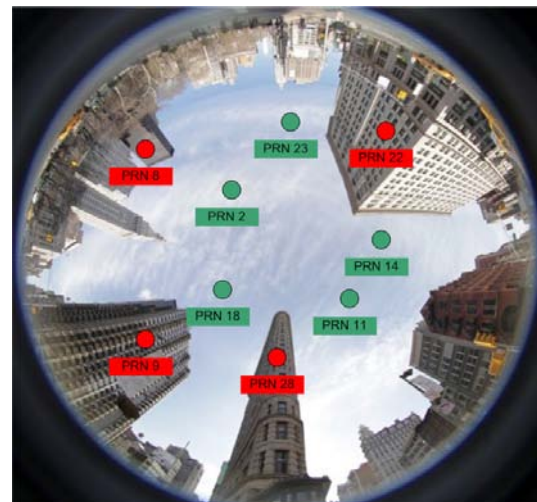

Original image. The satellites were marked at Thales-Alenia.

Project implemented by

- UPT as contractor
- Thales-Alenia Toulouse France as subcontractor

Implementation period

October 1 2014 – March 30 2017

Main activities

Phase I 01/10/2014–31/08/2015: State of the art analysis (already validated),

Phase II September 1 2015 – March 31 2017

- 01/09/2015–30/11/2015: Core technical development
- 01/12/2015–31/01/2016: Test campaign
- 01/12/2015–31/05/2016: Performance analysis
- 01/06/2016–30/09/2016: Dissemination and exploitation.



Segmentation result (the non sky region is colored in black) obtained applying an original segmentation method developed in our research team

Results

Deliverables:

- Report on the State of the art in Image-GNSS fusion, Preliminary Design Review Report, Test Review Board Report, MATLAB codes for developed algorithms.

Dissemination:

- Scientific paper in a scientific journal, Technical Note on synthesis of the study.

A first dissemination result:

- Naforniță C., David C., Isar A., Preliminary results on sky segmentation, Proceedings of 2015 International Symposium Signals Circuits and Systems, 9-10 July 2015, Iasi, Romania, pp. 1-4, 10.1109/ISSCS.2015.7203933, Print ISBN: 978-1-4673-7487-3

Applicability and transferability of the results

The subject is evaluated today at technology maturity level 1 (Scientific Research), and it is aimed to conclude the project at technology readiness level (TRL) 3 (Laboratory Experiments).

Financed through/by

- European Space Agency (ESA), contract number 10031/02.08.2013
 - UPT: 128.234 EURO,
 - Thales Alenia: 70.000 EURO

Research centre

Research Centre for Intelligent Signal Processing (ISPRC)

Research team

Prof. Miranda Naforniță, PhD
Assoc. Prof. Corina Naforniță, PhD
Prof. Andrei Câmpeanu, PhD
Prof. Ioan Naforniță, PhD,
Prof. Marius Oteșteanu, PhD
Prof. Vasile Gui, PhD,
Prof. Alexandru Isar PhD
Assist. Prof. Ciprian David, PhD

Contact information

Prof. Alexandru ISAR, PhD
Department of Communications
Address: Bd. Vasile Pârvan, No. 1, RO300223, Timisoara
Phone/Fax.: (+40) 256 403 307
E-mail: alexandru.isar@upt.ro
Web: <http://www.tc.etc.upt.ro/isprc/>

SY4SCI SYNERGY STUDY: OCEAN VIRTUAL LABORATORY

Goal of the project

The project will allow oceanography experts to discover the existence and then to handle jointly, in a convenient, flexible and intuitive way, the various co-located Earth Observed (EO) datasets and related model/in-situ datasets over dedicated regions of interest with a different multi facet point of view. The developed tools shall foster the emergence and prototype of new methods and products making use of the complementarity between sensors to study ocean related processes. The tool shall also provide the best possible visibility on the upcoming Sentinel1/2/3 data takes to help plan and coordinate with field campaign. The Ocean Virtual Laboratory (OVL) is filling the gap between Space agencies data portals that distributes specific EO data and analysis software dataset.

Short description of the project

The project aims to implement new software putting together two types of tools: a mathematical programming environment (as Matlab) and a geographical programming environment (as Google Earth). The raw data, as for example: Synthetic Aperture Radar (SAR) images, "temperature" images, "salinity" images, "altimetry" images; will be provided by satellites recently launched by the European Space Agency (ESA). The new software will have a multi-layer structure, each type of raw data representing a layer. The aim of new software is to exploit the information furnished by each layer and the difference of information obtained from different layers by hybridization (fusion), to characterize the phenomena at the ocean's surface (as the ocean currents for example). The tasks of the project are the following.

- Undertake an extensive scientific review to refine the project requirements and produce a consolidated Reference Baseline document.
- Implementation the SY-4Sci OVL novel synergy algorithms and the OVL platform, perform validation of new synergy products and access Sentinel1 and Sentinel3 products suitability for synergy studies.
- Write recommendation for further scientific research exploiting the synergy between ocean satellite sensors with a special focus on Sentinel1 and Sentinel3.
- Perform cross-cutting management and promotion of the SY-4Sci OVL project and open tools.

Implementation period

24 October 24 2014 – 24 October 2016.

Project implemented by

- OceanDataLab, Brest, France - Coordinator
- Institut Francais de Recherche pour l'Exploitation de la MER (IFREMER), Brest, France - Partner
- Nansen Environmental and Remote Sensing Center (NERSC), Bergen, Norway - Partner
- Politehnica University of Timisoara (UPT), Romania - Partner
- Institute of Oceanology of the Polish Academy of Sciences (IO PAN), Sopot, Poland and Plymouth Marine Laboratory (PML), Plymouth, UK - Partner

Main activities

- Review of existing synergy methods and consolidation of requirements,
- Define new methods and algorithm to be developed,
- Selection and preparation of EO products database,
- Specification and implementation of the prototype platform and processing modules,
- Specification and implementation of the prototype synergy processing modules,
- Validation of the developed tools and products,
- Recommendations for further scientific research.

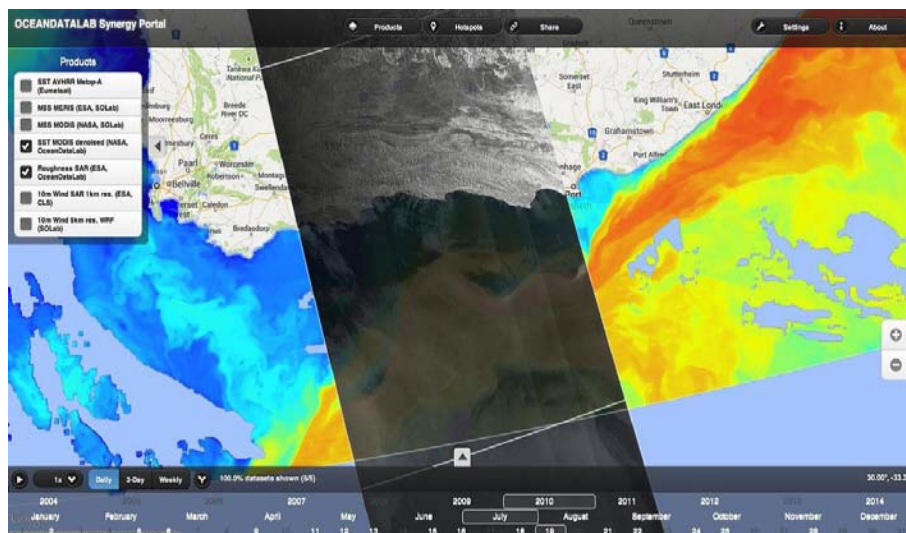

Results

- Deliverables
 - Requirements Baseline,
 - Algorithm Theoretical Basis document,
 - Product Specification document,
 - Product Validation Report,
 - Software User Manual.
- Dissemination
 - Publications,
 - Presentations

Applicability and transferability of the results

The subject is evaluated today at technology maturity level 1 (Scientific Research), and it is aimed to conclude the project at technology readiness level (TRL) 3 (Laboratory Experiments).

Financed through/by

- European Space Agency (ESA), ESRIN/Contract N° 4000112389/14/I-NB – consortium 250000 EURO,
- UPT: 24713 EURO.

Research centre

Research Centre for Intelligent Signal Processing (ISPRC)

Research team

Prof. Alexandru Isar, PhD
Assoc. Prof. Corina Nafornită, PhD

Contact information

Prof. Alexandru ISAR, PhD
Department of Communications
Address: Bd. Vasile Pârvan, No. 1, RO300223, Timisoara
Phone/Fax.: (+40) 256 403 307
E-mail: alexandru.isar@upt.ro
Web: <http://www.tc.etc.upt.ro/isprc/>

INTEGRATED PLATFORM OF RESEARCH AND DEVELOPMENT FOR THE BEHAVIOUR OF STRUCTURES UNDER EXTREME ACTION

Goal of the project

The framework goal of the project is the development of the research capacity of the departments within the Faculty of Civil Engineering from the Politehnica University of Timisoara, through the increase of the performances and the capacity of laboratories, and by integrating them into a multidisciplinary platform that should cover theme directions regarding the behaviour of structures subjected to extreme action: natural hazard – earthquakes and effects of climate changes, respectively human actions – explosions, fire, errors of construction and operation, etc

Project implemented by

The Politehnica University of Timisoara
Faculty of Civil Engineering

Implementation period

02.09.2013–30.09.2016

Main activities

The Research platform integrates the four departments within the Faculty of Civil Engineering from the Politehnica University of Timisoara, namely: Department of Steel Structures and Structural Mechanics, Department of Overland Communication Ways, Foundations and Cadastral Survey, Civil Engineering and Equipments, and Hydrotechnical Engineering. The projects aims at updating laboratories by adding equipments / stands / systems, on one hand, and at achieving new laboratories, by the acquisition of equipments / stands / systems, in view to achieving the goals of the project.

The following laboratories are updated, at the Department of Steel Structures and Structural Mechanics:

- Laboratory for the study of materials;
- Laboratory for the testing of structures and structural elements under static and dynamic actions, under ambient temperature and under low / high temperatures;
- Laboratory for advanced numerical analysis of structures

The following laboratories are updated, at the Department of Overland Communication Ways, Foundations and Cadastral Survey:

- Laboratory of geomatics;
- Laboratory for the testing and assessment of the quality of materials for road covering;
- Laboratory for the testing and assessment of physical and mechanical parameters of the foundation terrain;
- Laboratory for the macroscopic modelling of the road traffic and for the assessment of the environmental impact.

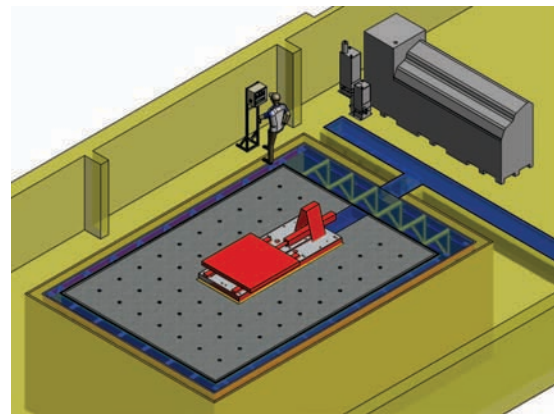

The following laboratories are updated, at the Department of Civil Engineering and Equipments:

- Laboratory for the testing and assessment of physical and mechanical properties and of the behaviour of materials, components and structural elements, under the action of extreme climate;
- Laboratory for the advanced numerical analysis of structures made of masonry, concrete, composite materials or wood, under the action of climatic effects and in case of natural or induced hazard.

The following laboratories are updated at the Department of Hydrotechnical Engineering:

- Laboratory for the assessment and monitoring of the quality of the environmental elements (water, air, soil), under normal operation and under the effect of weather changes;
- Numerical laboratory for the modelling, assessment and the optimization of water resources exploitation, in natural or developed environment.

The four departments are connected at the level of the Faculty of Civil Engineering, by means of an HPC cluster with data storage system.



Applicability and transferability of the results

The development of the project is in line with the priority axis 2 of POS CCE (Competitiveness through research, technological development and innovation), particularly with the goals of the operation 2.2.1. (development of the existing RD infrastructure and creation of new RD infrastructures) through:

- The achievement of a multidisciplinary axis of research, that satisfies various RD requirements with direct impact on the economic environment, or coming from the economic environment;
- The improvement of the basis of knowledge within priority themes of the construction sector;
- The training of the human resource, in particular of doctoral students, post-doctoral students and young teaching staff;
- The increase of the participation to the RD circuit, within large cooperation and projects, nationwide and worldwide;
- Technological transfer activities, including the support and promotion of innovative solutions regarding the economic environment

Financed through/by

The total value of the project is 21.000.000 lei, out of which 21.000.000 lei is non-refundable financial assistance.

The project is co-financed through the European Regional Development Fund, based on the financial agreement signed with the Ministry of National Education, as Intermediary Institution, on behalf of the Ministry of European Funds, as Management Authority for the Sectoral Operational Programme „Increase of Economic Competitiveness”, co-financed by the European Regional Development Fund Axis 2, Operation 2.2.1.

Research Center

The Research Centre for Mechanics of Materials and Structural Safety – CEMSIG, Politehnica University of Timisoara.

Research team

Acad. Prof. Dan Dubină, PhD
Assoc. Prof. Aurel Stratan, PhD

Contact information

Acad. Prof. Dan DUBINĂ, PhD
Member of Romanian Academy
Department of Steel Structures and Structural Mechanics
Address: Str. Ioan Cărea, No. 1, RO300224, Timisoara
Phone: (+40) 256 403 920
Fax: (+40) 256 403 917
E-mail: dan.dubina@upt.ro

EUROPEAN PRE-QUALIFIED STEEL JOINTS (EQUALJOINTS)

Goal of the project:

The goal of the project is to introduce in the European practice a qualification procedure for the design of moment resisting connection in seismic resistant steel frames, in compliance with EC8 requirements.

Particular objectives of the project are to qualify a set of standard all-steel beam-to-column joints, develop pre-qualification charts and design tools that can be easily used by designers. The project is also intended as a pre-normative research aimed at proposing relevant design criteria to be included in the next version of EC8. Besides it would contribute to the advancement of knowledge in the field of seismic behavior of steel moment resisting joints usually adopted in moment resisting frames (MR), in un-braced bays of dual moment-resisting/concentrically braced frames (MR+CB) and in moment-resisting/eccentrically-braced frames (MR+EB).

Short description of the project:

The project is the first attempt in Europe to produce qualification tools for seismic-resistant joints. Novel design methodologies and details for beam-to-column connections that are reliable, feasible and economical, solving also the open issue of design by testing required by EC8 for partial strength/stiffness connections will be provided. The cyclic behavior of beam-to-column joints has a crucial role on the overall seismic response of both MR and dual frames. Recent studies highlighted the influence of joint rotation capacity on the seismic response of mid-rise MR frames designed according to EC8.

The innovative content of the project is represented by:

- Experimental investigations on 96 beam-to-column joint specimens covering: three typical European typologies and one US dog-bone joint typology made of heavy cross sections;
- Evaluation of the influence of different parameters (e.g. axial force, loading protocol and member sizes) on the joint performance;
- Development of codified pre-qualification charts of typical beam-to-column joints used in EU practice.
- In Europe these tools do not exist in design codes. Hence, this project was intended as pre-normative research aiming to propose design guidelines for the future version of EC8.

Project implemented by

- University of Naples "Federico II", Department of Structures for Engineering and Architecture.
- Politehnica University of Timișoara, Department of Steel Structures and Structural Mechanics

Implementation period:

01.07.2013 – 31.06.2016

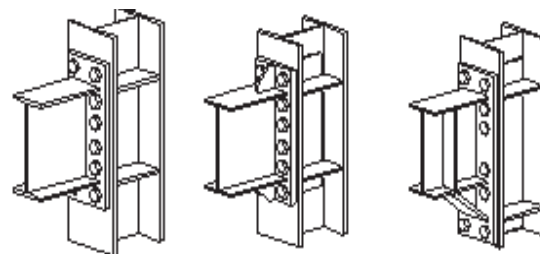

Main activities:

Regarding the aim and objectives of the project, a design procedure for joints was established according to the provisions of EC3, EC8 and AISC 358. Extensive pre-test finite element (FE) numerical simulations were carried out with the purpose of evaluating the designed beam-to-column joint assemblies, and the influence of several parameters. The pre-test numerical simulation comprised the calibration of a T-stub model, including the material model for bolts. Based on the outcomes of the FE simulations, the design procedure of the joints was adjusted considering the actual position of the compression center and the active bolt rows.

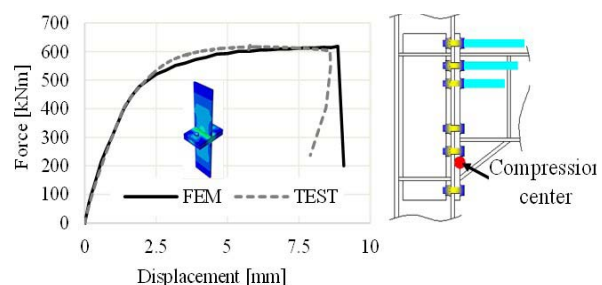

The cyclic response of a joint was evaluated as well. Future activities will be devoted to the experimental investigation of material samples, and 24 large-scale joint assemblies.



Particular results are represented by the selection of members (beams & columns) from the analyzed frames, and the development of a design procedure for bolted beam-to-column haunched connections. The pre-test numerical simulations lead to some adjustments of the joint design procedure and joint configurations. As a result, the joint configurations were established and the experimental test set-up was designed. Finally, the shop drawings for joint specimen and test set-up were completed.

Results:

- Particular results are represented by the development of a design procedure for bolted beam-to-column haunched connections. The pre-test numerical simulations lead to several adjustments of the joint design procedure and joint configurations. As a result, the joint configurations were established. The parametric study allowed investigating the influence of: member size, haunch geometry, web panel strength, and cyclic loading.

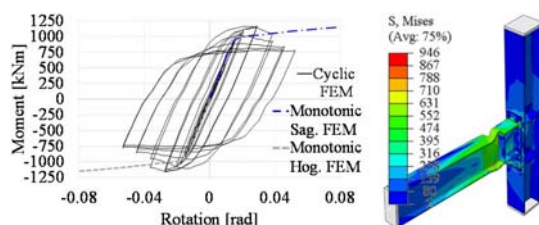

Applicability and transferability of the results:

- The project provides easy-to-use design tools for engineers and promotes saving cost solutions. Particular outcomes of the project are intended to be introduced within the new version of European seismic design code EN 1998-1.

- In addition, the outcomes of the project will be largely beneficial for the EU industry. Because the US joints examined within EQUALJOINTS will be made of heavy sections, which are produced only in Europe, this will be an important opportunity to get on the US Market, consolidating the gain of EU economy and having beneficial impact to exportation of EU products.
- The impact and transferability of the project is by no means restricted to the selected joint configurations and this project will open the door for other joints to be included in future updates of the guidelines.

Financed through/by

Research Fund for Coal and Steel, grant agreement RFSR-CT-2013 – 00021.

Fields of interest:

Seismic resistant structures for multi-storey building frames.

Research Center

The Research Centre for Mechanics of Materials and Structural Safety – CEMSIG, Politehnica University of Timisoara.

Research team

- University of Naples “Federico II” (UNINA) – Coordinator
- Imperial College (IC)
- University of Coimbra (UC)
- University of Liege (ULg)
- Politehnica University of Timisoara (UPT)
- European Convention for Constructional Steelwork (ECCS)
- ArcelorMittal Belval & Differdange S.A. (AM)
- CORDIOLI & C

Contact information

Acad. Prof. Dan DUBINĂ, PhD
 Member of Romanian Academy
 Department of Steel Structures and Structural Mechanics
 Address: Str. Ioan Cărea, No. 1, RO300224, Timisoara
 Phone: (+40) 256 403 920
 Fax: (+40) 256 403 917
 E-mail: dan.dubina@upt.ro

SEISMIC PROTECTION OF ENGINEERING STRUCTURES THROUGH DISSIPATIVE BRACES OF NANO-MICRO MAGNETO-RHEOLOGICAL FLUID DAMPERS – SEMNAL-MRD

Goal of the project:

The goal of the project is to develop a seismic protection system, which uses magneto-rheological fluid (MRF) dampers, acting as semi-active structural control system. Particular objectives are:

- To develop nano-micro MRF compatible with application in seismic MR dampers;
- To design and built a 10tf capacity MR damper;
- To provide type tests, based on EN 15129-2009: Anti-seismic devices, aimed to validate, calibrate and model the damper;
- To design, execute and test a brace-damper assembly in order to validate the integration of damper and brace, including connections;
- To propose structural application schemes for implementation in practice of semi-active control brace-MRD systems.

Short description of the project:

There are three strategies for the seismic protection of structures: (i) reduce seismic demands, (ii) enhance structural damping, and (iii) use active or semi-active structural control. The current project involves the third approach focusing on semi-active systems. Semi-active devices have properties that can be adjusted in real time but cannot inject energy into the controlled system. Many of them can operate on battery power alone, proving advantageous during seismic events when the main power source to the structure may fail. The most promising devices suitable for implementation into a semi-active control appear to be magneto-rheological (MR) dampers, which succeed in overcoming many of the expenses and technical difficulties associated with other types of semi-active devices.

Response characteristics of MR devices can be changed by varying the magnetic field through different current inputs. In addition to its small power requirement, the MR damper can transfer large forces at low velocities. Currently there are MR dampers with capacities up to 200 kN and research results proved the possibility to obtain capacities up to 400-500 kN.

Project implemented by

- The Research Centre for Mechanics of Materials and Structural Safety – CEMSIG, Politehnica University of Timișoara.

Implementation period:

01.07.2014 – 30.06.2016

Main activities:

The activities of the project are divided in three stages (I/2014, II/2015, III/2016), of which the first was completed. The second stage is in progress, covering several main activities: (i) preparation and characterization of nano-micro composite magneto-rheological (MR) fluid for seismic semi-active dampers, (ii) testing of a MR damper model containing the MR fluid, (iii) development of the technical solution for the 10t MR damper.

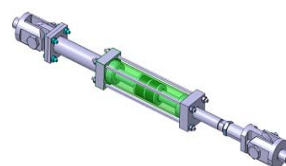
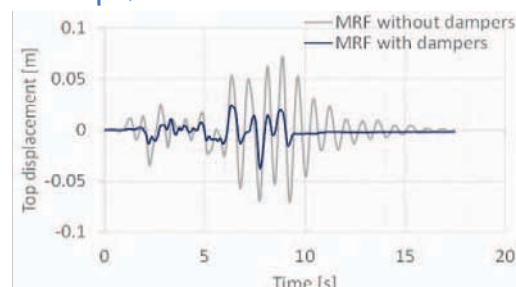
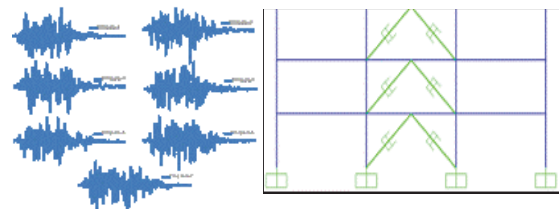

Further, the MR damper will be fabricated and tested under different loading conditions (triangular, sinusoidal, random excitations). In addition, numerical hysteretic models will be calibrated based on the tested MR damper enabling the modeling of structural response. Since the dampers in structural systems will be coupled with braces, both single damper and brace-damper assembly tests will be performed. With a numerically simulated control unit, structural systems equipped with brace-damper assemblies will be numerically tested in order to observe and characterize their behavior.

Results:

The results of the second stage comprise nano-micro composite MR fluid recipes for seismic semi-active dampers, and the technical solution for the MR damper.

Besides, the main outcomes of the project will be:

- The prototype of the MR damper;
- Validation tests of brace-damper systems;
- Numerical evaluation of effectiveness of MR dampers in reducing seismic effects in structural applications.
- Design and numerical testing of the control algorithm on single degree of freedom systems

Applicability and transferability of the results:

- The target of the project is the pilot solution for the MR damper, which will represent the basis for the mass production by the industrial partners.
- Considering the seismicity of Romanian territory and the effectiveness of the dissipative devices targeted in the project (once under fabrication, the implementation in new and existing structures would be quite easy), the national market potential is very large. On the other hand, this market can comprise all the Balkan's area, including Turkey and Greece, with development potential towards neighboring Asian Countries.

Financed through/by

The project is supported by a grant of the Romanian National Authority for Scientific Research, CNDI-UEFISCDI, project Nr. 77/2014 (PN-II-PT-PCCA-2013-4-1656).

Fields of interest:

Seismic resistant structures for multi-storey building frames

Research Center

The Research Centre for Mechanics of Materials and Structural Safety – CEMSIG, Politehnica University of Timisoara.

Research team

- Politehnica University of Timișoara
 - CMMC – Department of Steel Structures and Structural Mechanics
 - CNISFC – Research Centre for Complex Fluid Systems Engineering
- S.C. ROSEAL S.A.
- IMS-AR - Institute of Solid Mechanics of the Romanian Academy
- AR-FT - Timișoara Branch of the Romanian Academy
- S.C. TITAN S.A.

Based on the above listed research team, the interdisciplinary character should be emphasized, as well as the cooperation between the Civil Engineering branch, the Mechanics branch, the Romanian Academy, and the industrial partners.

There are no secrets to success. It is the result of preparation, hard work, and learning from failure.

Colin Powell

Contact information

Acad. Prof. Dan DUBINĂ, PhD
Member of Romanian Academy
Department of Steel Structures and Structural Mechanics
Address: Str. Ioan Curea, No. 1, RO300224, Timisoara
Phone: (+40) 256 403 920
Fax: (+40) 256 403 917
E-mail: dan.dubina@upt.ro

STEEL-EARTH - STEEL-BASED APPLICATIONS IN EARTHQUAKE-PRONE AREAS

Goal of the project:

- Steel-earth project aim to develop practical tools and documents for engineers, standardization bodies and construction companies in order to exploit at best the results obtained in previous RFCS research projects dealing with different open problems of seismic design, i.e. OPUS, STEELRETRO and PRECASTEEL.

Short description of the project:

Steel-earth disseminate the results obtained in OPUS (Optimizing the seismic performance of steel and steel-concrete structures by standardizing material quality control), STEELRETRO (Steel solutions for seismic retrofit and upgrade of existing constructions) and PRECASTEEL (Prefabricated steel structures for low-rise buildings in seismic areas).

Project implemented by

- The Research Centre for Mechanics of Materials and Structural Safety – CEMSIG, Politehnica University of Timișoara.

Implementation period:

Main activities:

- Harmonization of design and production standards (i.e. Eurocodes and Euronorms on steel products like EN 10025, EN 210210 and EN 10219) in order to optimize steel performance for structural ductile design overcoming the actual contradictions of available standards.
- Seismic rehabilitation of existing masonry and reinforced concrete buildings by means of steel-based solutions including innovative solutions based on enhanced dissipative systems.
- Seismic design of steel and steel-concrete industrial and commercial buildings for which suitable pre-designed solutions were individuated, including innovative solutions using enhanced dissipative systems or using alternative bracing system as precast double-slab wall, and collected in a properly developed software available online.

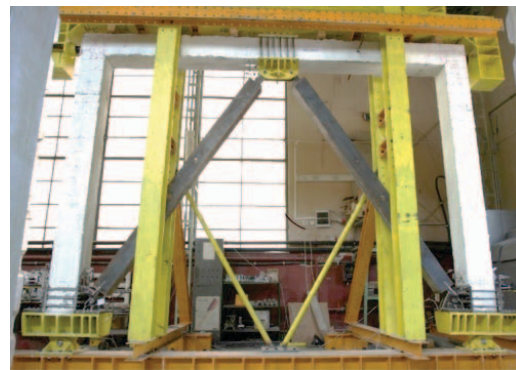

Results:

- Technical sheets and working examples describing the related prefabricated steel or steel-concrete composite solutions for realizing single-storey industrial and low-rise commercial buildings in seismic prone areas and concerning the rehabilitation of existing buildings have been prepared. Pre-normative documents related to harmonization of design and production standards and some contributions for Eurocodes are available.
- In order to make available aforementioned results to engineers and construction companies and to national and European standardization bodies of relevant commissions and working groups of CEN/TC250, ECCS and CEN-ECISS, all documents will be disseminated all over Europe together with the software developed in PRECASTEEL project, translated in different European languages.

Applicability and transferability of the results:

- Two training courses, five conferences and several workshops in locations cover both high and medium seismicity areas (Italy, Finland, Slovenia, Spain, Germany, Belgium, Romania, Portugal and Greece) are organized in order to disseminate the results.
- Particular attention will be paid to the exploitation of innovative constructional solutions and design rules for the design of new industrial and commercial buildings and for the seismic retrofit of existing ones.

Financed through/by

Research Fund for Coal and Steel (RFCS) - total budget of "Steel-Earth" project: 1.045.186 € and budget of the Politehnica University of Timisoara: 35.314 €

Research Center

The Research Centre for Mechanics of Materials and Structural Safety – CEMSIG, Politehnica University of Timisoara.

Research team

The partnership is composed by industries, companies, research and academic institutions:

- University of Pisa
- RIVA Acciaio SpA
- University of Camerino
- Ferriere Nord S.p.A
- University of Rome
- University of Parma
- Coordinamento Sismico Regione Toscana
- Centro Europeo di Formazione e Ricerca in Ingegneria Sismica (Italy)
- Hasselt University
- European Convention for Constructional Steelwork (Belgium),
- University of Thessaly,
- Shelter S.A. (Greece)
- Rheinisch-Westfälische
- Technische Hochschule Aachen (Germany),
- INSAR- INSA deã
- Rennes (France),
- VTT - Technical Research Centre (Finland)
- Politechnic University of Timisoara (Romania).

Contact information

Acad. Prof. Dan DUBINĂ, PhD
Member of Romanian Academy
Department of Steel Structures and Structural Mechanics
Address: Str. Ioan Curea, No. 1, RO300224, Timisoara
Phone: (+40) 256 403 920
Fax: (+40) 256 403 917
E-mail: dan.dubina@upt.ro

IMPLEMENTATION INTO ROMANIAN SEISMIC RESISTANT DESIGN PRACTICE OF BUCKLING RESTRAINED BRACES (IMSER)

Goal of the project:

Goal of the project: The goal of the project is to create the background for quick implementation of the steel frames with buckling-restrained braces (BRB) into Romanian practice design.

Short description of the project:

The latest version of the Romanian seismic design provisions (P100-1/2013) have introduced, for the first time in Europe, design provisions for buckling restrained braced frames (BRBF). Buckling restrained braces have a great potential in the field of seismic design of structures due to their large ductility and symmetrical cyclic response, as compared with conventional braces.

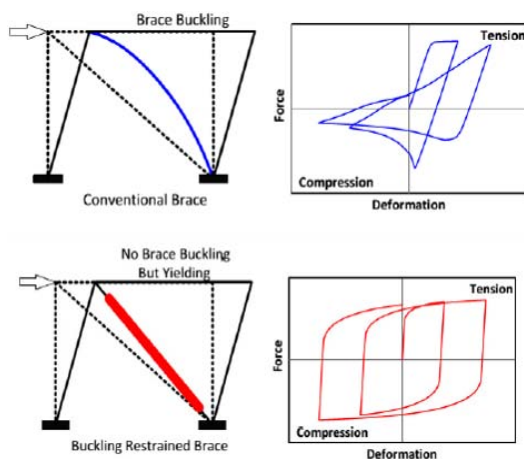

BRBF can be used both for new construction, as well as for strengthening of existing reinforced concrete, steel or masonry structures. BRB frames are able to provide two key properties of a seismic resistant structure: stiffness (for reducing interstorey drifts under moderate earthquakes) and ductility (for energy dissipation capacity under large earthquakes). BRBs were studied extensively worldwide over the past 30 years and have many practical applications especially in Japan and United States. Though researched in Europe as well, BRBs were applied in a very few applications here. The main reasons for lack of application into practice are believed to be the absence of design provisions in EN 1998-1, not enough acquaintance with the system by practicing structural engineers, need for experimental validation, and proprietary character of most BRB devices.

Project implemented by

- Project implemented by: CEMSIG - The Research Center for Mechanics of Materials and Structural Safety, Research and Technical Development unit of Politehnica University Timisoara, at the Faculty of Civil Engineering, Department of Steel Structures and Structural Mechanics.

Implementation period:

01.07.2014 – 30.06.2016

Main activities:

- Development of two different types of BRB prototypes: "conventional" (steel core / mortar / steel casing) and "dry" (without mortar), followed by a prequalification testing program on a set of BRBs of different capacity. This will provide an initial database on prequalified BRBs, rendering project-specific experimental programs unnecessary, at least for most common design situations;
- Transfer of the "know-how" on design and production of two types of BRBs to the industrial partner, who will be able to set up quantity production of these devices;
- Development of design guidelines for buckling restrained braces (at the device level). It will allow production of generic BRBs by local producers at more competitive prices than imported ones. "Dry" (or "steel-only") BRBs are believed to be especially suited for this purpose, as they can be easily adopted by steel fabricators;
- Development of design guidelines and design examples for steel BRB frames (at system level).
- Dissemination of the project outcomes to practising engineers, through presentations in annual conferences of the Association of Structural Engineers (AIKPS) and through two workshops organised in Bucharest and Timisoara.

Results:

The following results were achieved up to the present date:

- Design of prototype structures for two building typologies (low-rise and mid-rise), which are located in two different seismic zones (Bucharest, $TC = 1.6$ s and Timisoara, $TC = 0.7$ s). There were designed 16 structures: MRFs, BRBFs, D-BRBFs, and CBFs according to Eurocode 3, Eurocode 4 and P100-1 /2013. The low-rise structures were 3 storey-high ($H = 10.50$ m) and the plan layout was 3 spans of 7.5 m by 5 bays of 7.5 m. The mid-rise structures were 6 storey-high ($H = 21.00$ m) and had the same plan layout. BRBs were disposed in chevron configuration. MRF structure will be used for comparative assessment of analysed structures from the economic and technical point of views
- Selection of typical capacities of BRBs. Two typical BRB capacities were selected (300 kN, respectively 700 kN), which together can cover a range of demands in BRBs ranging from 136 kN to 839 kN.
- Synthesis of existing information on performance and design of BRBs. A comprehensive literature review was performed identifying options for component materials, technology and design methods. These will serve as a starting point for developing a set of “dry” and “conventional” BRBs to be prequalified through an extensive numerical and experimental program.
- Seismic performance evaluation of structures was accomplished using nonlinear static analyses for three seismic performance levels: serviceability (SLS), ultimate (ULS) and collapse prevention (CP), corresponding to seismic hazard levels characterised by 42, 224 and 975 years return period.

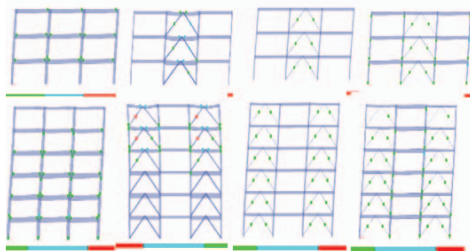

Applicability and transferability of the results:

- A Design Guide for both “dry” and “conventional” BRBs for manufacturers, as well as a Design Guide (including examples) for steel BRB frames for practising engineers will be produced within the project. Moreover, a set of BRBs will be prequalified, eliminating the need of project-specific testing. The design guidelines and the prequalification will facilitate the use of BRBs in the Romanian design practice.

Financed through/by

The project is supported by a grant of the Romanian National Authority for Scientific Research, CNDI–UEFISCDI, project Nr. 99/2014 (PN-II-PT-PCCA-2013-4-2091).

Research Center

The Research Centre for Mechanics of Materials and Structural Safety – CEMSIG, Politehnica University of Timisoara.

Research team

- Politehnica University of Timisoara, (coordinator);
- SC Popp & Asociații SRL, Bucharest;
- SC HYDOMATIC SISTEM SRL, Timisoara.



Contact information

Assoc.prof. Aurel STRATAN, PhD.
Department of Steel Structures and Structural Mechanics
Adress: Str. Ioan Curea, No. 1, RO300224, Timisoara
Phone: (+40) 256 403 923
Fax: (+40) 256 403 917
E-mail: aurel.stratan@upt.ro
Web: <http://www.ct.upt.ro/centre/cemsig/imser.htm>

TEMPERATURE ASSESSMENT OF A VERTICAL STEEL MEMBER SUBJECTED TO LOCALISED FIRE PROJECT (LocaFi)

Goal of the project

The main goal of the project, ended in 2015, was to improve the existing knowledge on the effects of the localized fires in a building compartment. With the actual methodology included in the Eurocodes for the fire design of buildings, it is only possible to assess the temperature of a steel element in the vertical axis of the localised fire. It is impossible to assess the temperature or the flux received by a vertical member at a given distance of the fire source.

Short description of the project

The project is devoted to the development of an analytical model for the calculation of the temperatures in the vertical structural steel elements of a building, subjected to localised fires. The new method, developed by means of experimental and numerical research, will provide the fluxes received in any point of a building compartment subjected to a localised fire.

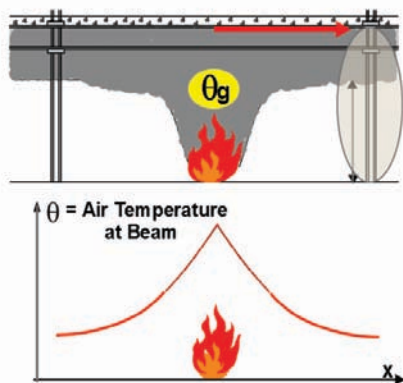

Project implemented by

- ArcelorMittal Luxembourg (coordinator)
- Centre Technique et Industriel de la Construction Métallique, France
- Politehnica University of Timisoara, Romania
- Universite de Liege, Belgium
- University of Ulster, Ireland

Implementation period

01.07.2012- 30.06.2015

Main activities

- Collection of the different national annexes and national parameters for the application of the Natural Fire Models in different European countries and implementation of these parameters in a Software
- Definition and realisation of laboratory tests assessing the effect of the real flame emissivity for element engulfed into the fire
- Definition and realisation of laboratory tests assessing the fluxes received by an element subjected to localised fire but not engulfed in the fire
- Development and validation using CFD models of simplified analytical model for the evaluation of the fluxes received by an element in any point of a compartment
- Implementation of the developed analytical model in a user-friendly tool
- Redaction of a design guide for the application of the new methodology including design examples

Results

The design procedures based on the analytical models developed within the project are proposed to be implemented in the Eurocodes.

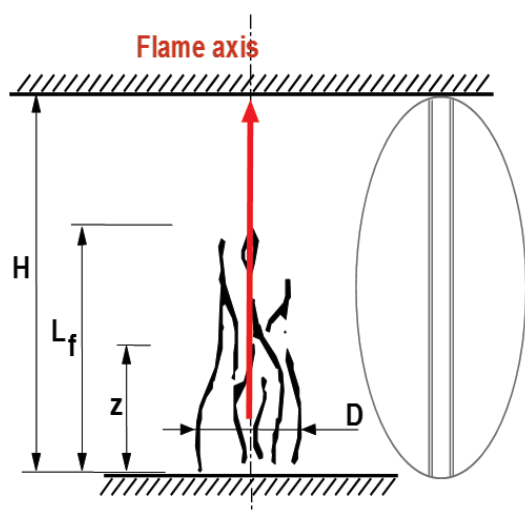

Applicability and transferability of the results

The analytical models developed within the project were introduced in a user friendly software and in an advanced calculation model for fire design, in order to offer a large utilization of the procedure for the construction market.

Research team

Assoc. Prof. Raul Zaharia, PhD
Prof. Acad. Dan Dubină, PhD
Lecturer Dan Pintea

Fields of interest

Design of buildings in fire situation.

Education is not the filling of a pail, but the lighting of a fire”
William Butler Yeats

Financed through/by

EUROPEAN COMMISSION DIRECTORATE-GENERAL FOR RESEARCH AND INNOVATION
Research Fund for Coal and Steel - RFCS

Research centre

Research Center for Mechanics of Materials and Structural Safety - CEMSIG

Contact information

Assoc. Prof. Raul ZAHARIA, PhD
Department of Steel Structures and Structural Mechanics
Address: Str. Ioan Curea, No. 1, RO300224. Timisoara
Phone: (+40) 256 403 922
E-mail: raul.zaharia@upt.ro

STRUCTURAL CONCEPTION AND COLLAPSE CONTROL PERFORMANCE BASED DESIGN OF MULTISTORY STRUCTURES UNDER ACCIDENTAL ACTIONS (CODEC)

Goal of the project

The main goal of the project is the development of a performance based robustness design methodology for mitigation of progressive collapse of multi-story frame buildings against extreme load events coming from both natural and man-made hazards.

Short description of the project

Safety and operability of steel buildings can be endangered by accidental actions. Today codes give general information only and lack much information that are required if robustness is envisaged. The project aims at evaluating those structural components and materials properties that can reduce the consequences, thus saving lives and reducing the costs in the aftermath of an extreme event. Different structural systems and details were tested experimentally under static and dynamic actions (blast), at room and elevated temperatures (fire), and the main response parameters were quantified. Afterwards, numerical models were validated, as a first step to perform extensive parametric studies. When all completed, these studies will allow the development of a collapse control design methodology for reducing the consequences associated with the extreme loading events .

Project implemented by

- Coordinator (CO) – Politehnica University of Timisoara
- Partner 1 (P1) - Technical University of Cluj-Napoca
- Partner 2 (P2) - URBAN-INCERC (Cluj Branch)
- Partner 3 (P3) - INSEMEX Petrosani
- Partner 4 (P4) - SC ACI SA Cluj-Napoca

Implementation period

July 2012 - June 2016



Fig. 1a. Joint specimen after the test

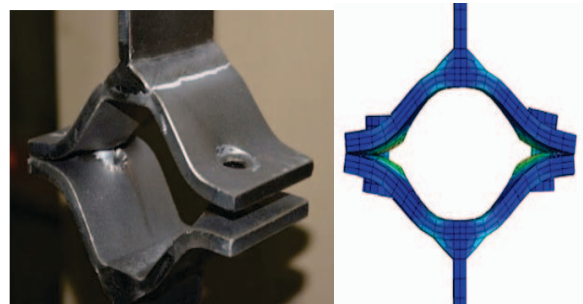

Fig. 2a. Experimental T-stub

Fig. 2b. Numerical simulation T-stub

Main activities

- Preliminary investigations (Review of existing methods, identification of research needs; Preliminary analysis and selection of case study structures)
- Design of experimental and numerical simulation programs
- Experimental program on materials, weld details and connection macro-components
- Experimental program on joints (column loss scenarios and blast conditions)
- Experimental program on sub-assemblies
- Validation of numerical models against experimental tests
- Numerical simulation program
- Design guidelines and recommendations

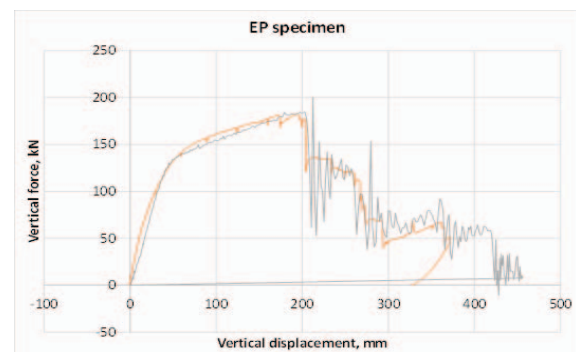

Fig. 1b. Experimental vs. numerical force-displacement curve

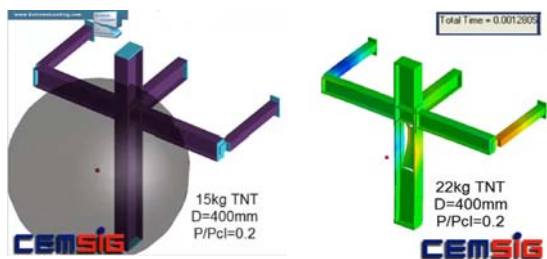

Fig. 3a (left) and 3B (right) Direct blast effect on steel assemblies

Results

- Experimental results (characteristic curves, failure modes, robustness) on T-stubs and weld detail tested in extreme conditions (loading rate, temperature)
- Experimental results on steel joints under column loss scenarios (characteristic curves, failure modes, robustness)
- Experimental results on steel and composite frame systems under column loss scenarios (characteristic curves, failure modes, robustness)
- Direct blast effects on steel elements and connections (influence of stand-off distances, charge size, charge characteristics).
- Numerical models validated against experimental tests.

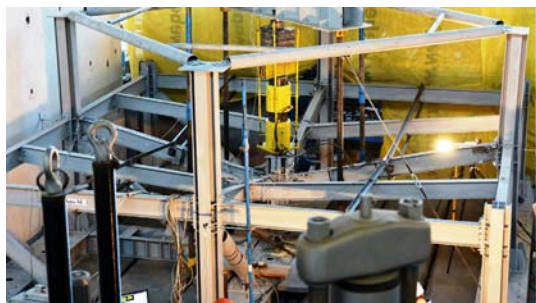

Fig. 4a. Experimental test on 3D steel frame system

Applicability and transferability of the results

- Construction and design practice, code and primer manuals drafting



Fig. 5. Experimental test on 3D composite frame system



Fig. 6. Composite slab system during construction

Financed through/by

the Executive Agency for Higher Education, Research, Development and Innovation Funding (UEFISCDI), Romania, under grant PN II PCCA 55/2012.

Research Centre

- The Research Center for Mechanics of Materials and Structural Safety – CEMSIG (www.ct.upt.ro/centre/cemsig/index.htm)

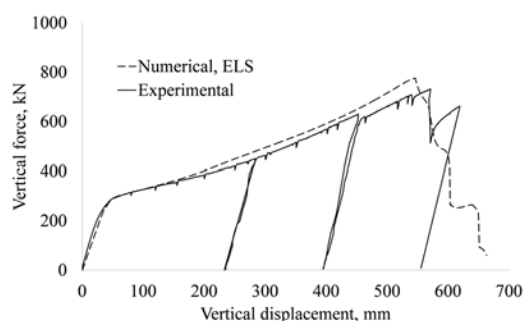

Fig. 4b. Experimental vs. numerical force displacement curve for 3D steel frame system

Research Team

Prof. Florea Dinu, PhD (Project coordinator)
 Prof. Dan Dubină, PhD
 Prof. Raul Zaharia, PhD
 Assoc. Prof. Adrian Ciutina, PhD
 Assist. prof. Ioan Both, PhD
 Assist. prof. Calin Neagu, PhD
 Ioan Mărginean, PhD Student

Contact information

Prof. Florea DINU
 Department of Steel Structures and Structural Mechanics
 Address: str. Ioan Curea, No. 1, RO300224, Timisoara
 Phone: (+40) 256 403 912
 Mobile: (+40) 722 460 349
 E-mail: florea.dinu@upt.ro
 Web: www.ct.upt.ro/centre/cemsig/codec.htm

NEARLY ZERO ENERGY BUILDING AND PASSIVE HOUSE – SUSTAINABLE SOLUTIONS FOR RESIDENTIAL BUILDINGS

Goal of the project

The idea of this project arose from the need to develop energy efficient solutions that reduce the energy consumption in the Romanian residential building sector. The main goal of the NEZEBUILD research project is related to the design and detailing of technical solutions in order to achieve the nearly zero energy building standard, resulting in the validation of such designs through extensive monitoring. Design, detailing and execution include the construction elements, finishes and installations system.

Short description of the project

The research project deals with a topic of great importance regarding the design and execution of energy efficient buildings in the Romanian climatic and economic conditions. A pilot project was developed consisting in a residential building composed of two detached houses. The two houses were designed and built so that one house will achieve the passive house (PH) standard and the other house the nearly zero energy building standard (NZEB). Building such types of houses implies the necessity to implement a monitoring system with a good quality - price balance, necessary in order to validate the theoretical design. The PH and NZEB are equipped with monitoring systems. Through the monitoring process of the two houses, the energy consumption is measured and thermal comfort parameters are kept under observation. The data registered by the monitoring system is uploaded to a web server making the data available on the internet. All project activities aim at developing a recommendation design guide regarding PH an NZEB based on experimental research.

Project implemented by

- Project Partnership comprising Politehnica University of Timisoara - CCI Department and Arhitim.

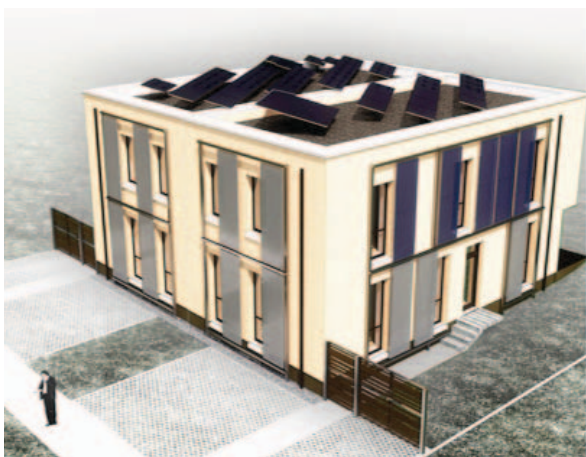

Fig. 1 General view of house

Implementation period

2012 – 2016

Main activities

- Design and detailing of NZEB system including procurement of materials, equipment and elaboration of energy performance certificate for NZEB.
- Design of the monitoring system and set-up of equipment and accessories for NZEB.
- Evaluation of monthly energy consumption for the two houses. Evaluation of main consumption, energy produced and consumed from renewable sources.
- Overall investment cost assessment and lifetime of the building. Analysis of the overall cost of the investment, cost benefit analysis damping coefficient for NZEB investment, optimized investment payback.
- Evaluation of elements with significant impact in terms of environmental protection.
- Lifecycle assessment using specialized software SimaPro - LCA with different scenarios Simapro program, materials recovery and waste management.
- Elaborating a comparative PH vs. NZEB study on energy efficiency.
- Dissemination of recommendations and general rules for implementing energy efficient residential houses in the Romanian temperate climate.

Results

The actual status of the project consist in the continuous processing and interpretation of the data obtained through the monitoring activity of the two houses. The passive house is monitored for more than three years and so far we have collected the registered data and established a strategy for processing. The amount of data is considerable taking in consideration that the measurements were taken at every minute. The monitoring process for NZEB started in 2014 but since the house is inhabited only from the beginning of 2015, relevant registered data is starting with 2015. Throughout the year, the results are published in scientific papers. The monitoring process of the two houses along with real time monitoring graphs can be viewed online at the address <http://www.sdac.ro/site/archives/category/monitoring>

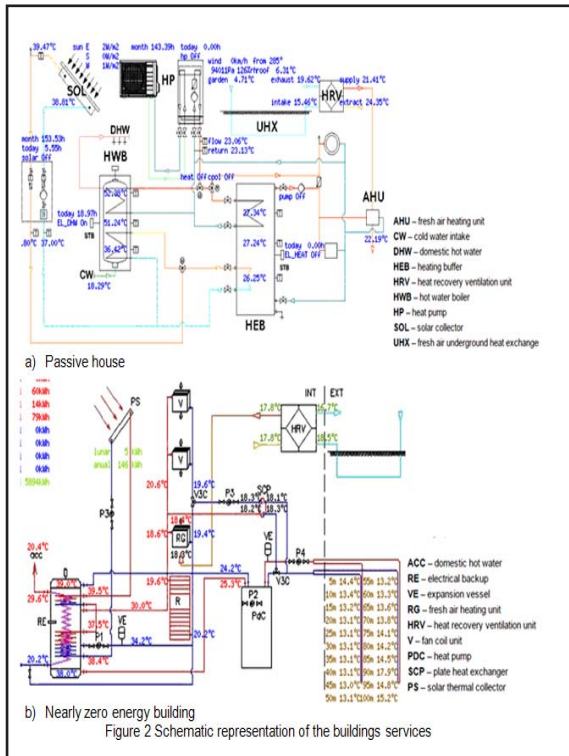

Applicability and transferability of the results

The topic of the project is closely related with the increasing concern of nowadays society on reducing the energy consumption in buildings. The targeted groups of the project are scientist, specialists in the energy efficiency field and stakeholders. The project deliverables will assure the transfer of knowledge, generating further „know-how“ for scientific community and for practicing specialists (civil and environmental engineers, electrical and energy engineers, architects, technicians).

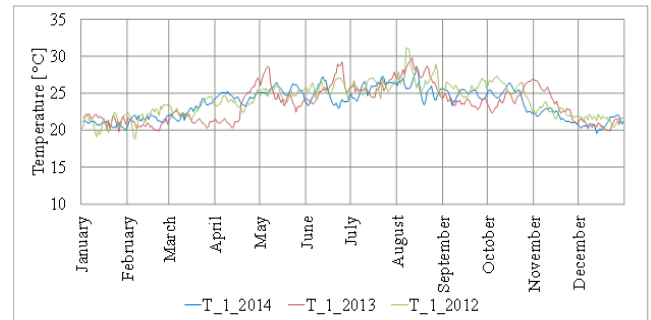
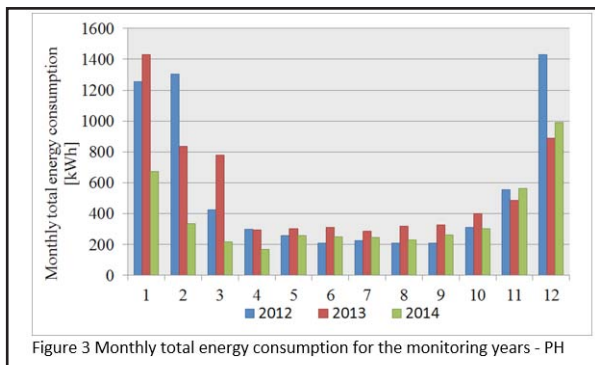

Financed through/by

UEFISCDI, project number PN-II-PT-PCCA-2011-3.2-1214-Contract 74/2012.

Research Centre

- Research Centre for Retrofitting of Constructions – RECO
- CCI Department

Research Team

Prof. Daniel Dan, PhD – Project Manager

UPT TEAM MEMBERS

Prof. Valeriu Stoian, PhD
 Assist. Lecturer Tamas Nagy-Gyorgy, PhD
 As. Sorin-Codrut Floruț, PhD
 As. Eng. Cosmin Daescu, PhD
 Eng. Simon Pescari, PhD student
 As. Calin Sebarchievici, PhD

ARHITIM TEAM MEMBERS

Arh. Dan Stoian, PhD student
 Eng. Cristina Tanasa, PhD student

Contact information

Prof. Daniel DAN, PhD
 Department of Civil Engineering and Building Services
 Address: Str. Traian Lalescu, No.2, RO300223, Timisoara
 Phone: (+40) 256 403 005
 E-mail: daniel.dan@upt.ro

NUTRITIONAL LABELING STUDY IN BLACK SEA REGION COUNTRIES - NUTRILAB

Goal of the project

- Bring together, review and analyze current research on consumer understanding of claims, and also labeling where this would inform our knowledge of consumer understanding of claims.
- Gather information on how consumer understanding of claims varies across different population groups, to gain insight into the understanding of the 'average consumer'.
- Draw conclusions from existing research to see whether there are areas where further information would be useful, and to inform the direction that any additional research conducted in future could take. A strong component in this framework will be the capacity building. It will explicitly aim to identify and integrate the different and overlapping conceptual understandings of scientists from the different disciplines carrying out joined research in this project.

Short description of the project

This multidisciplinary and comparative Joint Exchange programme will identify and examine how nutritional labeling in European countries and out of Europe can influence on health and welfare of population. Health professionals agree that the relationship between diet and health is important. Our eating habits can help or hurt our overall health and well-being. Good eating habits include being a smart shopper and selecting foods that reflect the Dietary Guidelines. The food label was designed to help people choose foods for a healthful diet. By using the food label, we can compare the nutrient content of similar foods, see how foods fit into our overall diets, and understand the relationship between certain nutrients and diseases.



Project implemented by

- Institute of Microbiology and Biotechnology, Academy of Sciences of Moldova (IMB), Moldova
- Politehnica University of Timișoara (UPT), Romania
- University of Food Technologies (UFT), Bulgaria
- Fundatia pentru Cultura si Invatamant "Ioan Slavici", Romania
- Lucian Balaga University of Sibiu (ULBS), Romania
- University of Rousse Angel Kanchev (UR), Bulgaria
- Transilvania University of Brasov (UNITBV), Romania
- Technical university of Moldova (TUM) Moldova
- Donetsk National University Economics and Trade named after M. Tugan-Baranovsky (DONNUET), Ukraine
- Kharkiv State University for Food Technologies and Trade (KSUFT), Ukraine
- National University of Food Technologies, (NUFT), Ukraine
- St. Petersburg State Institute of Technology (Technical University) (SIT), Russian Federation

Implementation period

01.01.2013 – 31.12.2015

Main activities

1. Integrate experiences from consortium countries into NUTRILAB project development;
2. Provide guidelines for sampling and administration;
3. Translate the NUTRILAB results and questioners from English to the language instruction in the respective countries;
4. Coordinate the NUTRILAB data collection for all consortium countries and partners and other participating countries;
5. Relevant theories, findings and methodology, and provide an overview of previous similar surveys to aid instrument development;
6. Collect data in each NUTRILAB consortium country.
7. data collection will be defined in different steps:
 - definition of keywords for search engines;
 - Web-browsing;
 - Compile a report/book towards the end of the project.

Results

- NUTRILAB seasonal schools which provide within a reasonably compact timeframe as a thorough and exhaustive treatment as possible of various topics in food labeling, but from a particular angle in each case
- Second North and East European Congress on Food (NEEFood-2013) which was held on May 26-29 2013 on the premises of the National University of Food Technologies

Applicability and transferability of the results

- Review of EU and national action plans, papers surveys;
- Review of EU and national R&D projects and programmes;
- Code and clean the national data files (all partners);
- Merge the national data files into the international data file, and clean it;
- Conduct general overall comparative data analysis and sum up findings from the project at large;



Financed through/by

Project number: 318946 - FP7-PEOPLE - 2012 - IRSES



Research team

Dumitru Ţucu
Dumitru Mnerie
Titus Slavici
Petru Andea
Hannelore Filipescu
Nicolae Lonţiş

Contact information

Prof. Dumitru TUCU, PhD
Department for Mechanical Machines, Equipment and Transportation
Bd. Mihai Viteazul, No.1, RO300222, Timisoara
Phone: (+40) 256 403 601;
Mobile: (+40) 744 264 650;
E-mail: dumitru.tucu@upt.ro
Web: <http://www.rosita.ro/nutrilab/news.html>

CHALLENGE – ADDRESSING THE FOUR KEY CHALLENGES OF SUSTAINABLE URBAN MOBILITY PLANNING

Goal of the project

Achieving sustainable, energy-efficient and environmentally friendly transport systems is one of the European key aims. Sustainable Urban Mobility Plans (SUMPs) are an instrument that contributes to reaching the climate and energy targets set by EU leaders and is promoted by the European Commission in relevant documents such as the Transport White Paper and Action Plan on Urban Mobility. Cities frequently face major barriers while creating their own Sustainable Urban Mobility Plans.

Short description of the project

In CHALLENGE (2013-2016), nine European cities, and eight supporting organisations have teamed up for overcoming the four most pressing challenges in sustainable urban mobility planning:

- Stakeholder participation and citizen involvement
- Institutional cooperation between sectors and disciplines
- Identification of the most effective policy measures
- Monitoring and evaluation of progress in SUMP development

For each challenge, the project cities analyze their local mobility situation, develop new strategies how to tackle their urban mobility problems and test solutions to overcome barriers in participation, cooperation, measure selection as well as monitoring and evaluation in more than forty pilot schemes.

Based on the lessons learned from the pilot schemes in the nine participating project cities, on the experience from the Follower Cities and on the results from the training activities, four CHALLENGE Kits will be developed as the main outputs of the project. Each kit will address one challenge and will consist of a comprehensive manual, a brochure and the relevant e-learning modules. The kits will be available in English, Czech, Croatian, Dutch, French, German, Hungarian, Polish and Romanian.

Both, cities with a lot of experience with integrated planning approaches and cities initiating the SUMP process will benefit from the results of CHALLENGE.



Implementation period

2013-2016

Main activities

- CHALLENGE will produce four practical CHALLENGE kits covering the identified SUMP challenges: participation of stakeholders, institutional cooperation, Identification of most effective measures and monitoring and evaluation. The kits will consist of a comprehensive manual, a quick-facts brochure and the relevant e-learning modules aimed at local practitioners and will guide you through participation processes, institutional cooperation, measure selection as well as monitoring and evaluation procedures;
- Four interactive SUMP Challenge Training Workshops are held for local planners and decision-makers. In addition, National SUMP Seminars and Summer Schools are organized in the Czech Republic, Croatia, Hungary, Poland and Romania.
- Learn with us online by registering for our free Online Learning Courses and benefit from the results of the workshops and seminars as well as the experiences from the CHALLENGE cities.

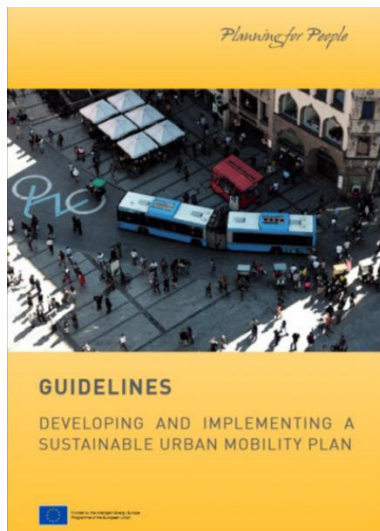

Financed through/by

IEE – Intelligent Energy Europe Programme of the European Union.

Research team

Associate Prof. Dumitru Iancului, PhD
Senior Lecturer Attila Gonczi, PhD

Project implemented by

The CHALLENGE cities:

- Amiens (France)
- BKK Centre for Budapest Transport (Hungary)
- Brno (Czech Republic)
- Dresden (Germany)
- Ghent (Belgium)
- Krakow (Poland)
- Timisoara (Romania)
- West Yorkshire Passenger Transport Executive, WYPTE (METRO) – Leeds (UK)
- Zagreb (Croatia)

SUMP Knowledge Partners:

1. Rupprecht Consult, Forschung & Beratung GmbH (Lead Partner) – Cologne (Germany)
2. The Association for Urban Transition, ATU – Bucharest (Romania)
3. Forschungsgesellschaft Mobilität - Austrian Mobility Research FGM – AMOR – Graz (Austria)
4. Institute for Transport Studies (ITS)
5. University of Leeds (UK)
6. Polis – European Cities and Regions Networking for Innovative Solutions – Brussels (Belgium)
7. Politehnica University of Timisoara (Romania)
8. Union of the Baltic Cities Commission on Environment UBC – Turku (Finland)
9. Urban Planning Institute of the Republic of Slovenia, UIRS – Ljubljana (Slovenia)

Contact information

Attila Iuliu GÖNCZI, PhD
Department of Mechanical Machines, Technology and Transportation
Address: Str. Remus, No. 14, 300191 Timisoara
Phone: (+40) 256 404 291
Mobile+40)740 073 951
E-mail: attila.gonczi@upt.ro
Web: <http://www.sump-challenges.eu/>

NOVEL TECHNIQUE TO ENHANCE THE SECURING LEVEL OF SECURITY PAPER USING THE SUPERPARAMAGNETIC FINGERPRINT OF MAGNETIC NANOPARTICLE DISPERSIONS → NANOMAG-SECURITY PAPER

Goal of the project

The continuous diversification of the paper securing techniques is one of the most important ways to erect fences against forgery attempts. The project aims to expand the diversity of high tech means for paper securing. The general objective of the project is to elaborate a new paper securing technique based on the superparamagnetic fingerprint of magnetic nanoparticles made of oxide compounds.

Short description of the project

The objective **is to elaborate a new paper securing technique** based on the superparamagnetic fingerprint of the magnetic nanoparticles.

Project implemented by

- Romanian Academy – Timisoara Branch (CO)
- SC CEPROHART SA (P1)
- SC ROSEAL SA Odorheiu Secuiesc (P2)
- SC Datronic – NCIP SRL (P3)
- National Institute of R&D for Izotopic and Molecular Technologies Cluj-Napoca (P4)
- Politehnica University of Timisoara (P5).

Implementation period

01.07.2014 – 30.06.2016

Main activities

- elaboration of superparamagnetic paper assortments with
 - low security level, using poly-disperse magnetic nanoparticles
 - high security level, using bi-disperse magnetic nanoparticles
 - white color, using core-shell (core/magnetic, shell/polymer) particles
- elaboration and testing the authentication method by static and dynamic magnetometry

Results

- methods for synthesis and characterization of oxide magnetic nanocomposites
- methods for elaboration and validation of magnetic loaded papers
- first instance validation of magnetic loaded papers

Financed through/by

Executive Unit for Financing Higher Education, Research, Development and Innovation (UEFISCDI)

Applicability and transferability of the results

The new method of securing paper using the superparamagnetic nanoparticles can be transferred to SC Ceprohart SA Braila. The transfer will contribute to:

- diversification of the product made in the national paper industry with simple brown paper secure and secure complex white paper,
- orientation of national industry to obtain a special paper grade with high complexity,
- increase the security level of specialty papers, difficult to fake on the internal market
- reduce the imports of security paper
- increase output and thus sales of security paper from Ceprohart.

Research centre

Research Centre for Engineering of Systems with Complex Fluids – Laboratory of Rheology and Magnetometry, from Politehnica University of Timisoara.

Research team

Dr. Vlad Socoliuc
Phys. Oana Marinica
Dr. Phys. Aurel Ercuta
Dr. Phys. Catalin Marin
Res. Assist. Florica Bălănean
Res. Assist. George Giula

Contact information

Phys. Oana MARINICA
Research Center for Engineering of Systems with Complex Fluids,
Laboratory of Rheology and Magnetometry
Bd. Mihai Viteazu No. 1, RO300223, Timisoara,
Tel.: (+40) 256 403700; (+40) 256 403701
Fax: (+40) 256 403700
E-mail: attila.gonczii@upt.ro
Web: <http://mh.mec.upt.ro/ccisfc/>

Dr. Vlad SOCOLIUC
Romanian Academy – Timisoara Branch
e-mail: vsocoliuc@gmail.com
Web: <http://vsocoliuc.wordpress.com/projects/nanomagsecuritypaper/>

MAGNETIC NANOFUID ROTATING SEAL SYSTEMS FOR HIGH PERIPHERAL SPEEDS HISPEED NANO MAG SEAL

Goal of the project

The project technical objective is to achieve at experimental model scale new leakage-free MNF sealing systems for high peripheral speeds (up to 30 – 70 m·s⁻¹) in the sealing area, designed to equip gas turbo-compressors.

Short description of the project

The project proposes the development of magnetic nanofluid (MNF) seals, which has significant advantages compared to conventional mechanical seals: hermetic sealing, exceptionally long lasting operation without intervention (5 years), minimal wear (only viscous friction), virtually zero contamination, optimal torque transmission, wide operating range (10⁻⁸ mbar – 10 bar), relatively simple and cost efficient execution

Project implemented by

- SC ROSEAL SA Odorheiu Secuiesc (C0)
- Romanian Academy – Timisoara Branch (P1)
- National Institute of R&D for Izotopic and Molecular Technologies Cluj-Napoca (P2)
- Politehnica University of Timisoara (P3)
- Romanina Research and Development Institute for Gas Turbines – COMOTI Bucharest (P4).

Implementation period

01. 07. 2014 – 30. 06. 2016

Main activities:

1. Laboratory and micropilot scale synthesis of magnetic nanofluids with carboxylic stabilizers and magnetizations between 400–1000 G. Samples characterization.
2. Conception, design and implementation of new experimental models of sealing systems with magnetic nanofluid, for high peripheral speeds
3. Testing and performance evaluation of new experimental models sealing systems with magnetic nanofluid, designed for high peripheral speeds

Results

- methods for synthesis and characterization of high magnetization nanofluids with carboxylic stabilizers
- experimental models for new sealing systems
- experimental models for sealing systems – innovative version with magnetic nanofluids with carboxylic stabilization

Applicability and transferability of the results

The expected results will facilitate design and low cost industrial scale production of an original sealing system with stable MNF at high temperatures (160 – 180 °C), for high peripheral speeds (up to 30 – 70 m·s⁻¹) in the sealing gap. They have some important advantages compared to conventional mechanical seals: hermetic sealing, high reliability, relatively simple construction, low execution cost. These performances indicate the market towards ROSEAL Co. is heading, namely the gas turbo-compressors in fertilizer and petroleum refining industry.

Financed through/by

the Ministry of Education, Research, Youth and Sports (MECTS) – Executive Unit for Financing Higher Education, Research, Development and Innovation (UEFISCDI) through the PN II Program Partnerships in Priority Areas, Collaborative applied research projects.

Research Centre

Research Centre for Engineering of Systems with Complex Fluids – Laboratory of Rheology and Magnetometry, from Politehnica University of Timisoara.

Research team

Tunde Borbath, PhD – Romanian Academy – Timisoara Branch
Phys. Oana Marinica
Assoc. Prof. Floriana D. Stoian, PhD
Assoc. Prof. Nicolae Crainic, PhD
Dr. Sorin Holotescu
Res. Assist. Florica Balanean
Res. Assist. George Giula

Contact information

Phys. Oana MARINICA
Center for Engineering of Systems with Complex Fluids, Laboratory of Rheology and Magnetometry
Address: Bd. Mihai Viteazu, No.1, R0300222, Timisoara
Phone: (+40) 256 403700; (+40) 256 403701
Fax: (+40) 256 403700
E-mail: oana.marinica@upt.ro;
Web: <http://www.roseal.eu/HiSpeedNanoMagSeal/etape.html>

HIGH MAGNETIZATION MAGNETIC NANOFUIDS AND NAO-MICRO-COMPOSITE MAGNETIZABLE FLUIDS: APPLICATIONS IN HEAVY DUTY ROTATING SEALS AND MAGNETORHEOLOGICAL DEVICES

Goal of the project

The project is oriented to the extension of the performances of rotating seals and adaptive motion control devices to meet the requirements of several well-defined new applications, by high and very high magnetization sealing fluids and new types of magnetorheological fluids to be synthesized.

Short description of the project

The project concept and objectives are illustrated schematically in figure the below:

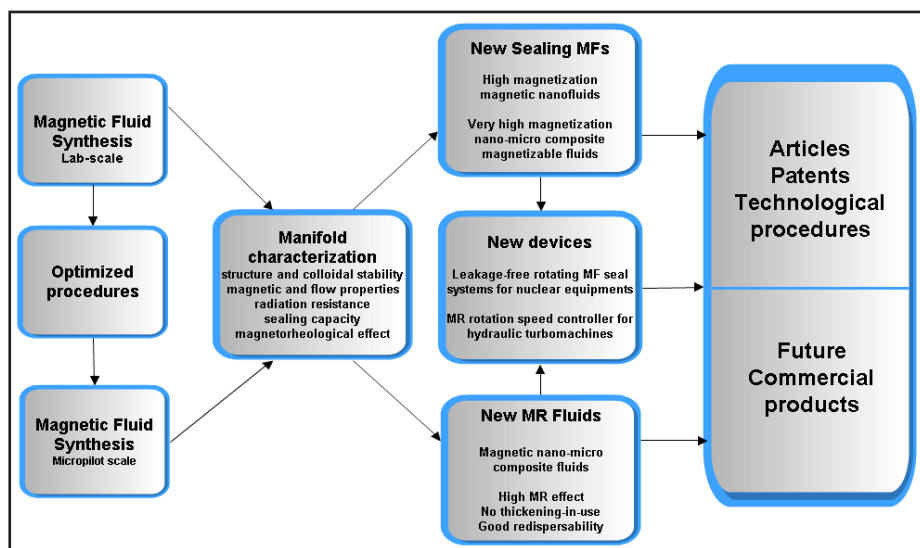

Project implemented by

- Romanian Academy – Timisoara Branch (Project coordinator),
- Politehnica University of Timisoara (Partner 1),
- S.C. ROSEAL S.A. Odorheiu Secuiesc (Partner 2)
- National Institute for R&D in Electrical Engineering ICPE-CA Bucharest (Partner 3).

Implementation period

23.07.2012 - 23.07. 2016.

Main activities

The main activities of the MagNanoMicroSeal project are:

- Synthesis and manifold characterization of magnetizable fluids for high pressure and heavy duty rotating seals and magnetorheological devices and, respectively,
- Design, fabrication and testing of leakage – free magnetofluidic rotating seal and magnetorheological (MR) control devices for well-defined applications/exploitation conditions.

Results

The main results of this project refer to the elaboration of the following **technological procedures**:

- synthesis of high magnetization sealing fluids;
- synthesis of nano-micro structured magnetorheological fluids;

and **qualification procedures**:

- magnetic nanofluids for sealing applications in nuclear equipments;
- magnetic nanofluids for rotating seals for nuclear equipments.

The project results will be disseminated through publications in leading scientific journals, through presentations at national and international scientific meetings. Also, the involved procedures, technologies, devices and know-how are favourable for patent applications, as well as for development and exploitation by the industrial partner from the project. .

The contributions of Politehnica University of Timisoara to this project refer mainly to complex magnetic, rheological and magneto-rheological analyses of the magnetic sealing fluids and nano-micro structured magnetorheological fluids. During the current year the Politehnica University team is in charge of the characterisation of the magnetic nanofluids to be used for seals submitted to heating and radiation.

Applicability and transferability of the results

The technological progress is strongly evidenced by future commercial products planned for the industrial partner S.C. ROSEAL S.A.: 16 new types of magnetically controllable fluids, 1 prototype and 3 functional models of magnetofluidic devices for nuclear and hydraulic power engineering.

Financed through/by

Ministry of National Education through the Executive Agency for Higher Education, Research, Development and Innovation Funding, Partnerships in priority S&T domains Program PN II, Collaborative Applied Research Projects PCCA 2011 – UEFISCDI

Research centre

- Research Center for Engineering of Systems with Complex Fluids, Politehnica University of Timisoara
- Magnetometry Laboratory, Rheology Laboratory, Numerical Simulation and Parallel Computing Laboratory
URL: <http://mh.mec.upt.ro/ccisfc/>

Research team

The project research team consists of 42 researchers, engineers and technicians

Dr. Ladislau Vekas – the project manager

Assoc.Prof. Floriana D. Stoian, PhD

Phys. Oana Marinica

Lect. Sorin Holotescu, PhD

Assoc. Prof. Nicolae Crainic, PhD

Lect. Andreea Dobra, PhD

Lect. Adelina Han, PhD

Res. Assist. Florica Balanean

Res. Assist. George Giula

Contact information

Dr. Ladislau VÉKÁS

e-mail: vekas@acad-tim.tm.edu.ro; vekas.ladislau@gmail.com

Tel.: (+40) 256 403 700; (+40) 256 403 703

Fax: (+40) 256 403 700

Assoc. Prof. Floriana D. STOIAN, PhD

Department of Mechanical Machines, Technology and Transportation

/Research Center for Engineering of Systems with Complex Fluids

Address: Bv. Mihai Viteazu, No.1, 300222. Timisoara

Phone: (+40) 256 403 671

Mobile:(+40) 744 597 308

E-mail: floriana.stoian@upt.ro

Web: <http://acad-tim.tm.edu.ro/magnanomicroseal/>

ENVIRONMENTAL ENERGY HARVESTING HYBRID SYSTEM BY PHOTOVOLTAIC AND PIEZOELECTRIC CONVERSION, DC/DC TRANSFORMATION WITH MEMS INTEGRATION AND ADAPTIVE STORAGE

Goal of the project

The design, building and testing of the prototype of a hybrid system for energy harvesting from the ambient through photovoltaic conversion, DC/DC transformation with MEMS integration and adaptive storage, will be carried out. A key novel component is the planar power micro-transformer for high frequency, with hybrid magnetic nanofluid/ferrite core and windings fabricated in MEMS technology, a part of the DC/DC converter. A second key component is the photovoltaic cell, which relies on novel solutions.

Short description of the project

A prototype with wireless sensors powered by the harvesting system will be designed, built and tested. In this endeavour, there will be prepared a dedicated magnetic fluid to be used as core of a micro-transformer, which will be designed accordingly and tested. Further, an experimental model of the energy harvesting hybrid system will be elaborated, designed and tested. Finally, a prototype for the harvesting device will be designed and tested for a particular application.

The current year research is targeting to accomplish the second activity listed above. The Politehnica University team, together with the Romanian Academy – Timisoara Branch (P2), is responsible for the preparation and characterization (in terms of magnetic, rheological, electrical, thermal and structural properties) of the magnetic fluid used as magnetic fluid core of the power micro-transformer.

Project implemented by

- National Institute for R&D in Electrical Engineering ICPE-CA Bucharest (Coordinator)
- Politehnica University of Timisoara (Partner 1)
- Romanian Academy – Timisoara Branch (Partner 2)
- Politehnica University of Bucharest (Partner 3)
- SYSCOM PROCESS CONTROL LTD (Partner 4).

Implementation period

01.07.2014 – 30.06.2016

Main activities

- elaboration of the experimental model of the energy harvesting hybrid system by photovoltaic conversion and DC/DC transformation with MEMS integration;
- design and testing of the experimental model of the energy harvesting hybrid system by photovoltaic conversion and DC/DC transformation with MEMS integration;
- design and testing of the prototype of the energy harvesting hybrid system by photovoltaic conversion and DC/DC transformation with MEMS integration.

Results

- The main result of the project will be the integration of an innovative photovoltaic conversion system and an original DC/DC converter, which utilizes a planar, spiral, MEMS, hybrid (magnetic nanofluid/ferrite) cored micro-transformer in an efficient device for energy harvesting.
- Regarding the use of a magnetic nanofluid core micro-transformer for the DC/DC converter, from the manufacturing point of view, it is expected that once the appropriate magnetic nanofluid characteristics are established, it will offer an easier way of obtaining the transformer core compared to a solid one.
- From the operating point of view, it is expected that by replacing the solid core with a liquid core will result in a better heat dissipation and reduction of the thermal stresses in the micro-transformer, leading to a longer life-cycle, maintaining or even improving the electric characteristics.

Applicability and transferability of the results

- The product can bring added value for further development as an end-product to the industrial partner.
- Possible applications are characterized by their placement in hard to reach places, isolated and without local and/or conventional sources.
- Among these are applications for industrial automation, monitoring of various parameters in industry, agriculture, surveillance and monitoring of perimeters.

Financed through/by

Financed through/by: Ministry of National Education through the Executive Agency for Higher Education, Research, Development and Innovation Funding, Partnerships in priority S&T domains Programm PN II, Joint Applied Research Projects PCCA 2013.

Research centre

Research Center for Engineering of Systems with Complex Fluids,
Politehnica University of Timisoara,
URL: <http://mh.mec.upt.ro/ccisfc/>



Research team

The research team of Politehnica University of Timisoara is consists of three senior researchers, one PhD student and two research assistants

Assoc. Prof. Floriana D. Stoian, PhD

Lect. Sorin Holotescu, PhD

Phys. Oana Marinica

Assoc.Prof. Nicolae Crainic, PhD

Res. Assist. Florica Balanean

Res. Assist. George Giula

Contact information

Assoc. Prof. Floriana D. STOIAN, PhD

Department of Mechanical Machines, Technology and Transportation
/Research Center for Engineering of Systems with Complex Fluids

Address: Bv. Mihai Viteazu, No.1, 300222. Timisoara

Phone: (+40) 256 403 671

Mobile:(+40) 744 597 308

E-mail: floriana.stoian@upt.ro

Web: <http://www.icpe-ca.ro/lib/files/asemems-harvest.pdf>

MICRO-MECHANICAL MODELLING OF CELLULAR MATERIALS WITH REFINEMENTS ON FRACTURE AND DAMAGE

Goal of the project

Cellular materials are widely used as cores in sandwich composites, for packing and cushioning. The main characteristics of foams are light weight, high porosity, high crushability and good energy absorption capacity. Present project propose to develop micro-mechanical models in order to predict the mechanical properties of cellular materials with a focus on modeling the fracture and the influence of damage on the mechanical response

Short description of the project

Project combines analytical methods, with numerical micro-mechanical finite element analysis and experimental investigations: materials testing and investigating the damage mechanisms by Digital Image Correlation and Thermoelastic Stress Analysis. The novelty of the project will be highlighted by the size and notch effect for cellular materials, and by investigating the effect of microstructural damage on the mechanical response of cellular materials.

Project implemented by

- Politehnica University of Timisoara
- Lublin University of Technology, Lublin, Poland
- Slovak Academy of Science, Bratislava, Slovakia
- Polymer Competence Center Leoben, Austria
- ILK, TU Dresden, Germany

Implementation period

05.10.2011 – 04.10. 2015

Main activities

- Better understanding of mechanical behavior of cellular materials.
- Develop micro-mechanical models to estimate mechanical properties of cellular materials.
- Implementation of constitutive material models in Finite Element Analysis.
- Investigating the size effect and notch effect on cellular materials Evaluating the behavior of cellular materials under dynamic (impact and fatigue) loading.
- identification of damage mechanisms in cellular materials using Digital Image Correlation and Thermography.
- Investigating the effect of microstructural damage on the mechanical properties of cellular materials.

Damage identification

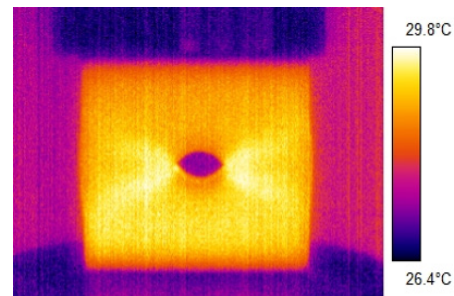

by thermography

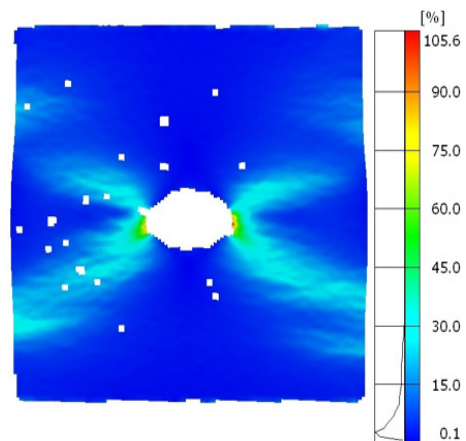

by Digital Image Correlation

Financed through/by

Grant PN-II-ID-PCE-2011-3-0456, Contract Nr. 172/2011, by Romanian Ministry of National Education, through UEFISCDI

Results

Our results provide a complete characterization of cellular materials, with enhancement on fracture and damage mechanisms. The main results of the project were published in ISI high impact journals:

- L. Marsavina, E. Linul, T. Voiconi, T. Sadowski, A comparison between dynamic and static fracture toughness of polyurethane foams, *Polymer Testing* 32 (2013) 673–680;
 - L. Marsavina, D.M. Constantinescu, E. Linul, D.A. Apostol, T. Voiconi, T. Sadowski, Refinements on fracture toughness of PUR foams, *Engineering Fracture Mechanics*, 129 (2014) 54–66;
 - D. Serban, E. Linul, L. Marsavina, N. Modler, Numerical evaluation of two-dimensional micromechanical structures of anisotropic cellular materials: case study for polyurethane rigid foams, *Iranian Polymer Journal* 24 (2015) 515–529;
 - D. Serban, L. Marsavina, N. Modler, Low-cycle fatigue behavior of polyamides, *Fatigue and Fracture of Engineering Materials & Structures* (Published OnLine);
 - L. Marsavina, D.M. Constantinescu, E. Linul, T. Voiconi, D.A. Apostol, Shear and mode II fracture of PUR foams, *Engineering Failure Analysis* (Published OnLine);
 - R. Negru, L. Marsavina, D. T. Voiconi, H. Filipescu, G. Belgiu, Application of TCD for brittle fracture of notched PUR materials, *Theoretical and Applied Fracture Mechanics* (Published OnLine);
- but also in other BDI journals and conference proceedings: Vth ICEAF 2015, Crack Path 2015 .

Testing of PUR foams for fracture toughness determination



Three point bending

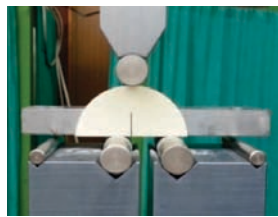

Asymmetric Semicircular Bending

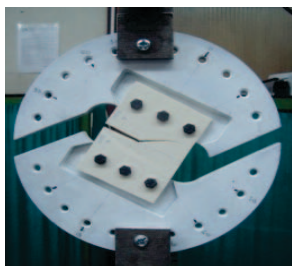

Single Edge Crack

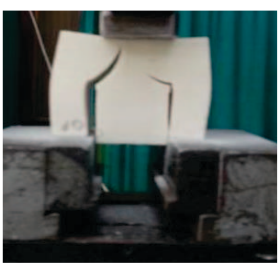

Compact Shear

Applicability and transferability of the results

- Results will be used by foams manufacturers Necumer and Spumotim to improve their technologies. Also, companies using foam components like TRW Automotive and Adidas will benefit by our developed micro-mechanical models to characterize their components and in the product design.

Fields of interest:

- Composite and cellular materials
- Mechanical testing
- Finite Element Analysis
- Fracture and Damage Mechanics

Research team

Prof. Liviu Marşavina, PhD – Project Manager
 Prof. Dan M. Constantinescu, PhD – Senior Researcher
 Emanoil Linul, PhD – Postdoc Researcher
 Cristian Neş, PhD – Postdoc Researcher
 Dragos A. Apostol, PhD – Postdoc Researcher
 Dan A. Şerban, PhD – Postdoc Researcher
 Eng. Tudor Voiconi, PhD student
 Eng. Florin Stuparu, PhD student

“There are no secrets to success. It is the result of preparation, hard work, and learning from failure.”

Colin Powell

Contact information

Prof. Liviu MARSAVINA, PhD
 Department Mechanics and Strength of Materials
 Address: Blvd. M. Viteazu, No. 1, RO300222, Timisoara
 Phone: (+40) 256 403 577
 E-mail: liviu.marsavina@upt.ro
 Web: http://www.marsavina.ro/index_MMMCM.html

HIGH PERFORMANCE LIGHTWEIGHT PANELS WITH A NEW OPTIMIZED DESIGN FOR ADVANCED AIRCRAFT STRUCTURES

Goal of the project

Design of aircraft panels, made of metal and composite material, flat and curved, with improved performances.

Short description of the project

Evaluation of the properties of some sandwich panels having an ultra light core, spatially folded. An increase of their performances with respect to the honeycomb core sandwiches is expected.

Project implemented by

- University Politehnica Bucuresti - Coordinator
- Straero S.A - Partner 1
- University Politehnica Timisoara - Partner 2
- INAS S.A. - Partner 3
- MART Mechanics S.R.L. - Partner 4

Main activities

- Characterization of three types of structural adhesives: Araldit AV138 M1 + HV 998, Araldit AW 106 + HV 953U and Bison using tensile tests and vibration excitation technique.
- Characterization of mechanical properties of metallic materials used for faces and cores in sandwich structures
- Static tests on single and double lap joints for the characterization for the characterization of the behavior of structural adhesives at ambient temperature.
- Numerical simulations of the behavior of doubler adhesive joints.
- Numerical simulation of the adhesive joints under four point bending

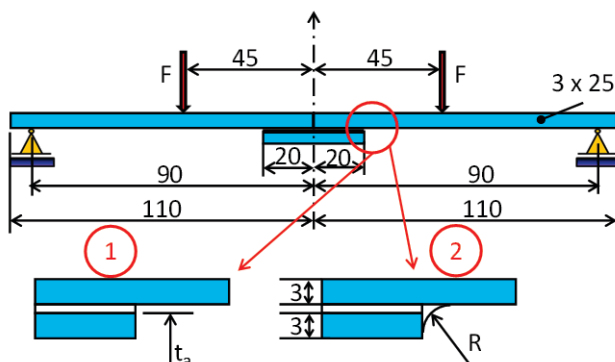

Geometry of the adhesive joint under four point bending

Implementation period

02.07.2012 – 30.06.2016

Results

Identification of new mechanical interconnection solutions for the skins, using elements that cross the core of the sandwich, which are simpler, more efficient and cheaper than those currently in use.

Skins interconnection is more convenient in the case of rigid polymeric foam core. Thus, the risk of delamination is reduced and this procedure is expected to increase the rigidity and resistance of the designed panels. Designing a new auxetic core structure.

The main results were published in:

- R. Negru, L. Marsavina L., C. Caplescu, H. Filipescu, Assessment of brittle mixed -mode fracture using the theory of critical distances, Proceedings of International Conference on Innovative Technology, IN-TECH 2013, Budapest 10-13.09.2013, p. 313-316
- R. Negru, L. Marsavina, H. Filipescu, C. Căplescu, T. Voiconi, Assessment of brittle fracture for PUR materials using local Strain Energy Density and Theory of Critical Distances, Theoretical and Applied Fracture Mechanics, (OnLine First)

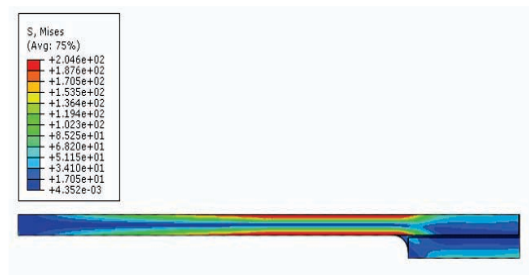

Equivalent stress distribution for the adhesive joint under four point bending

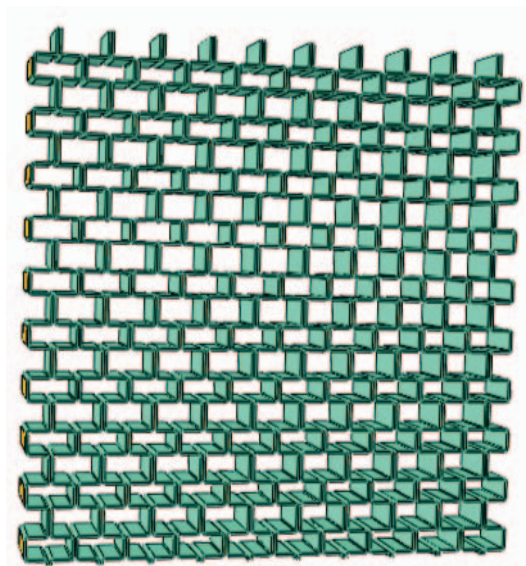

Auxetic core structure

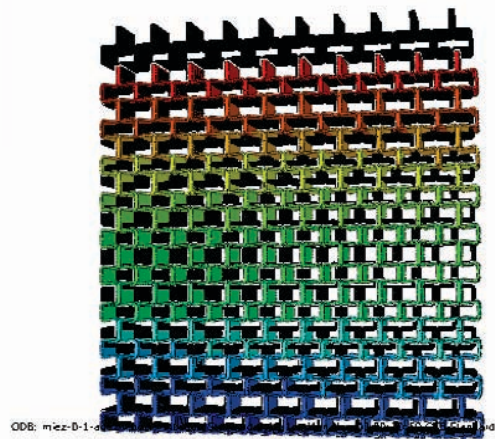
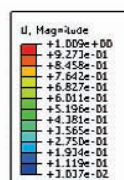

ODB: miez-D-1-
 Step: Step-1
 Increment: 1: Step Time = 1.000
 Primary Var: U, Magnitude
 Deformed Var: U, Deformation Scale Factor: +2.051e+01

Total displacement of the structure

Applicability and transferability of the results

Results and design solutions will be transferred to sandwich structure manufacturers to improve their technologies.

Also, companies involved on design of aircraft will benefit by our developed sandwich structures and hybrid assembly solutions.

Financed through/by

PN-II-PT-PCCA-2011-3.2-0068 CONTRACT 206/2012, Executive Agency for Higher Education, Research, Development and Innovation Funding (UEFISCDI)

Research centre

ICER - Research Institute for Renewable Energy

Research team

at University Politehnica Timișoara, ROMANIA

Prof. Liviu Marșavina, PhD

Prof. Nicolae Faur, PhD

Mihai Hlușcu, PhD

Radu Negru, PhD

Anghel Cernescu, PhD

“There are no secrets to success. It is the result of preparation, hard work, and learning from failure.”

Colin Powell

Contact information

Prof. Liviu MARSAVINA, PhD

Department Mechanics and Strength of Materials

Address: Blvd. M. Viteazu, No. 1, RO300222, Timisoara

Phone: (+40) 256 403 577

E-mail: liviu.marsavina@upt.ro

Web: <http://www.marsavina.ro>

NEW HAPTIC ARM EXOSKELETONS FOR ROBOTICS AND AUTOMATION IN SPACE (EXORAS)

Goal of the project

The project seeks to develop in Romania the capacity to design and manufacture special assemblies meant to work in the field of Robotic Exploration. The overall goal is to stimulate Romania's participation to international space missions and programs, in collaboration with ESA (European Space Agency), as its 19th member. The practical task is to develop a new haptic arm exoskeleton designed to enable in-space force-feedback telemanipulation with redundant robotic arms.

Short description of the project

EXORAS will provide a new haptic arm exoskeleton for robotic exploration. The exoskeleton is desired to explore future ways of commanding a manipulator arm in space. It will be created a prototype with special features of design, namely several shortcomings of previous telemanipulation systems will be removed. The new system pursues requirements regarding weight, ease of wearing and comfort of the human operator. The project assumes the full design, assembling and testing of the prototype. All aspects are taken into account: kinematics, dynamics, sensorics, wireless control, haptic feed-back, actuation, materials and so on.

Project implemented by

- Technical University of Cluj-Napoca – Coordinator
- University "Transilvania" Brasov – Partner 1
- Politehnica University of Timisoara – Partner 2 (146)

Implementation period

2012 – 2015

Main activities

- Research on the development of exoskeleton haptic systems for robotic exploration (existing solutions and development of new solutions; establishment of basic components with functional and technical specifications)
- Concept, design and assembly (mechanical design, kinematic analysis, development of control software, simulation)
- Testing and optimizing of prototypes (assembling, testing and optimizing of prototypes).

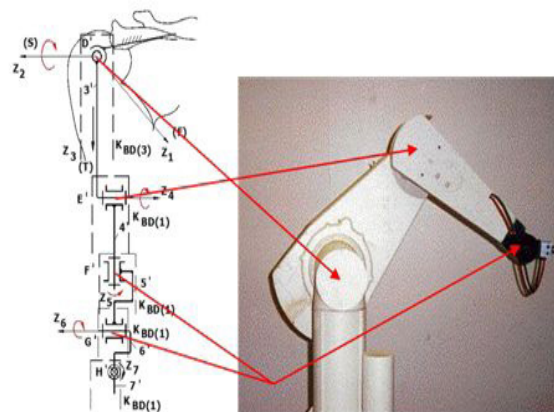

Fig. 1 Corresponding joints of exoskeleton and robot

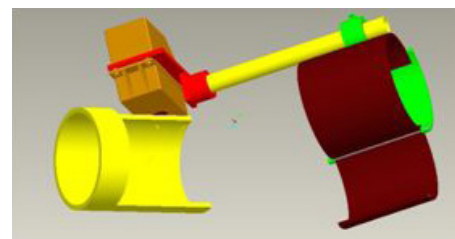

Fig. 2 CAD model of the exoskeleton with servo rotary drive

Results

At this stage, the research work lead to the design and partial implementation of new six solutions of exoskeleton arm. A generic scheme of the general concept from kinematic point of view is given in figure 1.

The design and practical solutions developed until now focused on the elbow and wrist joints. The six variants of exoskeleton under study use:

- servo rotary drive mounted directly on the shaft of the joint (fig. 2)
- linear actuation and transformation of motion (fig. 3)
- free motion and electromagnetic brake (movement transmission via a wire mechanism)
- free motion and electromagnetic brake
- haptic feedback generated by myostimulation
- haptic feedback generated by vibration modules.

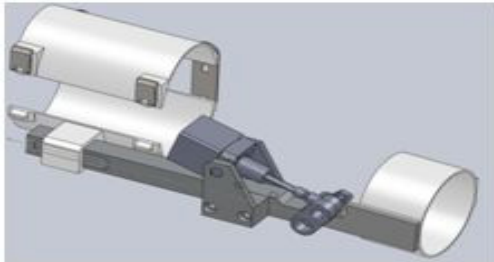

Fig. 3 CAD model of the exoskeleton with linear actuation

From the solutions above, the most convenient alternative proved to be the one using electromagnetic brakes. The CAD model of the assembly (5 degrees of freedom) is shown in figure 4.

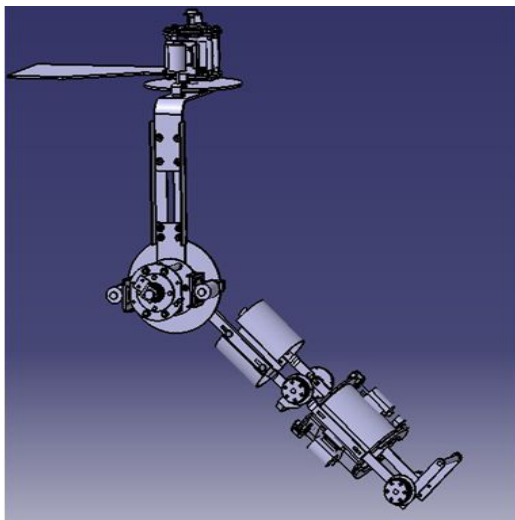

Fig. 4 CAD model of the exoskeleton (5 degrees of freedom) with free motion and electromagnetic brake

Research centre

Mechatronics&Robotics Research Center

Applicability and transferability of the results

- EXORAS fulfills entirely the goal of STAR program (of Romanian Space Agency) that aims the increasing of the research competitiveness for participation of academic entities to activities of ESA, included in the law no. 262/2011 regarding the membership status to ESA.
- This project is going to produce clear benefits to the consortium partners and beyond, regarding the competitiveness of the market for hi-tech mechatronics and robotics. In addition, the gain in knowledge is going to be transferred into higher-education support.

Financed through/by

Funded by the Romanian Space Agency (ROSA) through Contract nr. 13/19.11.2012 within the program STAR 2012 – Projects of RDI, Research direction: S1 Research

Research team

Erwin Lovasz
Valentin Ciupe
Dan Mărgineanu
Corina Gruescu
Iosif Cărăbaș
Eugen Zăbavă
Aurel Diaconu
Inocențiu Maniu
Valer Dolga
Marius Mateaș
Sanda Grigorescu
Cristian Pop

Contact information

Assoc. Prof. Erwin-Christian LOVASZ, PhD
Department of Mechatronics
Address: Bv. Mihai Viteazu 1, RO300222, Timisoara
Phone: (+40) 256 403 569
E-mail: erwin.lovasz@upt.ro

IMPROVEMENT OF THE TITANIUM WEAR RESISTANCE BY ELECTRON BEAM REMELTING OF THE PRE-DEPOSITED THERMAL

Goal of the project

Improvement of the exploitation performance of the titanium, especially wear behavior, without influencing its good corrosion resistance.

Short description of the project

Titanium is one of the most promising metals in field of high specific strength engineering. Although it offers attractive mechanical, chemical and physical properties, its surface properties are deficient, possessing poor fretting fatigue resistance and poor wear resistance properties. Thermal spray coatings is one of the most common ways to improve the surface characteristics of the materials being used in a wide range of industries to improve the abrasive, erosive, and sliding wear of machine components.

The proposed theme focuses on the improving of the titanium wear resistance by electron beam (EB) remelting of the pre-deposited oxidic powder Al₂O₃-TiO₂ using the high velocity oxygen fuel (HVOF) and atmospheric plasma spraying (APS) methods. The EB treatment may lead to the elimination of porosity, enhancement of the coating strength and chemical homogeneity, and the development of metallurgical bonding at the coating-substrate interface producing strengthened coatings adhesion.

Project implemented by

Politehnica University of Timișoara

Implementation period

02.09.2013-30.09.2016

Main activities

1. State of the art and perspectives evaluation in surface coatings technique used as a method in order to improve the wear behavior of the titanium;
2. Development of HVOF and APS sprayed Al₂O₃-TiO₂ coatings on the surface of titanium and their remelting using the electron beam (EB) method;
3. Analysis and characterization of the obtained HVOF sprayed Al₂O₃-TiO₂ coatings before and after the electron beam remelting treatment;
4. Study of the wear and corrosion behavior of the coatings before and after the electron beam remelting;

Results

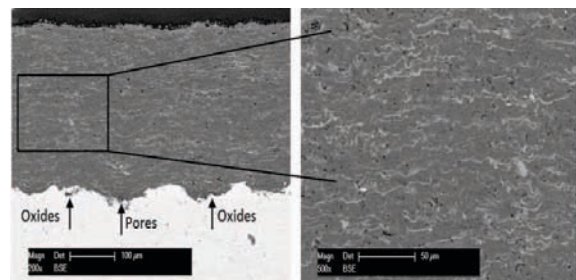

a) SEM micrographs of the deposited Al₂O₃-TiO₂ coatings using HVOF

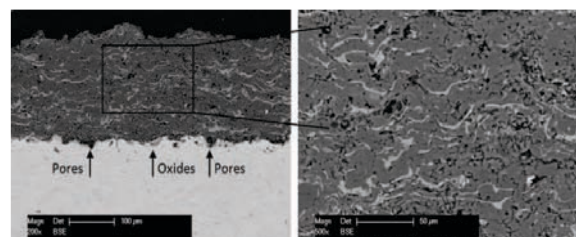

b) spraying process

Results

For the third stage of the project it has been obtained the following results:

- characterization of the predeposited Al₂O₃-TiO₂ coatings using the HVOF and APS spraying processes before and after the electron beam remelting treatment;

Applicability and transferability of the results

- The results which will be obtained in frame of the project will be transferred to companies in the field of automotive industry and not only. A
- Iso they will be presented to national and international conferences and published in scientific journals.

Research Centre

Research Centre for Processing and Characterization of Advanced Materials

Financed through/by

UEFISCDI - Executive Unit For Financing Education Higher Research Development And Innovation

Research team

Ion-Dragos Uțu - Project manager
Viorel-Aurel Șerban – senior researcher
Cosmin Codrean – senior researcher
Carmen Opreș – senior researcher
Iosif Hulka – postdoc researcher

Contact information

Lecturer Ion-Dragoș UȚU, PhD
Department of Materials and Manufacturing Engineering
Address: Bv. Mihai Viteazu, No.1, 300222. Timisoara
Phone: (+40) 256 403 656
E-mail: dragos.utu@upt.ro
Web: www.upt.ro/Informatii_UPT_504_ro.html

TECHNICAL CHARACTERISTICS RESEARCHING OF MODERN PRODUCTS IN MACHINE INDUSTRY (MACHINE DESIGN, FLUID TECHNICS AND CALCULATIONS) WITH THE PURPOSE OF IMPROVEMENT THEIR MARKET CHARACTERISTICS AND BETTER PLACEMENT ON THE MARKET

Goal of the project

The overall goal of the project are to increase the inter-university research cooperation in the fields of advanced methods of manufacturing, industry logistics and production engineering and the integration of research results in industry, trough students, doctoral students, professors and researchers, by facilitating the contacts with companies functioning in the influence areas of the partner universities.

Short description of the project

- The network project is designed to stimulate academic mobility within Central, Eastern and South Eastern Europe and to promote the university cooperation.
- The activities are carried out predominantly during the academic mobilities, planned for undergraduate students, PhD students and teachers, through specific actions: exchanging of information, knowledge and experience, participating to the common research projects, assisting with work on M.Sc. and Ph.D. thesis.
- Detailed description of the project and of activities are available on the CEEPUS web page : <https://www.ceepus.info/public/network/network.aspx>

Implementation period

01.09.2014 - 2015

Project implemented by

27 universities from 11 countries

Lead partner:

- University of Novi Sad, Faculty of Technical Sciences, Department of Mechanism and Machine Design

Project partners:

- POLITEHNICA UNIVERSITY OF TIMISOARA, Faculty of Engineering Hunedoara
- University of Sarajevo
- University of Banja Luka
- University of East Sarajevo
- Angel Kanchev University of Rousse
- University of Chemical Technology and Metallurgy
- Technical University of Liberec
- Jan Evangelista Purkyne Univ. in Ústí nad Labem
- Budapest University of Technology and Economics



- College of Nyíregyháza
- University of Montenegro
- University Sts. Cyril and Methodius - Skopje
- Poznan University of Technology
- "Politehnica" University of Bucharest
- Technical University of Cluj-Napoca, MB Faculty
- Technical University of Cluj-Napoca, Dep. ETM
- "Transilvania" University of Brasov
- "Eftimie Murgu" University of Resita
- "Lucian Blaga" University of Sibiu
- Belgrade University
- University of Nis
- University of Kragujevac
- University of Ljubljana
- Slovak Univ. of Technology in Bratislava, Fac. Mechanical Engineering
- Slovak Univ. of Technology in Bratislava, Fac. STU, Trnava
- Technical University in Košice

Main activities

- Courses, lectures, laboratory work and seminars.
- Joint Program, common elaboration of PhD and master thesis.
- Project activities combined with activities of Balkan Association of Power Transmissions—BAPT (Workshops, Summer courses and Scientific conferences, in cooperation with network partners, dedicated to special topics in machine design and fluid techniques).
- The network supports also the journal Machine Design (ISSN 1821-1259) and all CEEPUS local coordinators of partners are members of Scientific Editorial Board of the journal.



Index of main activities fields:

Teaching and training. Design. Marketing and advertising. Engineering, Manufacturing and Construction. Engineering and engineering trades. Computing and Computer use.

Milestones for the main activities:

- Designation of criteria, rules, schedules for students mobilities.
- Selection of supervisors on the host universities.
- Preparation of experimental investigation stands for research connected with the PhD thesis.
- Permanent professional e-discussions with the network partners. Project Management. Evaluation reports.
- Conclusion from final valuation meeting organized on the end of the academic year.

Results

- Joint Program: Optimization of Gear Transmissions. Design of Products and Machines
- Experimental investigation stands
- Professionals Visits of partner institutions: for the Politehnica University of Timisoara/Faculty of Engineering Hunedoara, 17 mobilities (10 incoming, 7 outgoing).
- Achievement of the requirements for teaching staff in teaching hours and and for students in obtained ECTS Credits, at the partner institutions.
- Final Report and valuation meeting, organized on the end of the CEEPUS academic year.

Financed through/by

- CEEPUS - "Central European Exchange Program for University Studies"



Applicability and transferability of the results

- Common criteria, rules, schedule for outgoing and incoming students, applicable in future students CEEPUS mobilities.
- Ensuring of possibility to develop future joint programs and joint thesis supervision.
- Stimulation of academic mobilities, in particular regional students and teachers mobilities within Central, Eastern and South - Eastern Europe



Research Team

DSc. MSc. Eng. Sinisa Kuzmanovic, PhD
 University of Novi Sad, Serbia, Network coordinator
 Assoc. Prof. Eng. Carmen Inge Alic, PhD
 Lecturer Eng. Ec. Vasile Alexa, PhD
 Lecturer Marius Călin Benea, PhD
 Lecturer Eng. Maria Laura Benea, PhD
 Lecturer Eng. Vasile George Cioată, PhD
 Assoc. Prof. Eng. Imre Kiss, PhD
 Lecturer Eng. Cristina Carmen Miklos, PhD
 Lecturer Eng. Imre Zsolt Miklos, PhD
 Lecturer Eng. Sorin Aurel Rațiu, PhD
 Lecturer Eng. Ovidiu Gelu Tirian, PhD
 Local CEEPUS Project coordinators from the 25 partner universities

Contact information

Assoc. Prof. Carmen Inge ALIC, PhD
 Department Engineering and Management
 Faculty of Engineering Hunedoara
 Address: Revolutiei Str. No. 5
 Postal Code 331128, Hunedoara
 Phone: (+40) 254207538
 Mobile: (+40) 723643278
 E-mail: carmen.alic@upt.ro
 Web: <http://www.fih.upt.ro/personal/carmen.alic/>

KNOWLEDGE MANAGEMENT-BASED RESEARCH CONCERNING INDUSTRY-UNIVERSITY COLLABORATION IN AN OPEN INNOVATION CONTEXT- UNIINOI

Goal of the project

In the present competitive climate, research knowledge and innovation are seen as the main distinguishing factors of firm success and as the basis of competitive advantages. Following a long tradition of research in the field of innovation, Open Innovation is an approach in which the boundaries of innovation are shifting from a situation where firms conduct research and development activities mainly internally, to a widespread collaboration and external knowledge source, to help them in achieving and sustain innovation. Although universities are seen among the most important partners with whom firms can cooperate, quantitative empirical evidence with regards to the development, evolution and sustainability of Industry-University relations in Open Innovation is still very scarce.

Short description of the project

- The general objective of the project is to sustain the research and development activities, based on knowledge management and carried out in collaboration by the consortium partners, for the development of an environment that promote Industry-University collaboration in Open Innovation.

Project implemented by

- University of Oradea
- Politehnica University of Timisoara
- Technical University of Cluj-Napoca
- S.C. EMSIL TECHTRANS S.R.L.

Implementation period

2014-2016

Main activities

1. The development of the collaborative research environment
2. The development of an Open Innovation environment between Industry-University
3. The development of a model for performance measurement of Industry-University collaboration in Open Innovation

Financed through/by

Ministry of National Education
The Executive Unit for Financing Higher Education, Research, Development and Innovation (UEFISCDI)

Research Team

Anca Draghici
Larisa Ivașcu
Călin Florin Băban
Laura Bacali
Silviu Dan Mînzat

Results

Articles in ISI Journals

- Baban, C.F., Baban, M., Suteu, M.D. (2015). Using a fuzzy logic approach for the predictive maintenance of textile machines, *Journal of Intelligent & Fuzzy Systems*, vol. Preprint, no. Preprint, pp. 1-8, 10.3233/IFS-151822 (Impact factor 2015=1.812).
- Oana, D., Suteu, M.D., Oana, I.P. (2016). The thinness degree study of wool yarns of different origins using the Uster machine, *Industria Textila* (accepted for publication, Impact factor 2015=0.475).

Articles in journals indexed in International Database

- Lakatos, E.S., Bercea, O.B., Moldovan, A., Bacali, L. (2015). Partnership between industry and university from an Open Innovation perspective, *Review of Management and Economic Engineering*, 14(1), pp. 173-182.
- Vaida, R., Bacali, L., Lakatos, E.S., Drăghici, A. (2015). Applications of knowledge management in social enterprises, *Review of Management and Economic Engineering*, 14(3), pp. 516-527.
- Baban, M., Baban, C.F., Buidos, T., Stanasel, I. (2015). A reverse engineering approach for the products development, *Nonconventional Technologies Review*, 19(1), pp. 12-17.
- Pancu, R., Mihăilă, S. (2015). The actuation mechanism concept used at the modular fixture system for TMA-AL 550 horizontal milling centre, *Nonconventional Technologies Review*, 19(3), pp. 32-36.
- Baban, M., Baban, C.F., Pele, A.V. (2015). A perspective on the usefulness of knowledge acquired within a simulated enterprise in reverse engineering, *ANNALS OF THE ORADEA UNIVERSITY. Fascicle of Management and Technological Engineering*, Volume XXIV (XIV), Issue 3, pp. 9-12.
- Draghici A., Cirtan M. A., Florea C. (2015). Some Consideration on Knowledge Management Implication on Organization's Competitiveness, *ACTA UNIVERSITATIS CIBINIENSIS – TECHNICAL SERIES*, Vol. LXVI, issue 1 (July 2015), DOI: 10.1515/aucts-2015-0024, pp. 41-46.

- Dragomir, G., Pancu, R., Mitran, T.A., Georgescu, L., Moca, S. (2015). Study regarding the car brake disc temperature variation during the lengthy braking, ANNALS OF THE ORADEA UNIVERSITY. Fascicle of Management and Technological Engineering, Volume XXIV (XIV), Issue 3, pp.57-60.
- Draghici A., Brad S. (2016). The Lean Agile Technology Transfer Model: Revisiting University-Industry Collaboration through the Gate of Innovation Process, International Journal of Sustainable Economy (accepted for publication)
- Cantor, A., Bacali, L., Muresan, M.C. (2015). About the role of marketing research, Review of Management and Economic Engineering, 14(4) (accepted for publication)
- Naghiu, M.O. (2015). Panmarketing – Towards a New Marketing!?, Review of Management and Economic Engineering, 14(4) (accepted for publication)
- 11. Brandușan, R., Bacali, L., Mureșan, C.M., Lakatos, E.S. (2014). Exploratory research regarding knowledge management, Review of Management and Economic Engineering, 13(4), pp. 789-796
- Draghici, A., Baban, C., Gogan, M., Ivascu, L. (2014). A knowledge management approach for the university – industry collaboration in open innovation context Procedia Economics and Finance, Elsevier (accepted for publication)
- Brandușan, R., Bacali, L., Mureșan, C.M., (2014). Exploratory research regarding knowledge management, Review of Management and Economic Engineering, 4, 789-796
- Lakatos, E.S., Bercea, O.B., Moldovan, A., Bacali, L.(2015). Partnership between industry and university from an Open Innovation perspective, Review of Management and Economic Engineering, nr 1.
- Draghici, A., Baban, C.F., Ivascu, L.V., Sarca, I. (2015). Key success factors for university–industry collaboration in open innovation, ICERI2015 Proceedings, 8th International Conference of Education, Research and Innovation, Seville, Spain 18–20 November 2015, pp. 7357-7365 (submitted to ISI Thomson for indexing)
- Draghici A., Foldvary-Schramko H. K., Baban C. F. (2015). Comparative Study on Knowledge Management Dimensions That Support Education and New Learning Technologies in Romanian Universities, EDULEARN15 Proceedings, 7th International Conference on Education and New Learning Technologies, Barcelona, Spain, 6th-8th July 2015, pp. 6726 – 6735 (submitted to ISI Thomson for indexing)
- Ivascu L., Mocan M., Draghici A., Turi A., Rus S. (2015). Modeling the Green Supply Chain in the Context of Sustainable Development, 4th World Conference on Business, Economics and Management (BEM-2015), Procedia Economics and Finance, Volume 26, ISBN 2212-5671, pp. 702–708 (submitted to ISI Thomson for indexing)
- Ivascu L., Cirjaliu B., Draghici A. (2015). Business model for the university-industry collaboration in open innovation, 3rd GLOBAL CONFERENCE on BUSINESS, ECONOMICS, MANAGEMENT and TOURISM, 26-28 November 2015, Rome, Italy (submitted to ISI Thomson for indexing)
- Lakatos, E.S. (2015). The benefits of IT tools in innovation process for SME Sustainability, Third International Conference on Advances in Management, Economics and Social Science – MES 2015, Rome, Italy, 10-11 December (acceptat spre publicare)

Participations at conferences

- Draghici A., Baban C. F., Gogan M. L., Ivascu V. L. (2015). A Knowledge Management Approach for The University-Industry Collaboration in Open Innovation, Procedia Economics and Finance, vol. 23/2015, pp. 23-32, 2nd GLOBAL CONFERENCE on BUSINESS, ECONOMICS, MANAGEMENT and TOURISM, 30-31 October 2014, Prague, Czech Republic, doi:10.1016/S2212-5671(15)00377-9
- Draghici, A., Ivascu, L.V., Baban, C.F., L. Bacali, L. (2015). University-industry collaboration in open innovation, INTED2015 Proceedings, 9th International Technology, Education and Development Conference, Madrid, Spain 2-4 March 2015, pp. 6278-6287 (submitted to ISI Thomson for indexing)

Products

- The Portal of Knowledge Management - KM Portal
- (http://imtuoradea.ro/PNII_337_platforma/platforma.php)

Others

- The model survey questionnaire to identify the main dimensions of the Industry- Universities collaboration in Open Innovation
- Report on the ontology of the Industry- Universities collaboration in Open Innovation
- Knowledge maps of the Industry- Universities collaboration in Open Innovation

Contact information

Prof. Anca Draghici, PhD
 Department of Management
 Adress: Str. Remus, No. 14, RO 300191, Timisoara,
 Tel.: (+40) 256 404 037; (+40) 256 403 061
 E-mail: anca.draghici@upt.ro
 Web: http://imtuoradea.ro/PNII_337/index_en.php

THE IMPACT OF THE ECONOMIC AND FINANCIAL STABILITY ON INVESTMENTS, INNOVATION PROCESS AND ENTREPRENEURIAL ACTIVITY IN THE EU

Goal of the project

The project has three general objectives. First, it is about the setup of a young research team that will approach an interdisciplinary subject, of European interest, and that will enhance the capacity of Romanian researchers to successfully apply for European financing instruments. Second, the project intends to increase the number of full time researchers as well as to augment the quality of publications of the young researchers who will be part of the team. Third, the project allows to increase the integration of the project leader (with macroeconomic background), in the research activity of the management school where he acts.

Short description of the projects

The investment, innovation and entrepreneurial activities are mainly analyzed at microeconomic level. Their macroeconomic determinants advanced by researchers refer to the market size, productivity, trade openness and R&D expenditure. However, the economic and financial stability plays an important role in promoting investments, in influencing the entrepreneurs' decisions and in affecting the national innovativeness capacity. These aspects, extremely important for the European strategy for economic recovery and job creation, are not sufficiently explored in the literature, while their empirical investigation is practically inexistent, especially at a sectorial level.

Against this background, using a panel approach, different cointegration models with structural breaks and the Amadeus statistics, the aim of the project is to analyze the relationship between stability and investments, innovation and entrepreneurship in EU countries, following three research directions.

First, we analyze the link between stability and investments, considering the sectorial particularities of the investments' determinants. Next, we investigate the role of the stability in enhancing the innovativeness capacity. Finally, we explore the relationship between the economic stability and the entrepreneurial activity, to investigate the economic sectors where the entrepreneurial decision is sensitive to the evolution of the macroeconomic fundamentals.

Implementation period

01.10.2015 – 30.09.2017

Financed through/by

- Executive Agency for Higher Education, Research, Development and Innovation Funding – UEFISCDI, Bucharest, Romania.

Research Centre

Research Centre for Engineering and Management

Project implemented by

Politehnica University of Timisoara, Management Department

Main activities

- Research deployed on three axes: stability and investments, stability and entrepreneurial activity, stability and innovation process
- Manipulation of AMADEUS database
- Generation of results using EViews software
- Creation of research networks
- Participation to research traineeships/stages and summer schools
- Dissemination of results in journals and conference proceedings.

Results

- 15 papers published
- 12 conference participation
- 4 research stages
- 1 workshop organization

Applicability and transferability of the results

- The results will allow a deep understanding of the role financial stability plays on investment, entrepreneurship and innovation
- The results will underline the main drivers of firms' performances across Europe
- The results will support economic policy decisions and investment decisions in different EU countries and economic sectors.

Research Team

Assoc. Prof. Claudiu Tiberiu ALBULESCU, PhD – Project Manager
 Assoc. Prof. Matei TAMASILIA, PhD – Senior researcher
 Lecturer Ilie Mihai TAUCEAN, PhD – Senior researcher
 Assist. Prof. Serban MICLEA, PhD – Postdoc Researcher

Contact information

Assoc. Prof. Claudiu ALBULESCU
 Department of Management
 Adress: Str. Remus, No. 14, RO 300191, Timisoara,
 Tel.: (+40) 256 404 053
 Mobile: (+40) 743 089 759
 E-mail: claudiu.albulescu@upt.ro
 Web: <https://sites.google.com/site/claudiutiberiualbulescu/>

NEW APPROACH OF USING IONIC LIQUIDS (ILS) AS GREEN EXTRACTANTS IN THE ADSORPTION PROCESS OF RADIONUCLIDES FROM WASTE AQUEOUS SOLUTIONS

Goal of the project:

The overall goal of the proposed project is to investigate a new approach of using the room temperature ionic liquid (RT IL) as extractants impregnated onto various solid supports in the adsorption process of radionuclides from waste aqueous solutions. The project has an interdisciplinary character presenting an integrated concept of waters depollution with radionuclides content

Short description of the project

Various ionic liquid impregnated materials are obtained and after a complex characterization they are used in the adsorption process of different radionuclides from synthetic and real aqueous solutions.

Project implemented by

Faculty of Industrial Chemistry and Environmental Engineering

Implementation period

01.05.2013–30.09.2016

Main activities

1. Impregnation of various ILs onto various solid supports using various methods of impregnation (2013);
2. Characterization of the obtained ionic liquid impregnated materials (2013);
3. Removal of various radionuclides from aqueous solutions through adsorption onto obtained ionic liquids impregnated materials: batch studies - equilibrium, kinetic and thermodynamic studies. (2013, 2014);
4. Removal of various radionuclides from aqueous solutions through adsorption onto obtained ionic liquids impregnated materials: Column studies (2015);
5. The influence of competitive cations (eg. Na, K and Be) and the concomitant extraction of various radionuclides (2015, 2016);
6. Desorption of the radionuclides and recycle of ionic liquid impregnated material. Use of various cycle adsorption-desorption (2015; 2016).

Applicability and transferability of the results

The project topic is answering a well-defined problem/question with practical relevance – in the waters depollution with radionuclides content, opening and establishing the new science based on both adsorption technology and ionic liquids. The results may also be transferred to the students as part of their training in the field of water and waste water treatment, adsorption process and obtaining of new functionalized materials field.

Results

The use of ionic liquid impregnated materials as adsorbents in the removal process of radionuclides from aqueous solutions presented very good performance in the removal process of radionuclides from waste aqueous solutions because the adsorbent properties of the solid supports and the advantageous properties of ILs were combined. All results were validated by publication in scientific journals and presentation at scientific conferences: 6 articles published in ISI indexed journals, 5 articles published in BDI indexed journals, and 19 articles presented at international conferences, one patent application.

Financed through/by

UEFISCDI/Human Resources - Research projects to stimulate the establishment of young independent research - TE

Research Centre

Research Institute for Renewable Energy

Research team

Lecturer Lavinia Lupa, PhD
Prof. Petru Negrea, PhD
Assoc. Prof. Adina Negrea, PhD
Scientific Researcher Mihaela Ciopec, PhD
Lecturer Raluca Vodă, PhD
Eng. Alexandra Bogin

Contact information

Lecturer. Lavinia LUPA, PhD
Department of Applied Chemistry and Inorganic Compounds and Environmental Engineering
Address: Bd. Vasile Pârvan, No. 6, RO 300223, Timisoara
Phone: (+40) 256 404 192
Fax (+40) 256 403 060
E-mail: lavinia.lupa@upt.ro
Web: http://www.chim.upt.ro/Facultatea-de-Chimie-Industrial-a-si-Ingineria-Mediului_PN-II-RU-TE-2012-3-0198_2XW.html

NANO-ENHANCED ELECTROCHEMICAL GREEN TECHNOLOGY FOR ADVANCED INTEGRATED WATER TREATMENT AND QUALITY CONTROL

Goal of the project:

The main goal of this project is to develop a green electrochemical technology aimed at the use of electrochemical electrode materials based on nanostructured carbon for both destroying priority hazardous organic pollutants from water and to monitor them before / after application of electrochemical processes of destruction, envisaging the exploitation of the dual character of the electrode materials and electrochemical techniques, by creating the right framework for achieving the high research level.

This project aims to explore potential use of nano-enhanced electrochemical dual green technology to improve access to clean water.

Short description of the project

Based on the results obtained in our previous studies for the oxidation of pollutants in aqueous solutions for their degradation and/or their detection on the carbon-based electrodes, specific objectives have been set in this project:

1. Elaboration and manufacturing of some new electrodes types based on nanostructured carbon and Ag/Cu/TiO₂ modified zeolite with enhanced electro(photo)-catalytic activity;
2. Manufacturing, design and geometry conditions of electrodes for degradation and monitoring applications;
3. Setting-up the optimal conditions for the degradation and mineralization of priority organic pollutants (POPs) from water;
4. Elaboration of the electrochemical detection scheme;
5. Integration of the electrochemical detection methods within the control of the degradation and mineralization of POPs in aqueous solutions.
6. Development of a new nano-enhanced electrochemical green dual technology for integrated water treatment and control.

Continuous development of nanomaterials and nanotechnology offers more effective and sustainable solutions for the environmental protection. Based on the well-known potential of the electrochemical processes in environmental remediation and quality monitoring, integration of nanomaterials in chemical composition of the electrode, which represents the key of these processes performances, gives them superior characteristics suitable for the practical applications. Also, the development of pulsed electrochemical techniques was not sufficiently explored and exploited to improve process efficiency.

Project implemented by

Faculty of Industrial Chemistry and Environmental Engineering

Implementation period

2011 - 2016

Main activities

1. Elaboration of new composite materials based on carbon nanotubes (CNT)/carbon nanofibers (CNF) in epoxy matrix as electrode materials for oxidation of POPs from water;
2. Characterization of new composite materials based on CNT/ CNF in epoxy matrix and electrode design;
3. Composite electrode obtaining and selection for application in degradation and/or detection of POPs from water;
4. Assessment of electro(photo)catalytic performance of the selected electrodes in advanced degradation/mineralization of POPs;
5. Assessment of the electroanalytical performance of the electrode in detection of POPs from water. Optimization of the electroanalytical method;
6. Integration and optimization of the electrode materials and electrochemical techniques in advanced wastewater treatment and process control.
7. Dissemination of the project relevant results to the scientific community through publication in peer-reviewed national and international journals, and also to the stakeholders in water treatment technologies (industrial agents, authorities in the field of water, water-sewage operators).

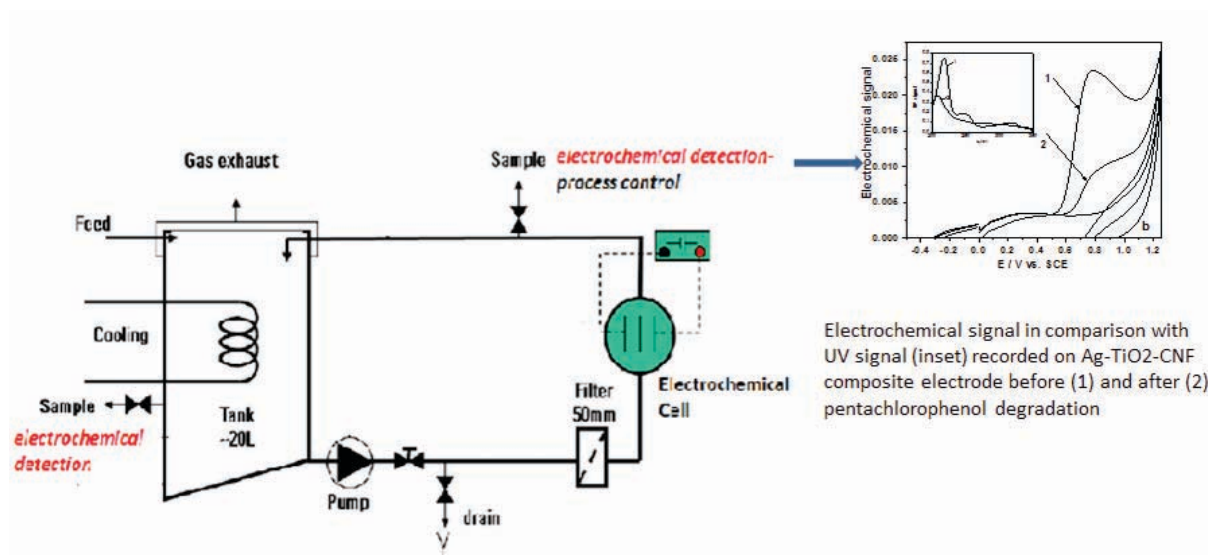

Electrochemical signal in comparison with UV signal (inset) recorded on Ag-TiO₂-CNF composite electrode before (1) and after (2) pentachlorophenol degradation

Results

- Comparative monitoring of optimized electrochemical treatment of priority organic pollutants from water using the electrochemical detection and conventional methods.
- Optimization of the composition of the electrode material and the electrochemical technique for integrative electrochemical degradation and process control. Published papers .

Applicability and transferability of the results

The nano-enhanced electrochemical green dual technology which will be elaborated at the end of this project could be scaled and tested for application at pilot level in water treatment.

Financed through/by

Executive Unit for Financing Higher Education, Research, Development and Innovation - UEFISCDI

Research team

Prof. Florica Manea, PhD
 Prof. Rodica Pode, PhD
 Scientific Resercher Aniela Pop
 Anamaria Baciu- researcher assistant
 Sorina Motoc- researcher assistant

Contact information

Prof. Florica MANEA, PhD
 Department of Applied Chemistry and Inorganic Compounds and Environmental Engineering
 Address: Bd. Vasile Pârvan, No. 6, RO 300223, Timisoara
 Phone: (+40) 256 403 070
 E-mail: florica.manea@upt.ro
 Web: <http://www.3waves.ro/id165upt/>

INTEGRATED SYSTEM FOR REDUCING ENVIRONMENTAL AND HUMAN-RELATED IMPACTS AND RISKS IN THE WATER USE CYCLE

Goal of the project:

The main goal of the project is to develop and implement an integrated system of innovative technologies and management instruments for reducing environmental impacts and associated human health risks caused by water quality aspects in the entire water use cycle: water abstraction, treatment, distribution, use, wastewater collection, wastewater treatment and discharge and reuse.

Short description of the project

The specific objectives were defined at the level of whole water usage cycle:

1. Development of specific instruments for the identification, quantification and control of environmental impacts and risks, over the water use cycle, applied to regional water operators;
2. Development of the capacity of collaboration and knowledge transfer between the universities and the regional water operators in Iasi and Timis counties for the control of the environmental impacts and human health risks in the water use cycle;
3. Development of the research and institutional capacities of the universities and water regional operators in Iasi and Timis counties for facilitation of the further cooperation at national and international scale;
4. Development of capacities and competitiveness of Romanian researchers and staff of regional water operator, as well as of the national partnerships contributing to environmental sustainability.
5. Dissemination of relevant results of the project to the scientific community through publication in peer reviewed international journals, ISI ranked, participation in international conferences, workshops, trainings/research stages, as well as to interested stakeholders (industrial agents, water authorities, waterworks companies, agriculture and services, EPAs, local and regional development agencies and authorities, NGO's and societal organizations).

Project implemented by

- Technical University "Gheorghe Asachi" Iasi - Lead partner
- Politehnica University of Timisoara - P1
- SC AQUATIM SA Timișoara - P2
- SC APAVITAL SA Iasi - P3

Implementation period

2012 - 2016

Main activities

1. Integrated evaluation of the water use cycle;
2. Studies on impact and risk minimization through innovative water treatment process (removal of nitrate, nitrite and natural organic matter);
3. Studies on impact and risk minimization through innovative wastewater treatment processes (removal of priority organic pollutants);
4. Pilot-scale studies on impact and risk minimization in water and wastewater treatment for reuse.
5. Development and testing of integrated management instruments for impact and risk prediction and minimization over the water use cycle;

Results

- Assessment of electrocoagulation, electrooxidation and electroreduction processes in drinking water treatment;
- Schematic flow for the flexible pilot plant for the drinking water treatment
- Design and elaboration of the flexible pilot plant for the drinking water treatment

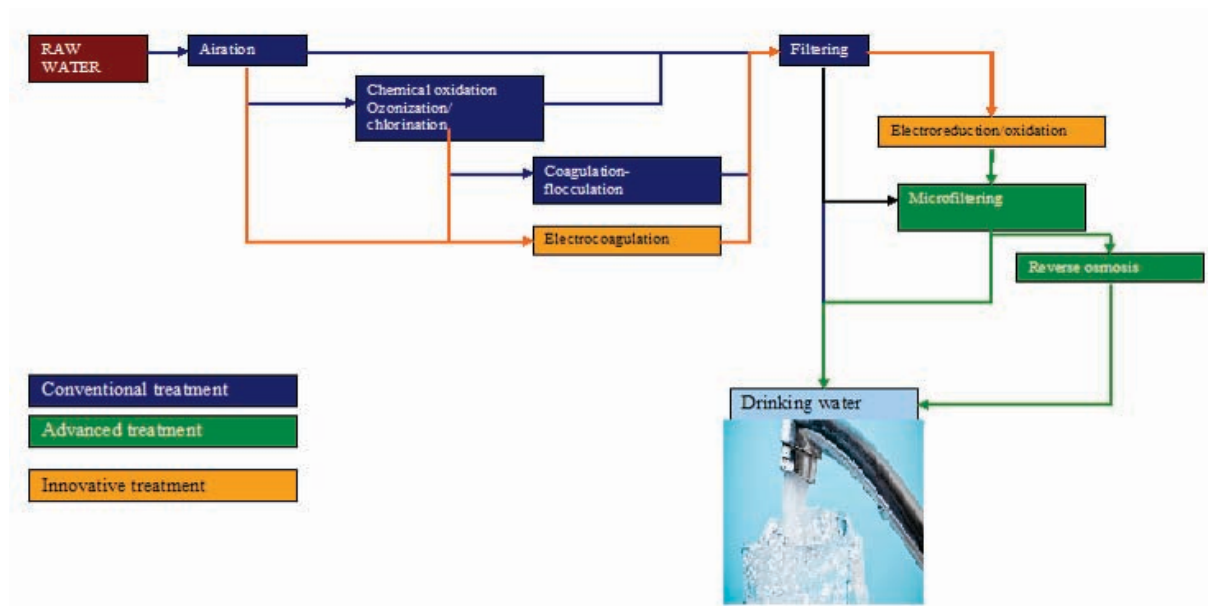

Applicability and transferability of the results

Two regional water operators, i.e. Aquatim and Apavital are involved in this project in order to test and apply innovative technologies for water and wastewater treatment in direct relation with specific water quality problems.

Financed through/by

Executive Unit for Financing Higher Education, Research, Development and Innovation - UEFISCDI

Research team

Prof. Florica Manea, PhD
 Prof. Rodica Pode, PhD
 Scientific Resercher Aniela Pop
 Assist. Prof. Laura Coheci, PhD
 Anamaria Baciu- researcher assistant
 Sorina Motoc- researcher assistant
 Magdalena Ardelean- researcher assistant
 Agnes Jakob- researcher assistant

Contact information

Prof. Florica MANEA, PhD
 Department of Applied Chemistry and Inorganic Compounds and Environmental Engineering
 Address: Bd. Vasile Pârvan, No. 6, RO 300223, Timisoara
 Phone: (+40) 256 403 070
 E-mail: florica.manea@upt.ro
 Web: <http://www.ch.tuiasi.ro/cercetare/parteneriate/watuser/Home.htm>

NEW FABRICATION CONCEPT OF SILVER NANOWIRE/POLYANILINE TRANSPARENT, CONDUCTIVE AND FLEXIBLE ELECTRODES FOR SOLAR CELLS

Goal of the project

The aim of the project is to develop transparent, conductive and flexible electrodes for solar cells based on silver nanowire/polyaniline hybrid materials and to offer a new technical solution to decrease the sheet resistance of the silver nanowires embedded in the polymer matrix. Low melting point metallic nanoparticles (In and Sn) will be deposited on the surface of silver nanowires, allowing to weld the nanowires and to obtain a network with high electrical conduction paths.

Short description of the project

A great challenge in the actual research of solar-to-electricity conversion is the construction of flexible solar cells. Although indium tin oxide (ITO) deposited on plastic is traditionally used for organic solar cells and light emitting diodes, solutions are searched to replace the ITO layer and to manufacture cheap transparent conducting electrodes. Silver nanowires (AgNWs) are a promising candidate to replace ITO due to their high electric conductivity and corrosion resistance, but there is still the issue of increased resistance on wire contacts. The proposed solution involves the modification of the AgNWs by deposition on their surface of metallic nanoparticles with low melting temperatures like tin and indium. The modified nanowires will be suspended in a proper medium to form an electroconductive ink that will be deposited on flexible polymeric sheets. The nanowires will be welded by thermal treatment, with and without the application of static pressure

Project implemented by

Politehnica University Timisoara
Department of Applied Chemistry and Inorganic Compounds and Environmental Engineering

Implementation period

02.09.2013–30.09.2016

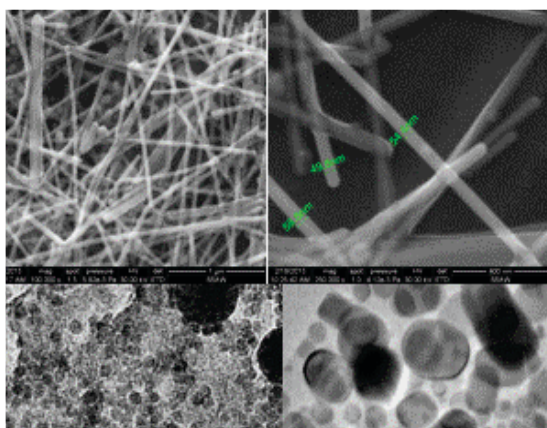

Main activities

Research activities:

- Synthesis and characterization of silver nanowires with controlled aspect ratio (2013).
- Synthesis and characterization of indium and tin nanoparticles (2014).
- Development and characterization of transparent conductive electrodes on flexible substrates using silver nanowires and assessment of their electrical and optical properties (2014)
- Synthesis and characterization of silver nanowires modified with tin and indium nanoparticles and preparation of electroconductive inks based on modified Ag nanowires (2015)
- Manufacturing of modified Ag nanowires-based flexible, transparent and conducting electrodes, with high diffuse transmittance and low sheet resistivity by coating the electro-inks on flexible substrates (2015)
- Deposition of a conducting polymer on previously manufactured electrodes and their use in the construction of dye-sensitized solar cells (2016).

Results

- Samples of silver nanowires
- Samples of indium and tin nanoparticles
- Samples of transparent and conductive electrodes

ISI publications:

- R. Banica, D. Ursu, C. Sarvas, S. F. Rus, S. Novaconi, A. Kellenberger, A.V. Racu, T. Nyari, Electrical properties optimization of silver

International conferences

- R. Banica, R. Baies, R. Bucur, C. Locovei, A. Kellenberger, T. Nyari, Study of liquid phase synthesis of silver nanowires for solar cell applications, 3rd European Energy Conference – E2C 2013, October 27–30, 2013 – Budapest, Hungary.
- R. Banica, R. Baies, D. Ursu, M. Poienar, T. Nyari, Silver nanowires synthesis in the PVP-silver-chloride system, ECO IMPULS 2013, November 7–8, Timisoara, Romania.

- R. Banica, C. Sarvas, S.F. Rus, S. Novaconi, A. Kellenberger, T. Nyari, Optimization of the electrical and mechanical properties of transparent electrodes based on silver nanowires supported on polyethylene terephthalate, International Symposium on Flexible Organic Electronics ISFOE 14, 7-10 July, 2014 – Thessaloniki, Greece.
- R. Banica, C. Sarvas, S.F. Rus, D. Ursu, S. Novaconi, A. Kellenberger, T. Nyari, Manufacture of ultrathin transparent electrodes based on silver nanowires with application to three-dimensional solar cells, International Symposium on Flexible Organic Electronics ISFOE 14, 7-10 July, 2014 – Thessaloniki, Greece.
- L. Cseh, C. Locovei, O. Marinica, A. Kellenberger, T. Nyari, R. Banica, Synthesis and characterization of indium nanoparticles as precursor for solar cells, New trends and strategies in the chemistry of advanced materials with relevance in biological systems, technique and environmental protection. New trends and strategies in the chemistry of advanced materials, 5-6 June, 2014 – Timisoara, Romania

Applicability and transferability of the results

The manufacture of electroconductive inks based on silver nanowires covered with metal nanoparticles with low melting points is expected to have wide technological applications and an important economic impact. This type of conductive inks may be used not only for flexible solar cells but also for other optoelectronic devices, such as flexible LEDs, organic thin film transistors, organic lasers and photo detectors, electronic paper, disposable sensors, low-cost smart cards and RF identification tags, or flexible arrays of plastic microphones.

Financed through/by

UEFISCDI - Executive Agency for Higher Education, Research, Development and Innovation Funding, Programme IDEAS, Exploratory Research Projects.

Research centre

Research Centre for Environmental Science and Engineering

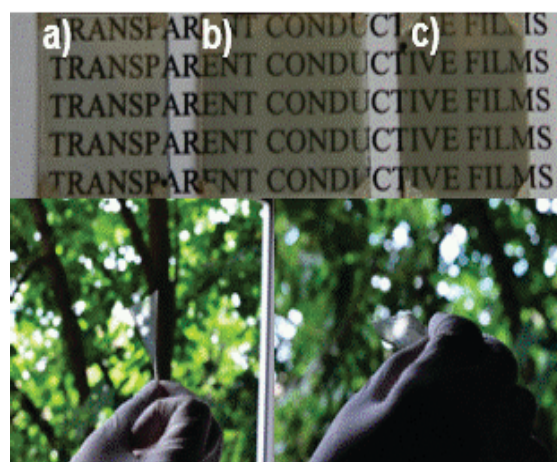

Research team

Assoc. Prof. Andrea Kellenberger, PhD - project manager
Prof. Nicolae Vaszilcsin, PhD – senior researcher
Terezia Nyari - senior researcher
Liliana Cseh - senior researcher
Radu Nicolae Banica -postdoctoral researcher
Cosmin Locovei- postdoctoral researcher
Radu Baies- postdoctoral researcher
Mircea Laurentiu Dan - PhD student
Alin Bucur- PhD student
Daniel Horatiu Ursu- PhD student
Paul Cristian Capota- master student

Contact information

Assoc. Prof. Andrea KELLENBERGER, PhD
Department of Applied Chemistry and Inorganic Compounds and Environmental Engineering
Address: Carol Telbisz Street, No. 6, RO300001, Timisoara
Phone: (+40) 256 404 178
Fax (+40) 256 403 060
E-mail: andrea.kellenberger@upt.ro
Web: http://www.chim.upt.ro/Facultatea-de-Chimie-Industrialasi-Ingineria-Mediului_PN-II-ID-PCE-2012-4-0398_qMI.html

BIOCATALYST-CLICK CHEMISTRY DOWNSTREAMING TANDEM BASED INNOVATIVE KIT FOR OPTICALLY PURE FINE CHEMICALS SYNTHESIS

Goal of the project:

The project main objective is to develop an innovative kit for efficient and cost-effective sequential continuous flow large-scale (multigram) preparation of optically pure chiral building blocks useful for synthesis of pharmaceutical compounds and agricultural chemicals, based on the tailor-made immobilized lipases mediated kinetic resolution of various racemic substrates and a subsequent click chemistry like efficient downstreaming of the reaction mixture. Such an innovative approach of coupling kinetic resolution of a broad range of racemic substrates with click chemistry type downstreaming was not yet carried out.

Short description of the project

Biocatalysis is an important tool to implement new, efficient, selective, cost effective and greener technologies, defining a new strategy in the industry of the future. For industrial applications, the stability and reusability of the biocatalysts are important requirements which can be achieved by immobilization, improving also their activity and selectivity. Optimization of the biocatalytic function, as well as the biocatalytic process design became essential topics in industrial biotechnology.

In this project a chemo-enzymatic process which integrates several innovative steps in both biocatalytic and down streaming parts will be set up. The utilization of tailor-made biocatalysts in industrial processes is an innovative approach, technically comparable to the synthetic solutions but with higher economic benefits. The use of immobilized biocatalysts-click chemistry tandem will permit to design easily scaled-up continuous flow procedures for industrial manufacturing of the target compounds, underlining the economic relevance of the proposal.

Project implemented by

- Politehnica University of Timișoara - Project leader
- University "Babes-Bolyai" Cluj Napoca - Partner 1
- Natural INGREDIENTS R&D S.R.L - Partner 2

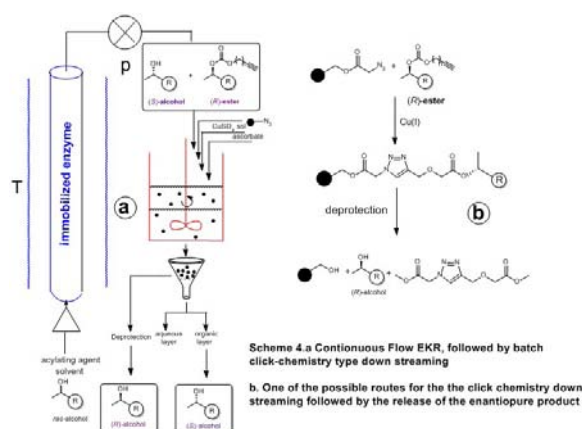

Implementation period

01.07.2014-30.06.2016

Main activities

1. Preparation of various precursors: (hetero)aryl-ethanols, hydroxy- and amino acids and synthesis of various propargylic esters as O- and N-acylating agents used in enzymatic kinetic resolution (EKR).
2. Development of optimal EKR and click-chemistry type downstreaming procedures.
3. Immobilization of lipases.
4. Development of the continuous flow procedure

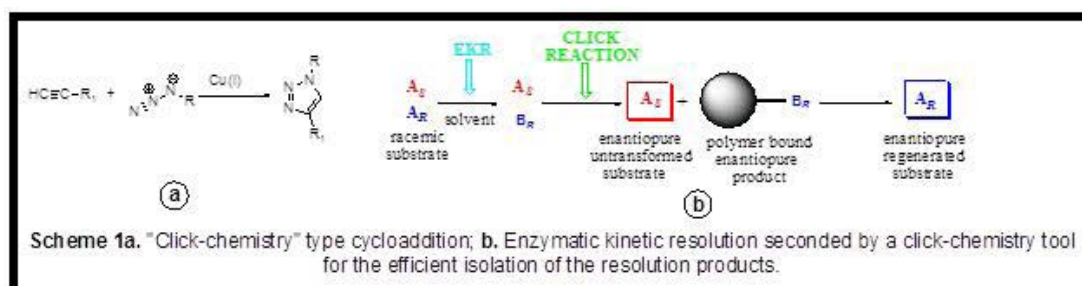

Results

1. Multi-gram amounts of various racemic compounds and various propargylic esters as acyl donors for the EKR;
2. Enantiomeric separation protocol for previously synthesized racemates, chromatographic protocols for testing the enantioselectivity of the enzymatic reactions;
3. Scientific article submitted to an ISI quoted journal;
4. Scientific presentation, published in the abstract book of an international conference;
5. Experimental protocol of down streaming procedures;
6. Immobilization protocols and analysis procedures for tailor-made immobilized lipases;
7. Integrated EKR-click-chemistry type down streaming procedure;

Applicability and transferability of the results

The obtained kit, as well as the high-value products, will be marketable, but the process will be appropriate for further scaling-up, depending on the customer demands.

In the forthcoming period, a strong impact of industrial biotechnology can be expected in the fine chemicals sector. As lipases demonstrated the highest application capability among industrial enzymes, the efforts to improve their operational stability and catalytic efficiency led to a remarkable development of the immobilization methods. Certainly, the manufacturing of high value optically active compounds represents the main large-scale process where biocatalysis with lipases will replace the presently employed procedures.

Enzymatic kinetic resolution (EKR) of the racemic mixtures represents the most efficient way to obtain high optical purity compounds. However, in large scale EKR an important challenge remains the isolation and purification of the products, which generally involves expensive and laborious physical procedures, decreasing the global process yields and the optical purities of the isolated compounds.



To the best of our knowledge the use of click chemistry involving large carriers, as a tool for easy EKR product separation is still unknown and it could be a practical solution for the efficient large scale isolation and purification of the enzymatic resolution products. Performing the click reaction between a preactivated polymer and one of the appropriate functionalized reaction products in the enzyme free reaction mixture obtained by EKR, would circumvent the tedious isolation and purification procedures.

Financed through/by

Executive Agency for Higher Education, Research, Development and Innovation Funding, UEFISCDI

Research team

Prof. Francisc Peter, PhD
Assist. Prof. Cristina Paul, PhD
Valentin Badea, PhD
Emese Biro Phd
Eng. Anamaria Todea
Eng. Adinela Cimporesu
Eng. Claudiu Marcu

Contact information

Prof. Francisc PETER, PhD
Department of Organic and Natural Compounds Engineering
Address: Carol Telbisz Street, No. 6, RO300001, Timisoara
Phone: (+40) 256 404216
Mobile: (+40) 745637530
E-mail: francisc.peter@upt.ro
Web: http://chim.upt.ro/Facultatea-de-Chimie-Industrial-a-si-Ingineria-Mediului_PN-II-PT-PCCA-2013-4-0734_qqpYW.html

DYNAMICAL SYSTEMS AND THEIR APPLICATIONS

Goal of the project

The main objective of this project is to create fundamental knowledge in dynamical systems theory and to apply this knowledge in formulating and analyzing real world models.

Short description of the project

The specific objectives, tasks and methodology of the project are contained in 5 WPs.

- In WP1 we develop new methods for the center and isochronicity problems for analytic and non-analytic systems, study bifurcations of limit cycles and critical periods.
- In WP2 we deal with the problem of integrability for some differential systems with invariant algebraic curves, study global attractors of almost periodic dynamical systems, Levitan/Bohr almost periodic motions of differential/difference equations.
- The main objective of WP3 is to study dynamics of some classes of continuous and discontinuous vector fields.
- WP4 deals with Hamiltonian systems in Plasma Physics, twist and non-twist area preserving maps, numerical methods, and the study of symmetries of certain kinds of k-cosymplectic Hamiltonians.
- The last WP tackles mathematical models in Neuroscience and Medicine.

Project implemented by

1. Politehnica University of Timisoara
2. West University of Timisoara
3. University of Craiova
4. Center for Applied Mathematics and Theoretical Physics, Slovenia
5. University of Maribor, Slovenia
6. Universitat Autònoma de Barcelona
7. Moldova State University
8. The Institute of Mathematics and Computer Science of the Academy of Sciences of Moldova
9. Tiraspol State University

Implementation period

01.10.2012 - 30.09.2016

Main activities

- Develop new methods and algorithms for studying center and isochronicity problems.
- Investigations of reaction-diffusion equations.
- Study of differential and integral operators of non-integer order.
- Study dynamics of certain classes of continuous and discontinuous vector fields.
- Study Hamiltonian systems with $1 \frac{1}{2}$ degrees of freedom and their discrete correspondents, namely systems generated by area-preserving maps.
- Investigations of ODE-based and map-based neuronal models.
- Study integrability for cubic differential systems

Financed through/by

FP7

Results

- M. Han, Valery G. Romanovski, Limit Cycle Bifurcations from a Nilpotent Focus or Center of Planar Systems, *Abstract and Applied Analysis*, Vol. 2012, Article ID 720830.
- Valery G. Romanovski, Y. Xia, X. Zhang, Varieties of local integrability of analytic differential systems and their applications, *J. Differential Equations* 257 (2014) 3079–3101.
- B. Fercec, J. Giné, M. Mencinger, Regilene Oliveira, The center problem for a 1:-4 resonant quadratic system, *J. Math. Anal. Appl.* 420 (2014) 1568–1591.
- J. Giné, C. Christopher, M. Presern, Valery G. Romanovski, and N. L. Shcheglova, The Resonant Center Problem for a 2:-3 Resonant Cubic Lotka–Volterra System, V.P. Gerdt et al. (Eds.): *CASC 2012*, LNCS 7442, pp. 129–142, 2012. Springer-Verlag Berlin Heidelberg 2012.
- Z. Hu, M. Han, V. G. Romanovski, Local integrability of a family of three-dimensional quadratic systems, *Physica D*, Vol. 265 (2013) 78–86.
- Z. Hu, M. Aldazharova, T. M. Aldibekov, V. G. Romanovski, Integrability of 3-dim polynomial systems with three invariant planes, *Nonlinear Dynamics*, 2013, 74(4), 1077-1092.
- D. Dolicanin, J. Giné, R. Oliveira, V. G. Romanovski, The center problem for a 2:-3 resonant cubic Lotka–Volterra system. *Applied Mathematics and Computation* Vol. 220 (2013) 12–19.
- G. Chang, T. Zhang, M. Han, On the number of limit cycles of a class of polynomial systems of Liénard type, *J. Math. Anal. Appl.* 408 (2013) 775–780.
- C. Liu, M. Han, The Number of Limit Cycles of a Polynomial System on the Plane, *Abstract and Applied Analysis*, Vo. 2013, Article ID 482850.
- G. Tigan, Analysis of a two-dimensional nonsmooth Poincaré-like map, *Nonlinear Dyn.*, 2014, 75(4), 643-651.
- M. Racila, *Recent Researches in Medicine, Biology and Bioscience*, pp. 39-44, 2013.
- Corina N. Babalic, Radu Constantinescu and Vladimir S. Gerdjikov, Two soliton solutions of Tzitzeica equation, *Physics AUC*, vol 23, 36-41, 2013.
- Corina N. Babalic, Adrian S. Carstea, On some new forms of lattice integrable equations, *Central European Journal of Physics*, 12(5), 341-347, 2014.
- J. Llibre, C. Valls. On the analytic integrability of the cored galactic Hamiltonian. *AM Lett.*, 33, 35–39, 2014.
- J. Llibre, D. Pasca, C. Valls. Periodic solutions of a galactic potential. *C,S&F*, 61, 38–43, 2014.
- F. E. Lembarki, J. Llibre. Periodic orbits for the generalized Yang–Mills Hamiltonian systems in dimension 6. *Nonlinear Dynam.*, 76, 1807–1819, 2014.

Research team

G. Tigan
 C. Lazureanu
 T. Binzar
 M. Stelian
 D. Constantinescu
 R. Constantinescu
 R. Militaru
 F. Munteanu
 M. Racila
 J. Llibre
 N. Vulpe
 D. Cheban
 A. Suba
 V. Romanovski
 D. Pagon
 D. Cozma
 V. Gromak
 A.p. Sadovskii
 V.v. Amelkin
 M. Han
 X. Zhang
 W. Zhang
 R. Oliveira
 M. Lima
 J. Cassiano

Contact information

Lect. Gheorghe TIGAN, PhD
 Department of Mathematics
 Address: P-ta Victoriei, No. 2, RO300006, Timisoara
 E-mail: gheorghe.tigan@upt.ro

RANDOM MATRIX TECHNIQUES IN QUANTUM INFORMATION THEORY (RMTQIT)

Goal of the project

The field of Quantum Information Theory (QIT) attracted lately the interest of scientific community due to its ambitious goals meant to create new technologic systems (quantum computers) and new more secured methods to transmit the information. Nowadays, QIT is a multi-faceted field, with large connections in the subfields of Mathematics, such as Functional Analysis, Operator Theory, Linear Algebra, Probability Theory. The project RMTQIT purposes to give answers to open questions from QIT, using techniques from random matrix theory.

Short description of the project

The project RMTQIT focuses on a systematic exploration of theoretical questions in QIT about random quantum states and random quantum channels. These problems have attracted the attention lately in a very naturally connection to fundamental issues of QIT theory, such as entanglement theory and classical (or quantum) capacities for channels.

Project implemented by

1. The Department of Mathematics, Politehnica University of Timișoara.
2. Laboratoire de Physique Théorique de Toulouse, Université Paul Sabatier Toulouse III, France.

Implementation period

01.03.2013 - 29.02.2016



Main activities

- In 2015 the project RMTQIT reached the third year of intensive research activities. It mainly focused on completing the tasks proposed initially, but also to expend the expertise developed along all these years of existence.
- It worth to mention that the team of the project published a joint paper with new results related to the derivation of thresholds points for reduction criterion and its absolutely version. This paper also succeeds to collect all the results about thresholds for entanglement criteria from similar papers, for making comparisons between the criteria and to give a complete picture of the subject under scrutiny. These results have been presented with several occasions at international conferences and workshops, such as Central European Workshop on Quantum Optics, Warsaw, 6-10 July 2015 (talk presented by M.A. Jivulescu), Quantum Thermodynamics and Quantum Information Theory, Toulouse, 9-11 September 2015 ((talk presented by M.A. Jivulescu)) and International Conference on Theory and Applications in Mathematics and Informatics, Alba-Iulia, 17-20 September 2015 (talk presented by N. Lupa).
- On November 2015 it took place the Workshop On the Mathematical Methods in Quantum Information Theory, workshop within the project RMTQIT, as satellite event of the 14th edition of International Conference in Mathematics and its Applications, organized by the Department of Mathematics, Politehnica University Timisoara. The workshop aimed to gather participants to discuss the latest themes in Quantum Information Theory, as well to establish new possible collaborations. We were happy to welcome here at Timisoara high-level scientists from well-know groups from Europe and to facilitate their interactions with the local research environment.

Results

The results of our research activity were resumed in the papers listed below:

1. Maria Anastasia Jivulescu, Nicolae Lupa, Ion Nechita-Thresholds for reduction-related entanglement criteria in quantum information theory, *Quantum Information and Computation*, Vol. 15, No 13&14, 2015, pp 1165-1184
2. Benoit Collins, Ion Nechita, Random matrix techniques in quantum information theory, (arXiv:1509.04689)
3. Maria Anastasia Jivulescu, Nicolae Lupa, Ion Nechita - On the reduction criterion for random quantum states - *JOURNAL OF MATHEMATICAL PHYSICS*, Vol. 55, Issue 11, Article Number: 112203-1-27, NOV 2014
4. Maria Anastasia Jivulescu, Pasc Gavruta-Indices of sharpness for Parseval frames, quantum effects and observables, submitted to *Buletinul Stiintific al Universitatii Politehnica Timisoara, seria Matematica -Fizica*, 2015
5. Laura Gavruta, Pasc Gavruta, Some properties of operator-valued frames, submitted to *Acta Mathematica Scientia*, 2015 (arXiv:1504.06504)
6. António J. G. Bento, Nicolae Lupa, Mihail Megan, César M. Silva - Integral conditions for nonuniform μ -dichotomy - arXiv:1405.2946
7. Maria Anastasia Jivulescu, Nicolae Lupa, Ion Nechita, David Reeb - Positive reduction from spectra -*LINEAR ALGEBRA and its APPLICATIONS*, Volume 469, NOV 2014, Pag. 276-304, doi:10.1016/j.laa.2014.11.031 (arXiv:1406.1277)
8. M.R. Abdollahpour, A. Najati, P. Gavruta - Multipliers of pg-Bessel sequences in Banach spaces - arXiv:1501.01146v1

Financed through/by

- Executive Agency for Higher Education, Research, Development and Innovation Funding (UEFISCDI)
- L'Agence Nationale de la Recherche (ANR), France

Research Team

Assist. Prof. Maria Anastasia Jivulescu

Dr. Ion Nechita

Prof. Găvrută Pașc

Assist. Dr. Nicolae Lupa

Contact information

Assist. Prof. Maria Anastasia JIVULESCU

Department of Mathematics

Address: Victoriei Square, no 2, RO300006, Timișoara

Phone: (+40) 256 403 098

Fax.: (+40) 256 403 109

Mobile: (+40) 740 517 340

E-mail: maria.jivulescu@upt.ro

Web: <https://sites.google.com/site/rmtqit2013/>

Projects supporting research

Field	Total number of projects presented	Source of financing	Number of projects by source of financing
Automation and Computers	3	Cross-border cooperation HU-RO* Cross-border Cooperation RO-SR* National Funds***	1 1 1
Electronics and Telecommunications Engineering	2	National Funds***	2
Mechanical Engineering	6	National Funds***	6
Engineering and Management	1	International Program**	1

* *Structural Funds - European Regional Development Fund, European Social Fund and the Romanian National Authority for Scientific Research,*

** *International Program - Leonardo da Vinci, Transfer of Innovation project (LDV-TOI)*

*** *Structural Funds - European Regional Development Fund, European Social Fund and the Romanian National Authority for Scientific Research (POSDRU)*

CROSS-BORDER ACCESS INFRASTRUCTURE TO HIGH-LEVEL EDUCATION THROUGH WEB-CASTS

Goal of the project

The overall goal of the project is to increase the overall competitiveness of the economy in the border area by creating a cross-border partnership between the Faculty of Automation and Computers from Timisoara and the Technical Faculty from Zrenjanin and by improving the quality of education for the students and pupils from the border area.

Short description of the project

The aim of this partnership is to implement an infrastructure for live and on-demand video streaming of learning material for the target groups and to this purpose establish a long and fruitful cooperation between teachers, pupils and students on both sides of the border.

The infrastructure is presented below:

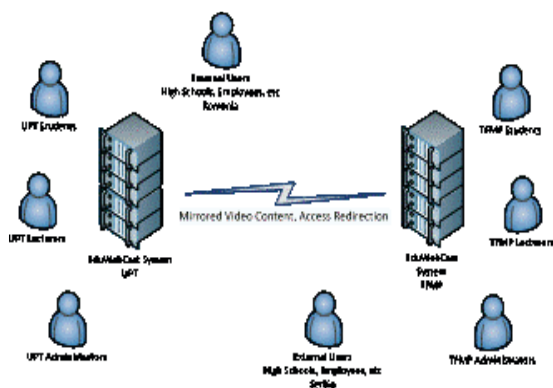

The joint realization and administration of the web cast project is the result of the partnership between the two faculties and will lead to more common projects based on the materials created through the project, contests between pupils and students, possible periodic educational exchanges.

Besides the students, the academic personnel will have the chance to contact their homologues on the other side of the border and exchange opinions, information and teaching techniques which will help improve the entire educational process in both partners to the benefit of the target groups.

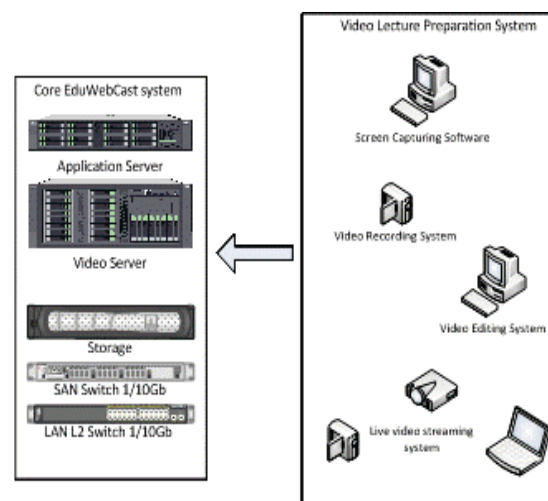

Project implemented by

- Politehnica University of Timișoara, UPT – Lead partner
- Technical Faculty "Mihajlo Pupin" Zrenjanin – Project partner

Implementation period

19.12.2013 - 18.06.2015

Main activities:

1. Communication and publicity activities;
2. Establishment of the hardware and software architecture;
3. Establishment of the content of the lectures;
4. Acquisition of the specific equipments and software.

Results

1. Several technical meetings took place both in Timișoara and Zrenjanin. As a consequence the architecture of the system was established both in the hardware and software parts.
2. The specifications were studied and both teams agreed on a list of equipment and on the features of the software.
3. The number of the lectures and their content were established.
4. After acquiring the foresight equipment, the common EduWebCast system was set up. The specific software, web pages and portal were designed and implemented.
5. The lectures were created, tested and uploaded on the EduWebCast system. They are accessible to the target groups.
6. Closing events were organized both in Zrenjanin and Timisoara.

Fields of interest:

Live and on-demand video

Applicability and transferability of the results:

- Achievement of a secure WiFi network covering a large area, offering also the EDUROAM service and IP streaming service
- Possibility to develop research oriented on IP streaming, network traffic and main features.

Research centre

Research Center in Computers and Information Technology

Financed through/by

Romania-Republic of Serbia IPA Cross-Border Cooperation Programme

Research team

Mircea Popa
Cristian Vașar
Octavian Proștean
Marius Marcu
Sebastian Fuicu
Răzvan Bogdan
Anca Sorana Popa
Versavia Ancușa

Contact information

Prof. Mircea POPA, PhD
Department of Computers
Adress: Blv. V. Pârvan, No. 2, R0300223 Timișoara
Phone: (+40) 256 403 003
Fax: (+40) 256 403 023
Email: mircea.popa@upt.ro

JOINT CROSS-BORDER INTERNET COMMUNICATION SYSTEM OF THE UNIVERSITY OF DEBRECEN AND POLITEHNICA UNIVERSITY OF TIMISOARA

Goal of the project

The overall goal of the project is to enable enhanced capacity for cross-country cooperation and interaction between and within the participating universities by providing high quality WiFi system and IP streaming system for the students, professors and researchers at the University of Debrecen and Politehnica University of Timisoara, aiming at supporting the synchronization of educational, research and development, and other scientific activities of the cooperating universities

Short description of the project

- Interior and exterior WiFi service will be installed at both sites to be able to access from mobile notebooks and smart phones the partners data and services infrastructure and Internet services.
- The project implements the EDUROAM service in PUT. This common authentication service with other universities within Europe allows accessing WiFi Internet, increases the Internet accessibility for both academic partners and incoming students travelling to PUT and UD.
- IP streaming subsystem will be installed at both universities to be able to interchange the local multimedia content between the partners.
- The activity during the year 2015 consisted in: improvement of the WiFi infrastructure for Quality of Service enhancement and extension of the WiFi network.

Project implemented by

- University of Debrecen, UD – Lead partner
- Politehnica University of Timișoara, UPT – Project partner

Implementation period

01.01.2013 – 31.05.2014 and
01.01.2015 – 31.08.2015.

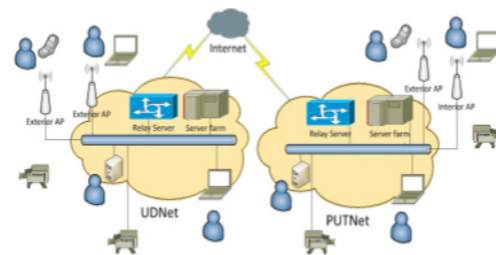

Main activities

- Communication and publicity activities;
- Acquisition of the specific equipments;
- Development and implementation of the specific WiFi network;
- Development and implementation of the specific IP streaming system.
- Extension of the WiFi network.

Results

- Several technical meetings took place both in Timișoara and Debrecen. As a consequence the inherently implementation problems were discussed and solved.
- The placement of the 200 Access Points covering the interior and exterior of the buildings of the faculties and student hostels from the campus was achieved and the connection to the specific infrastructure was done.
- The extension and improvement of the WiFi network was focused on one of the main buildings of UPT, belonging to the Faculty of Mechanics.
- The specific infrastructures for implementing the EDUROAM service and the IP streaming video service were developed and implemented.
- Tests were done and also the dissemination of the results was done.
- A closing event was organized.

Applicability and transferability of the results:

- Achievement of a secure WiFi network covering a large area, offering also the EDUROAM service and IP streaming service.
- Possibility to develop research oriented on IP streaming, network traffic and main features.

Fields of interest:

- WiFi networks, IP streaming

Research centre

Research Center in Computers and Information Technology

Financed through/by

Hungary-Romania Cross-Border Co-operation Programme
2007-2013

Research team

Mircea Popa
Marius Marcu
Sebastian Fuicu
Răzvan Bogdan
Oana Amaricăi-Boncalo
Sorin Julean
Marian Salavat
Mihaela Ciulean

Contact information

Prof. Mircea POPA, PhD
Department of Computers
Adress: Blv. V. Pârvan, No. 2, R0300223 Timișoara
Phone: (+40) 256 403 003
Fax: (+40) 256 403 023
Email: mircea.popa@upt.ro

SMART IT

Goal of the project

The overall objective of the project is to improve the process of insertion on the labour market of 150 students from the faculties of Automation and Computer Science and Civil Engineering Faculty, "Land Measurements and Cadastre" program. This improvement is realized by means of acquiring the necessary skills for integration and maintaining a modern, flexible and dynamic labour market, as well as the increase of the students' adaptability to the requirements of their first job in the domains of the specialties they are enrolled at

Short description of the project

Positive effects on the target group will be multiple and integrated into a set of measures that would maximize the employment potential of the persons belonging to the target group: on one hand, increasing the level and capacity for occupying a job through the stages of practice (minimum 500), enriching professional knowledge and skills, increasing the level of information of the persons from the target group and also the potential of local employers, to encourage employment, improve the capacity of learning, awareness of the necessity of studying and professional accumulation throughout life, and on the other side, last but not least, assistance and advice. Project activities which involve the use of innovative ICT tools facilitate access of the target group members to information and education and represent a horizontal competence, useful to any person in the target group (students).

Project implemented by

- Automation and Computers Faculty, Lecturer Codruta ISTIN, PhD
- Civil Engineering Faculty: Assoc. Prof. Sorin HERBAN, PhD

Implementation period

August 2015- December 2015



Main activities

- A1. Project management activities
- A2. It is a horizontal activity which will contribute to achieving all the specific objectives of the project.
- A3. Organizing and providing guidance and professional counselling services (5 months) for the target group to benefit from a complex and complete training for the insertion on the labour market. Members of this target group will participate not only to practice stages but also to information and professional counselling programmes, workshops and seminars.
- A4. Development and implementation of an informatic application for counselling, including batteries of tests.
- A5. Training of the users
- A6. Internships (practice stages)

Results

- A1: formation of a management team
- A.3: 1 orientation and counselling methodology, development of interest/skills surveys, workshops and exchange of best practices, active disseminated results and good practices concerning the transition from school to life
- A4. 1 functional counselling application, including batteries of tests completed
- A5. Results: minimum 150 trained and counselled students registered users within the application, minimum 3 conducted training sessions, , support materials for training seminars, completed batteries of tests for vocational counselling. Specific objectives supported by A5 are OS1, OS3 and OS5 A6. Practice partnerships signed, at least 150 students divided towards employers, at least 150 legal internships .

Applicability and transferability of the results

For the sustainability of the project's steps we have identified a number of sources that can substantiate the extension/multiplying of the results as well as their integration into public policies in education.



Financed through/by

European Funding Minister– POSDRU

Research Centre

Computers and Information Technology Research Centre
Research Centre for Construction and Transportation Substructures

Research Team

Lecturer Codruta Istin, PhD
Project manager/Responsible from Automation and Computers Faculty
Assoc.prof..Sorin Herban, PhD
Responsible from Civil Engineering Faculty

The team:

Horia Ciocârlie
Carmen Grecea
Cosmin Muşat
Alina Bala
Lucian Prodan
Ciprian Chirilă
Dan Pescaru
Daniela Stănescu
Razvan Cioarga
Flavius Pater

Contact information

Lecturer Codruta ISTIN, PhD
Assoc prof Sorin HERBAN, PhD
Faculties of Automation and Computer Science and
Civil Engineering Faculty
Land Measurement and Cadastre Program
Str. Piața Victoriei Nr. 2, Timisoara
Phone: (+40) 256 403285
Mobile: (+40) 757 100855
E-mail: codruta.istin@upt.ro;
sorin.herban@upt.ro

ORIENTATION OF STUDY PROGRAMS ON REGIONAL ECONOMIC REALITY, THEIR VALIDATION BY ECONOMICAL ACTORS AND THE DYNAMIC OF THE TRIPLE RELATIONSHIP UNIVERSITY – STUDENT – COMPANY FOR A PERFORMANT TECHNICAL HIGHER EDUCATION – OVDIP

Goal of the project

The overall objective aims at strengthening the capacity of higher education to support economic and social development. Strengthening the cooperation between universities and business environment – focusing on the innovation of the training regarding human resources with the adaptability/flexibility that it needs in a competitive economy. The increase of the higher education offer to the economic environment using the feedback from the important economic agents. The growth and the access to higher education by promoting programs that are supported by relevant companies for the economic development.

Short description of the project

- Six partnership models and a cooperation network including the university and economical agents.
- Studies and analyses developed to define a curricula taking into account the local economical needs of the companies. Entrepreneurial culture promotion among the students.
- A set of events that offer to the students relevant models of successful careers.
- Facilitation of access to higher education on an informed basis.

Project implemented by

- Politehnica University Timisoara
- Regional Consortium for Education and Employment West

Implementation period

14.05.2014 - 13.11.2015



Main activities

- A1. Developing, implementing and evaluating partnership models and a network containing the university and economical agents – including cooperation agreements and information transfers.
- A2. Conducting studies and analyses in order to define a curricula and a better connection to the market needs and the knowledge-based society.
- A3. Development, improvement and promotion of university programs that support entrepreneurial culture (as modules).
- A4. A set of activities developed such that to increase the access of high school graduates to higher education and a better correlation between higher education and the labor market (as events)
- A5. Project management.
- A6. Information and publicity.



Results

- A comprehensive study regarding the partnership model and the strengthened network.
- A set of twenty agreements signed as the network foundation for cooperation, including the set of working procedures that were previously agreed upon by network members.
- A set of 6 studies exploring programs related to relevant areas: Mechatronics and Robotics, Electronic Engineering and Telecommunications, Computer and Information Technology, Systems Engineering, Electrical Engineering, Automotives. A study contains the offer presentation, a comparative analysis regarding the needed skills required by the economic environment, with one set of recommendations at the syllabus, in order to correlate the offer to the demand.
- Six up to date study programs, with the validation of the actualization by the economic environment
- Five modules – as new learning opportunities – delivered to 170 participant students, each module taking place for two days, with feedback from students, analysis, conclusions and recommendations.
- Three events organized mainly for the students but also for the professors, having as guest alumni with outstanding professional careers and people with expertise and solid experience in linking education with labor market policies.
- An event in the form of a conference conceived to promote the higher education offer and to acknowledge outstanding performance of young candidates for higher education, with regional participation, encouraging further studies in areas relevant to the local economy.
- Launching conference, intermediate conference and final conference.

Applicability and transferability of the results:

- Increasing the cooperation between the university and the economic environment in an institutional framework aiming distinct areas of cooperation, updating curricula in accordance with the economic realities of the local area, alternative learning options in the entrepreneurship domain, promoting and informed opting of high-school graduates for the technical university domain.
- Adoption by the university of new mechanisms and management techniques resulted from the projects activities to be functional, relevant and necessary.



Financed through/by

Sectoral Operational Programme for Human Resources Development (POSDRU) – ID 136302.

Research team

Mihai Muțiu	Marius Minea	Aurel-Viorel Șerban
Aurel Gontean	Mircea Strugaru	Marius Oteșteanu
Ioan Lie	Valentin Mureșan	Daniel Dan
Doina Mortoiu	Ioan Silea	Mircea Popa
Valer Dolga	Bogdan Groza	Ivan Bogdanov
Erwin Lovasz	Sebastian Nicoară	Horia Ciocârlie
Ovidiu Ciurdar	Ciprian Todea	Nicolae Mușuroi
Alin Drăgan	Dorina ISAR	Inocențiu Maniu
Ioan Laza	Cătălin Căleanu	Gheorghe Cocian
Liviu Mihon	Florin Berinde	Silviu Doboși
Florin Dărac	Virgil Ivșescu	Teodor Todincă
Teodor Hebrîștean	Ciprian Dughir	Nicolae Groșan
Alexandru Hedeș	Marius Foica	Alina Zamoșteanu
Alin Argeșanu	Vlad Stanciu	Liliana Mățiu
Sever Scridon	Petru Demian	Alina Dumitrel
Marian Coroiu	Ciprian Angheluță	Adina Palea
Ioana Șora	Marian Apostol	Dan Lascu

Contact information

Prof. Dan Lascu, PhD
 Department of Applied Electronics
 Address: Vasile Pârvan Boulevard, no. 2, RO 300223, Timișoara
 Phone: (+40) 256 403 343
 Mobile: +40723197219
 E-mail: dan.lascu@upt.ro

INTER-UNIVERSITY PARTNERSHIP FOR EXCELLENCE IN ENGINEERING - PARTING

Goal of the project

1. Improvement and stimulation of participation to doctoral programs.
2. Attracting potential researches to pursue a career in research for stimulating economic growth and development of knowledge-based society.
3. Improvement of mobility during doctoral studies.
4. Promoting interdisciplinarity in engineering
5. Enhancing adaptability in a continuously changing scientific and economic environment

Short description of the project

- 25 scholarship grants awarded to 25 doctoral students for 18 months
- Domains:
 1. Information Technology;
 2. Electronics and Telecommunications;
 3. Systems Engineering;
 4. Power Systems and Energy;
 5. Environmental Sciences; A
 6. rchitecture;
 7. Materials Science;
 8. Mechanical and Industrial Engineering;
 9. Management.

Project implemented by

- Technical University of Cluj-Napoca - coordinator
- Politehnica University of Timisoara - partner
- Transilvania University of Brasov - partner

Implementation period

01.01.2014 - 31.06.2015

Main activities

- Scholarship grants for 25 doctoral students
- Financial assistance for long term mobility (more than one month) in EU universities
- Financial assistance for publications and participation to scientific conferences

Results

- Increase of number of PHD theses sustained
- Increase of number of published papers
- Improvement of quality of doctoral programs through interdisciplinarity

Applicability and transferability of the results

Trans-national and inter-regional development

Financed through/by

Operational Sectorial program for Development of Human Resources - POSDRU 2007-2013

Priority Axis: 1. Education and Professional Formation for Supporting Economic Growth and Development of Knowledge-Based Society
Intervention Domain: 1.5 Doctoral and Post-Doctoral Programs for Supporting Research

Research team

Prof. Aldo De Sabata, PhD

Contact information

Prof. Aldo De SABATA, PhD
Department of Measurement and Optical Electronics
Address: Bd. Vasile Pârvan, No. 1, RO300223, Timisoara
Phone/Fax.: (+40) 256 403 370
E-mail: aldo.de-sabata@upt.ro

DOCTORAL AND POSTDOCTORAL SCHOLARSHIPS FOR RESEARCH EXCELLENCE

Goal of the project

The main goal of the project is the strengthening of a competitive framework for the financial support of Ph. D. students and postdoctoral researchers in order to enhance their education. The project provides also a large transnational cooperation between universities, research centres and companies.

Short description of the project

- Facilitation and improvement of the researchers' experience in priority research areas;
- Enhancement the access to research infrastructure in cooperation with universities and renowned research centres in UE;
- Improvement the value of research at both doctoral and postdoctoral level by increasing the number of researchers and the number of priority research topics;
- Providing of funds in support of research activities for twenty Ph.D. students and five postdoctoral researchers of our university;
- Increasing the visibility of research outcome by publishing the results in prestigious journals and conference proceedings.

Project implemented by

1. Transilvania University of Brasov
2. Politehnica University of Timisoara
3. Technical University of Cluj-Napoca
4. Universidade Nova de Lisboa (Portugal)
5. Université de Technologie de Belfort-Montbéliard (Franta)

Implementation period

15.04.2014 – 14. 10. 2015

Main activities

1. Development of a framework for selecting the target group of researchers to be financed, based on a powerful competition;
2. Financial support for the selected researchers:
 - Monthly stipend of 1800 lei for doctoral students and 3700 lei for postdoctoral researcher,
 - Research fellowship within UE universities of 4200 lei/ month for doctoral researchers,
 - Travel grants for a research stage abroad of 1000 lei,
 - Cover of costs for travel and accommodation in view of participating to scientific events until 1000 lei and 600 lei respectively,
 - Subscriptions/ purchases of scientific publications (2200 lei),
 - Consumables until 2200 lei,
 - Acquisition of a laptop (3000 lei).
3. Tutoring and scientific guidance for researchers;
4. Dissemination of results within seminars and training sessions.

Results

- 25 researchers from UPT were selected (20 Ph.D. students and 5 postdoctoral researchers);
- Financial support for 25 researchers;
- 3 articles published by researchers members of the UPT target group in several international journals;
- 15 published research papers under the signature of the UPT researchers in the proceedings of various international conferences;
- 9 research papers to be published in the proceedings of several international conferences, by UPT researchers.

Applicability and transferability of the results

An up to date management for doctoral and postdoctoral research is a compulsory requirement for any university that aims to be part of teh European Research Area.

Doctoral studies are studies of higher education of elite and allow the attainment of qualifications of 8th level, according to the European Qualifications Framework (EQF) and National Qualifications Framework (NQF).

Financed through/by

The European Social Fund, Sectoral Operational Programme Human Resources Development - POSDRU

Research team

Prof. Valer Dolga, PhD
Prof. Arjana Davidescu, PhD
Prof. Anca Drăghici PhD
Prof. Lacrimioara Stoicu-Tivadar, PhD
Prof. Francisc Peter, PhD
Prof. George Savii, PhD

Contact information

Prof. Valer DOLGA, PhD
Department of Mechatronics
Address: Bv. Mihai Viteazu, No. 1, RO300222, Timișoara
Phone: (+ 40) 256 403 554 / (+ 40) 256 403 544
E-mail: valer.dolga@upt.ro

PARTNERSHIP DEVELOPED FOR COUNSELINGS AND STUDENTS PRACTICE IN ORDER TO INCREASE THEIR EMPLOYABILITY – CONPRACTIS

Goal of the project

Project main objective is developing practical knowledge for 180 students, future high degree graduates, through optimizing practice stages for better insertion of students inside labor market, in context of knowledge based society, with a strong globalization phenomenon together with transforming forces at society level.

Short description of the project

Through the project are followed:

- Creation and development of durable partnerships between university and a minimum of 20 companies (activity A3).
- Programs quality improvement for student practical development and information campaigns regarding the opportunities inside this type of programs (activities A3 and A4). This objective is measured through information campaign for 250 students and a minimum of 25 closed partnerships.
- Specific practical skills training for 180 students of various majors through the effective deployment of practical programs (activity A3).
- Employability skills training (interdisciplinary skills) for increasing employability in the labor market for 210 students (activity A2).

Project implemented by

- Politehnica University from Timișoara
- "Aurel Vlaicu" University from Arad
- S.C. MASCHNINENTECHNICH IMPEX S.R.L.

Implementation period

28.08.2015-28.12.2015



Main activities

- A1. Project management
- A2. Counseling and professional orientation activity
- A3. Student practice activity as stage inside their career development
- A4. Project dissemination and visibility activity

Results

Assumed results through grant application are:

- 210 counseled students in their career through rote counseling
- A minimum of 20 partnership agreements with practice partner companies
- 180 students in practice at economic companies, practice partners
- 500 informed students regarding project opportunities
- 55% from target group students will be involved in further competitions or will get hired.

Applicability and transferability of the results:

- The activities developed within the project by material created to ensure the chance that both practice model (existing), and the model of career counseling (proposed by this project) to be taken over by other projects of this kind implemented at UPT or other beneficiaries.
- The methodology for organizing and conducting practical activities proposed and developed in this project is long-term used in collaboration with universities / companies in order to align students' practical training to labor market needs.
- All activities are aimed at increasing the quality of practical training and preparing students for a future job.
- Through the web-site which will be constantly updated it will be ensured the project results dissemination and multiplication of best practices used by other entities interested in the field covered by this project.



Research centre

Mechanical Machines Equipment and Transportation

Financed through/by

European Social Fund
Operational Sectorial Program for Human Resources Development
2007-2013
Priority axis 2 „Lifelong learning correlation with labor market”
Major domain of intervention 2.1. „Transition form school to active life”
Contract code POSDRU/189/2.1/G/156607

Research team

Luisa Izabel Dungan
Lavinia Maria Cernescu
Ion Vetreş
Sorin Deaconu
Nicolae Lontiş

Contact information

S.I. Luisa Izabel DUNGAN, PhD
Departament: Mechanical Machines Equipment and Transportation
Address: Bv. Mihai Viteazu, No.1 Postal Code 300222, Timisoara
Phone: (+40) 256 403723
Mobile: 0724230340
E-mail: luisa.dungan@upt.ro
Web: www.conpractis.ro

ACTIV ON THE LABOR MARKET: TECHNICAL ABILITIES AND COMPETENCES FOR INTEGRATION AND VALORIZATION ON LABOUR MARKET

Goal of the project

- Improving the employment capacity for 1,000 persons, especially unemployed young people and long term unemployed, through the development and certification of skills and vocational skills required by the labor market in the domain of information technology and communications by the use of integrated programs for information, advice, training and mediation;
- Contributing to achieving the objective of harmonization undertaken professional skills of people from the target groups, almost in regions with labor market demands deployment of IT&C, providing increased employment opportunities for them to enter in the labor market as active people.

Short description of the project

- The project includes specific activities as: periodical meeting of project management team, dynamic work procedures, continuous monitoring according and respecting the financing contract, as, also procurement of good end services. Different IT&C courses, in 7 topics, for 910 persons, were organized.
- Information and publicity is insured by two conferences (launching and closing of the project), press releases, contractig of different mass-media ways for disseminate in different media campaigns and web page of the project.

Project implemented by

- Universitatea Politehnica din București;
- Universitatea Politehnica Timisoara;
- Universitatea Tehnică "Gheorghe Asachi" din Iași;
- Universitatea "Petru Maior" din Tîrgu Mureș;
- Pythia INTERNATIONAL S.R.L. BUCUREȘTI;
- Institutul pentru Politici Sociale București

Implementation period

01.04.2014 – 31.12.2015



Main activities

1. Procurement of goods and services;
2. Project management;
3. Information and publicity, promoting of results;
4. Organizing of different IT&C courses for 910 persons in 7 topics;
5. Developing of full open service system for mediation on labor market, designated at 250 persons;
6. Web-browsing;
7. Compile a report/book towards the end of the project.

Results

- 2 conferences for promoting of the project;
- 4 mass-media campaigns for promoting of the project; (Journals, radio, online, indoor), flyers, etc.;
- web page interactive of the project;
- 750 persons, selected, informed and orientated professional;
- 500 portfolio, realized and posted online;
- 90 course sessions;
- 120 persons employed in 6 months;
- 910 qualified persons
- 5 Fair jobs,

Applicability and transferability of the results:

- Improving of competences and profesional habilities will contribute at increasing the acces to employment opportunities in a topic which, till now, already generated economic improvement, even during crisis.

The project will generate on long time next positive effects:

- Increasing of the number of persons supported by information and guidance for find a work place;
- Increasing the number of persons which have up-to-date qualification, contributing at developing of human capital and development of competitiveness market.



Research centre

Mechanical Machines Equipment and Transportation



Financed through/by

European Social Fund
Operational Sectorial Program for Human Resources Development
2007-2013
Contract code POSDRU/125/5.1/S/125723

Research team

Ilare Bordeasu
Viorel Aurel Șerban
Carmen Opreș
Octavian-Petru Proștean
Sorin Ioan Deaconu
Ion-Dragoș Uțu
Dumitru Țucu
Sorin-Nicolae Nanu
Mihaela Popa
Rodica Bădărău
Sebastian-Titus Duma
Vasile-George Cioată
Corina Daniela Cunțan
Corina-Maria Diniș
Imre-Zsolt Miklos
Manuela Pănoiu
Iosif Szeidert-Subert
Vașar Cristian
Ionel Muscalagiu
Constantin Florescu
Mircea Dorin Vasilescu

Contact information

Prof. Ilare BORDEASU, PhD
Department for Mechanical Machines, Equipment and Transportation
Address: Bd. Mihai Viteazul, No.1, RO300222, Timisoara
Phone: (+40) 256 403 591;
Mobile: (+40)723650248
E-mail: ilare.bordeasu@upt.ro
Web:<http://specialistactiv.ro/documente/prezentarea-proiectului.pdf>

ENGINEERING FOR ELI-NP MAINTENANCE”

Goal of the project

Developing a curriculum for master’s programs through the creation of optional innovative and flexible modules, better adapted to the needs of the labor market and society, according to current regulations, engineering Laser – “Light Amplified by Stimulated Emissions of Radiation” and ensuring the protection and maintenance of the ELI-NP predictive infrastructure.

Short description of the project

The activities carried out are focusing on:

- Assuring of a significant contribution to the advancement of the entire society;
- Providing for graduates of specific skills related to how treatment products activated by exposure to very high power laser radiation simultaneously or with exposure to the action of high energy gamma radiation;
- Familiarize students from various faculties of nano-materials and nanotechnologies technically embedded in the facilities construction ELI-NP;
- Ensuring continuity in the flow of graduates of master cycle following top form doctoral training in the use and maintenance of very high power laser facilities;
- Improving access and expanding learning opportunities for graduates of undergraduate, masters by providing flexible, tailored to labor market requirements.

Project implemented by

- Politehnica University of Timisoara, Partner
- Universitatea Politehnica București, Coordinator
- Institutul Național de Cercetare - Dezvoltare pentru Fizică și Inginerie Nucleară „Horia Hulubei”, IFIN-HH, Partner
- Universitatea de Medicină și Farmacie “Carol Davila” București, Partner
- Universitatea din Craiova, Partner
- Universitatea Tehnică “Gheorghe Asachi” Iași, Partner

Implementation period

14.05.2014 - 14.12.2015.

Main activities

Project steps:

- measurements in situ / phase,
- results processing,
- data interpretation
- reparation of analysis bulletin/report

Results

- studies - 6;
- curriculum developed - 6;
- workshops - 6;
- seminars - 13;
- visits for the target group - 7;
- students beneficiary from operations financed at higher education institutions – 280, from which 35 from UPT
- Events “Days of promoting laser installations” - 7.



Project presentation achieved by the UPT team in order to recruit the students for the target group, January 2014

Applicability and transferability of the results:

- Developing of a training course/master course/ for preparing young experts in ELI infrastructure (multiple fields)
- The project presented a clear public interest, had an important role in training (present and future) specialists familiar with the particular facility Extreme Light Infrastructure, in order to have the necessary powers to carry out related activities and also has a role in boosting the national economy by allowing entities initiating start-ups and spin-off to be developed around this infrastructure.

Research centre

Research Centre for Thermal Machines and Equipments, Transportation and Environmental Pollution Control



UPT students of the target group visiting the ELI platform from Magurele, March 2015

Financed through/by

Sectoral Operational Program Human Resources Development, 2007-2013



UPT students of the target group visiting the ELI platform from Magurele, March 2015

Research team

Ioana Ionel (Partner coordinator)
Dan Stepan
Nicolina Pop (voluntary)
Simona Filipaş (voluntary)

Contact information

Prof. Ioana IONEL, PhD
Department for Mechanical Machines, Equipment and Transportation
Address: Bd. Mihai Viteazul, No.1, RO300222, Timisoara
Phone: (+40) 256 403670
Mobile: 0723 349337
E-mail: ioana.ionel@upt.ro
Web: <http://www.imenteli.upb.ro/>

REGIONAL PARTNERSHIP FOR THE TRANSITION TO THE LABOR MARKET THROUGH CAREER COUNSELING AND INTERNSHIPS AT EMPLOYERS-PRACTICOR® EURO-REGIO

Goal of the project

Supporting of Equal opportunities, Sustainable Development, Innovation and ICT, Active aging and, Transnational approach for sustaining the preparation of students in order to access more successfully the present needs of the labor market and get a technical and financial support for professional orientation and development of practical abilities.

Short description of the project

Application of an innovative tool for developing an engineer as the society needs it by an original tutorial model of practice addressed to students from technical universities to

- increase their performance and quality of training (bachelor and master students), and
- open for them multinational and interdisciplinary perspectives.

Getting into contact with real economic units, starting already from bachelor position, enhancing thus the chance for the students to be prepared for the labor market.

The practical work directly related to economic units is fully completing the information that the student receives as a graduate, and support the developing specific, practice oriented capabilities and knowledge.

Project implemented by

- UPT as Coordinator
- University "Eftimie Murgu" Resita,
- University Szeged (Hungary, Szegedi Tudományegyetem), and
- The Institute for Studies and Energetic Design ISPE București.

Implementation period

30.04.2014 - 29.10.2015

Main activities

1. Project management
2. Exchange of experience and dissemination of best practice on practical training of students
3. Developing, implementing and evaluating the offer career counseling for students in developing careers as stage
4. The organization, implementation and evaluation of student internships and stages for the career development
5. Information, dissemination and communication of activities and results



Results

- Number of students supported in the transition from school to active life (by practical training): 256 achieved from a total of 240 planned
- The number of beneficiaries of career counseling services: 559 achieved from a total of 360 planned
- Editing of four Technical Bulletin for presenting the research results of the students
- Lucrative framework of more than 27 practice partners (representing economic state and private companies) offering internship or practical positions for the students, by means of their tutors.
- Framework of tutors by accrediting and offering a free of charge course achieved by the UPT specialists towards the economic units representatives.



Applicability and transferability of the results:

- Developing and application of a model (registered at OSIM as registered trademark) for practice (and all activities in connection to student activities, including research, developing of publications, etc) as securing basics to professional success of young engineers, and its real need;
- Working methods and procedures as experienced in the frame of the created network;
- Basic Materials (portal interactive work, room and multipurpose network of vocational guidance, and Specialist staff (tutors, experts, etc.);
- Without this practical base, there is less chance to shorten the time in which a student achieved to chose a suitable profession is according to his capabilities, life plans and opportunities;
- The project is a proof that strategies at UPT are bend towards this practical training, being aware of the necessity and obligation;
- The management capacity of teachers dedicated to support in a sustainable manner the educational process, mainly the practical training of students .

Research centre

Research Centre for Thermal Machines and Equipments, Transportation and Environmental Pollution Control

Financed through/by

Sectoral Operational Program Human Resources Development, 2007-2013



Research team

Ioana Ionel
Mircea Vasilescu
Dana Lenuta Hudac
Ioan Groza
Ramon Balogh
Liliana Tulcan
Adelina Han
Dan Stepan
Iris Mihai
Andrei Craciun
Simina Iliuta Darabant
Alina Monica Atanasescu
Georgeta Emilia Mocuta
Gabriela Nagy
Simona Tripon

Contact information

Prof. Ioana IONEL, PhD
Department for Mechanical Machines, Equipment and Transportation
Address: Bd. Mihai Viteazul, No.1, RO300222, Timisoara
Phone: (+40) 256 403670
Mobile: 0723 349337
E-mail: ioana.ionel@upt.ro
Web: www.practicor.ro/euro-regio

ACTIVE INSERTION ON THE LABOR MARKET THROUGH INNOVATIVE TRAINING IN ENGINEERING – FORMING

Goal of the project

The project's goal is the employability improving for the unemployed and people looking for a job, by providing integrated services and innovative counseling, mediation and customized engineering training in order to improve skills and professional competencies and a greater correlation of them with the labor market needs in the North-East, West, Central, South-Muntenia and Bucharest-Ilfov Regions.

Short description of the project

• The project addresses to graduate people of secondary and higher technical education studies that fits into one of the following categories: unemployed, long-term unemployed, people searching for a job (never been employed) or inactive people.

Project implemented by

- Politehnica University of Bucharest
- Politehnica University of Timisoara
- "Lucian Blaga" University of Sibiu
- Technical University "Gheorghe Asachi" of Iași
- The Red Point SA
- S.C. Ascendo S.R.L.

Implementation period

01.04.2014 – 30.09.2015

Main activities

- A1. Project Management
- A2. Information, communication and advertising activities develop to support the attending of project objectives and indicators
- A3. Providing information and professional counseling services for individuals and groups of people (included in the target group)
- A4. Providing mediation services, including individual mediation plans development and job shops organization

- A5. Providing training programs (through techniques and modern methods using a ICT) and professional development
- A5.1. Developing, implementing and maintaining the ICT platform that will integrate applications required in the project
- A5.2. Designing and developing of the on-line and onsite courses (training support) as well as providing professional training services

Results

The expected results/indicators at the national level are:

1. 1000 people informed and beneficiaries of the professional orientation services
2. 400 people, beneficiaries of the mediation services
3. 960 persons selected for being participants in the professional training program (courses)
4. Minimum 100 information actions on project activities
5. Organization of 4 job shops
6. 288 long time unemployed people participants in integrated programs, out of which: 136 women, 74 young people, and 78 people having more than 45 years old
7. 61% of the integrated programs participants should be certified
8. 13% of the integrated programs participants should be employed in the next six months (from the end of the project)



Proiect cofinanțat din Fondul Social European prin Programul Operațional Sectorial pentru Dezvoltarea Resurselor Umane 2007 – 2013

Insertie activă pe piața muncii prin formare profesională inovativă în domeniul ingineriei - FORMing

Applicability and transferability of the results

Long-term positive effects of the project are:

- Human capital development in accordance with the requirements of a highly competitive labor market in the engineering field;
- Fostering integration and reintegration into the labor market of the unemployed with secondary or higher technical education, from rural and urban areas by providing individualized training programs and in accordance with market requirements. These will contribute to the increasing of the employment rate.
- Stimulation of the (re)integration into the labor market of the people from the regional target groups by providing them real opportunities on finding and getting a job in the field of engineering; these will contribute to the employment rate increasing on the labor market, in accordance with vision of the general objective of the Programme.



Research centre

- Integrated Engineering Research Center (CCII)
- Materials and Manufacturing Engineering Department (IMF)

Research team

Prof. George-Emilian Drăghici, PhD
Assoc. Prof. Cristian-Gheorghe Turc, PhD
Assoc. Prof. Eugen Pământaş, PhD
Assoc. Prof. Mircea Nicoară, PhD
Lecturer Felicia Veronica Banciu, PhD
Lecturer Adrian But, PhD

Financed through/by

EUROPEAN SOCIAL FUND

Sectoral Operational Programme Human Resources Development
2007 – 2013

Priority: 5. Promoting active employment measures

Key Area of Intervention: 5.1. Developing and implementing active
employment measures

Cod Contract: POSDRU/125/5.1/S/134003

Contact information

Prof. George DRĂGHICI, PhD
Department of Materials and Manufacturing Engineering
Address: Bv. Mihai Viteazu, No.1, RO300222, Timisoara
Phone: (+40) 256 403 610
Mobile: (+40) 740 348 430
E-mail: george.draghici@upt.ro
Web: http://www.eng.upt.ro/imf/ccii/index_en.html

LEADSUS LEADERSHIP IN SUSTAINABILITY – SUSTAINABILITY MANAGER

Goal of the project

The general objective is to transfer and integrate a new skill at the level of European industry and institutions. Specific objectives of the LeadSUS project are:

1. Adaptation, harmonization and refinement of existing training materials and their integration into a professional training program dedicated to employees of companies, institutions and VET organizations;
2. Achievement of EU Certification of the new training program and job role as Sustainability Manager within the ECQA framework;
3. Creation of E-learning platform within the ECQA to facilitate the on-line training on sustainability management for different trainees from different EU locations;
4. Extension of Capability Adviser - Process Management Software Tool to support Sustainability Management assessment methodology;
5. Testing/piloting the training program in Romania and France;
6. Building the capacity in Sustainability Management topics in Romania, Slovenia and France by training of future trainers (15 persons) and future Sustainability Managers (110 persons).

Short description of the project

Activities and details about the LeadSUS project are available on the project web page: www.leadsus.eu

The project activities and results will support organizational leaders and employees, to understand the strategic implications of sustainability by developing innovative and creative approaches.

LeadSUS training program will drive leadership understanding, strategic business approaches, enthusiasm, innovation and consideration of environment and social aspects as key issues toward sustainable development. The training program is developed by the project consortium members and it will be available on-line as multimedia training materials with exercises, case studies and references (in English and Romanian languages), but also, in a printed book that will be a guide for sustainable managers.

LeadSUS training program develops competences and skills on the following topics:

- Sustainability management,
- Economic sustainability,
- Ecologic sustainability,
- Social sustainability,
- Product sustainability.

LeadSUS training program is developed in accordance with the ECQA (European Certification and Qualification Association) guidelines (www.ecqa.org). All participating trainees will have the opportunity to certify their newly acquired skills and competences within ECQA framework, on two performance levels: foundation or advanced.

LeadSUS training and certification platform will be available on www.ecqa.org

The project target group consists of managers and employees, representatives of private organizations (industry related) and public organizations, with environmental, social or business development related responsibilities and employed master students.

Project implemented by



DSRO – SC DENKSTATT ROMANIA SRL, Timisoara, Romania www.denkstatt.ro



UPT – Politehnica University of Timisoara, Romania www.upt.ro



INPG – Institut Polytechnique de Grenoble, France www.grenoble-inpg.fr



BICERO – BICERO, Business Informatics Center Rozman Ltd., Slovenia www.bicero.com



EMIRacle – European Manufacturing and Innovation Research Association, Brussels, Belgium (www.emiracle.eu)



ISCN – International Software Consulting Network I.S.C.N. GesmbH, Graz, Austria www.iscn.com

Implementation period

18.11.2013 – 18.11.2015



Main activities

LeadSUS project activities are described by the following work packages (WP):

WP 1 - Project management

- 1.1. Project coordination and collaboration
- 1.2. Project Administration and reporting

WP2 - Project Quality management

- 2.1. Project quality and evaluation criteria
- 2.2. Configuration management and Project Document Control
- 2.3. Quality reviews

WP3 - Identification of market needs and skill set design

- 3.1. Identification of target group and their needs
- 3.2. Identification of innovative methods, tools standards and techniques to satisfy the target group needs
- 3.3. Identification of similar training programs
- 3.4. Certified Sustainability Manager Skills set design

WP4 - LeadSUS - Sustainable Manager training material package adaptation and refinement

- 4.1. Adaptation and refinement of existing training materials and adapting to the skill set and material translation into EN, SI, FR and RO languages
- 4.2. Multimedia materials
- 4.3. Development and extension of Process management tool with Sustainability section
- 4.4. Development of Leadership in Sustainability Guide

WP5 - ECQA E learning platform configuration

- 5.1. Prepare and configure the On line learning management system and self assessment portal
- 5.2. Prepare On line course based on the training material

WP6 - Examination and Certification within ECQA framework

- 6.1. ECQA Exam Question Database
- 6.2. Certified Sustainability Manager Job role Committee

WP7 - Dissemination and exploitations of results

- 7.1. Dissemination and exploitation plan, micro planning
- 7.2. Dissemination activities and records
- 7.3. Final event of the project
- 7.4. Leadership in Sustainability Guide publishing and distribution

WP8 - Transfer of knowledge to Slovenia, France and Romania

- 8.1. Pilot training in Grenoble
- 8.2. Pilot training in Timisoara
- 8.3. Train the trainers in Timisoara
- 8.4. Train the trainers in France
- 8.5. LeadSUS - Sustainability Manager training for company and institutions trainees in Timisoara/Romania
- 8.6. LeadSUS - Sustainability Manager training for company and institutions trainees in Bucharest/Romania
- 8.7. LeadSUS - Sustainability Manager training for company and institutions trainees in France
- 8.8. LeadSUS - Sustainability Manager training for company and institutions trainees in Slovenia

Results

The main result of the LeadSUS project will be a complete defined training and certification program called: Leadership in sustainability – Sustainability Manager. The training materials (in English, Romanian, French and Slovenian languages) will be available on-line on a designed web platform (ECQA e-learning platform) and the certification program will be supported by the European Certification and Qualification Association (www.ecqa.org).

Applicability and transferability of the results

The consortium's vision is to create a great impact in Romanian, Slovenian and French companies and in-stitutions. One Sustainability Manager can shift an entire company in the direction of sustainable development. Leading Sustainability is a key issue in companies and institutions. One professional Trainer in Sustainability Management will impact companies and institutions on a long term, providing capacity building for future Sustainability Managers.

LearSUS project will have impact in 3 countries (Romania, Slovenia, France) and 4 related regions (Western and Bucharest-Ilfov Regions in Romania, North-Eastern Slovenia, South – Eastern France).

LeadSUS training program will be transfer and assimilated with a master or post-graduate program developed by UPT. In additional, project pool knowledge will be transfer in some PhD and post-doctoral research programs.

There is planned a long term impact of the LeadSUS project in the EU wide, by creation of a new ECQA Certified Job Role (www.ecqa.org) in a new profession, available for EU citizens and more.

Financed through/by

European Commission, Educational, Audiovisual & Culture Executive Agency

LIFELONG LEARNING PROGRAMME, through the National Agency in Romania (www.anpcdefp.ro)

A Leonardo da Vinci, Transfer of Innovation project (LDV-TOI)

Research team

Prof. Anca Draghici, PhD

Prof. Gabriela Proștean, PhD

Prof. George Drăghici, PhD

Prof. George Gustav Savii, PhD

Prof. Georgeta Ciobanu, PhD

Assist. Prof. Sorin Suci

Assoc. Prof. Claudiu Albulescu

Assist. prof. Caius Luminos

Contact information

Prof. Anca DRAGHICI, PhD

Department of Management

Address: Remus Str., No. 14, 3RO00191, Timisoara

Phone: (+40) 256 403 610

E-mail: anca.draghici@upt.ro

Web: <http://leadsus.bicero.com/>

Projects supported by private funds

Field	Total number of projects	Number of projects presented
Systems Engineering & Computers and Information Technology	9	-
Electrical and Power Engineering	6	4
Electronic Engineering and Telecommunications	3	-
Civil Engineering and Building Services	17	4
Mechanical Engineering	62	3
Engineering and Management	8	2
Chemical Engineering	10	3
Mathematics	1	1

*NOTE: For presentation we have chosen the most relevant projects for our research capacity.
The projects are arranged by doctoral studies fields of IOSUD - UPT.*

EVOLUTION OF PROJECTS SUPPORTED BY PRIVATE FUNDS IMPLEMENTED BY UPT 2012-2015

A series of inter-institutional collaborations have crucially influenced UPT's ranking classification exercise between 2012 and 2015.

Two main categories of institutional collaborations are to be noted: inter-university collaborations and collaborations with enterprises. Each of them has clearly established, mutually-shared objectives: mutual support, know-how transfer, and cooperation objectives for a common output.

UPT has always maintained a close relationship with the community, with the external environment, this relationship being its own reason to exist. Beyond the actual research and formal education, the research accomplished through technological transfer has been a constant concern for the University departments, faculties and management structures, which is reflected in the number of contracts with private companies.

- This chapter presents a selection of the research contracts with third parties.

Evolution of projects supported by private funds

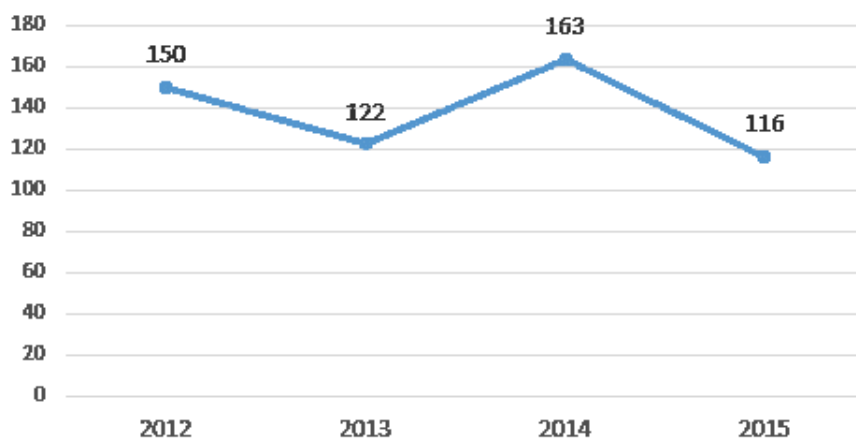

PHOTOVOLTAIC SOURCES INTEGRATION IN THE ROMANIAN POWER SYSTEM. CASE STUDY FOR TIMIS AREA

Goal of the project

Power system analysis and optimization for the photovoltaic sources integration in the Timis area of the Romanian Power System (Enel Banat Distribution Operator).

Short description of the project

The renewable energy sources represent an important issue for the Romanian and EU energy policy and sustainable development strategy. The projects refer to photovoltaic sources integration in the Timis area of the Romanian Power System (Enel Banat Distribution Operator). The analysis has been performed for the North-Western, Western, Central and South-Western part of the System. Various operating condition, with the consumption forecast for 2014, 2018 and 2023, were considered, taking into account all the renewable energy sources (wind, solar, biomass, hydro). The medium voltage network for the interest area was modelled in detail.

Project implemented by

- Enel Distribuție Banat
- GML Bio Energy
- Efficient Solar
- Pro Dance Show Timisoara

Implementation period

2014-2015

Main activities

- power system data base validation;
- Enel Banat distribution network modeling and operating condition analysis;
- power consumption and renewable energy generation forecast;
- power flow computing for various operating condition of the North-Western, Western, Central and South-Western part of the Romanian Power System (peak and minimum type regimes, 2013, 2018, 2023);
- contingency analysis, in the presence / absence of the renewable energy sources.



Results

- power flow corresponding to 2013 year and forecasted 2018 and 2023 years;
- power flow corresponding to the medium voltage electrical network (Enel Banat Timisoara area);
- voltage value without / with the new producers;
- quick / slow maximum voltage variation value for critical buses;
- transformer loading without / with the new producers;
- power flow through the power system elements and loading level;
- integration solution validation and system reinforcement recommendations (if necessary).

Applicability and transferability of the results

Knowledge transfer to other photovoltaic power plants developers and designers. Electrical distribution network operator (Enel, CEZ, EON, Electrica in Romania).

Fields of interest

- photovoltaic energy sources;
- other renewable energy sources;
- renewable sources' integration in the power systems;
- distribution network operators.

Research Centre

Research Centre for Power Systems Analysis and Optimization

Financed through/by

GML Bio Energy, Efficient Solar, Pro Dance Show Timisoara, total value: 18.786 RON (4.175 Euro)

Research team

Stefan Kilyeni, Constantin Barbulescu, Attila Simo, Annamaria Kilyeni

Contact information

Prof. Ștefan KILYENI, PhD
Department of Power Engineering
Address: Bd. Vasile Pârvan, No. 2, RO300223, Timisoara
Phone: (+40) 256 403 430
Mobile: (+40) 745 180 818
E-mail: stefan.kilyeni@upt.ro
Web: www.et.upt.ro

MICRO-HYDRO POWER PLANTS INTEGRATION IN THE ROMANIAN POWER SYSTEM. CASE STUDY FOR CARAS-SEVERIN AREA

Goal of the project

Power system analysis and optimization for the micro-hydro power plants integration in the Caras-Severin area of the Romanian Power System (Enel Banat Distribution Operator).

Short description of the project

The renewable energy sources represent an important issue for the Romanian and EU energy policy and sustainable development strategy. The projects refer to micro-hydro power plants integration in the Caras-Severin area of the Romanian Power System (Enel Banat Distribution Operator). The analysis has been performed for the North-Western, Western, Central and South-Western part of the System. Various operating condition, with the consumption forecast for 2014, 2018 and 2023, were considered, taking into account all the renewable energy sources (wind, solar, biomass, hydro). The medium voltage network for the interest area was modelled in detail.

Project implemented by

- Enel Distribuție Banat
- Termoforest Toplet

Implementation period

2014-2015

Main activities

- power system data base validation;
- Enel Banat distribution network modeling and operating condition analysis;
- power consumption and renewable energy generation forecast;
- power flow computing for various operating condition of the North-Western, Western, Central and South-Western part of the Romanian Power System (peak and minimum type operating conditions, 2014, 2018, 2023);
- contingency analysis, in the presence / absence of the renewable energy sources.



Results

- power flow corresponding to 2013 year and forecasted 2018 and 2023 years;
- power flow corresponding to the medium voltage electrical network (Enel Banat Timisoara area);
- voltage value without / with the new producers;
- quick / slow maximum voltage variation value for critical buses;
- transformer loading without / with the new producers;
- power flow through the power system elements and loading level;
- integration solution validation and system reinforcement recommendations (if necessary).

Applicability and transferability of the results

Knowledge transfer to other photovoltaic power plants developers and designers. Electrical distribution network operator (Enel, CEZ, EON, Electrica in Romania).

Fields of interest

- photovoltaic energy sources;
- other renewable energy sources;
- renewable sources' integration in the power systems;
- distribution network operators.

Research Centre

Research Centre for Power Systems Analysis and Optimization

Financed through/by

Termoforest Toplet, total value: 9.300 RON

Research team

Stefan Kilyeni, Constantin Barbulescu, Attila Simo, Annamaria Kilyeni

Contact information

Prof. Ștefan KILYENI, PhD
Department of Power Engineering
Address: Bd. Vasile Pârvan, No. 2, RO300223, Timisoara
Phone: (+40) 256 403 430
Mobile: (+40) 745 180 818
E-mail: stefan.kilyeni@upt.ro
Web: www.et.upt.ro

BIOMASS SOURCES INTEGRATION IN THE ROMANIAN POWER SYSTEM. CASE STUDY FOR TIMISOARA AREA

Goal of the project

Power system analysis and optimization for the biomass sources integration in the Timisoara area of the Romanian Power System (Enel Banat Distribution Operator).

Short description of the project

The renewable energy sources represent an important issue for the Romanian and EU energy policy and sustainable development strategy. The projects refer to biomass sources integration in the Timisoara area of the Romanian Power System (Enel Banat Distribution Operator). The analysis has been performed for the North-Western, Western, Central and South-Western part of the System. Various operating condition, with the consumption forecast for 2018 and 2023, were considered, taking into account all the renewable energy sources (wind, solar, biomass, hydro).

Project implemented by

- Enel Distribuție Banat
- Cons Electricarea Instal Timisoara

Implementation period

2014-2015

Main activities

- power system data base validation;
- Enel Banat distribution network modeling and operating condition analysis;
- power consumption and renewable energy generation forecast;
- power flow computing for various operating condition of the North-Western, Western, Central and South-Western part of the Romanian Power System (peak and minimum type regimes, 2013, 2018, 2023);
- contingency analysis, in the presence / absence of the renewable energy sources.



Results

- power flow corresponding to 2013 year and forecasted 2018 and 2023 years;
- power flow corresponding to the medium voltage electrical network (Enel Banat Timisoara area);
- voltage value without / with the new producers;
- quick / slow maximum voltage variation value for critical buses;
- transformer loading without / with the new producers;
- power flow through the power system elements and loading level;
- integration solution validation and system reinforcement recommendations (if necessary).

Applicability and transferability of the results

Knowledge transfer to other photovoltaic power plants developers and designers. Electrical distribution network operator (Enel, CEZ, EON, Electrica in Romania).

Fields of interest

- photovoltaic energy sources;
- other renewable energy sources;
- renewable sources' integration in the power systems;
- distribution network operators.

Research Centre

Research Centre for Power Systems Analysis and Optimization

Financed through/by

Cons Electricarea Instal, total value: 9.424 RON

Research team

Stefan Kilyeni, Constantin Barbulescu, Attila Simo, Annamaria Kilyeni

Contact information

Prof. Ștefan KILYENI, PhD
Department of Power Engineering
Address: Bd. Vasile Pârvan, No. 2, RO300223, Timisoara
Phone: (+40) 256 403 430
Mobile: (+40) 745 180 818
E-mail: stefan.kilyeni@upt.ro
Web: www.et.upt.ro

DOBROGEA ELECTRICAL DISTRIBUTION NETWORK ANALYSIS AND OPTIMIZATION

Goal of the project

Distribution network real technical losses evaluation for Enel Dobrogea Distribution System Operator. Power flow computing for various operating condition of the Southern and South-Eastern part of the Romanian Power System (peak and minimum type operating conditions) has been performed.

Short description of the project

The study was conducted for Enel Dobrogea Distribution System Operator. An algorithm is proposed by the authors being able to compute the load dependent and non-dependent technical losses. The analysis has been performed for the Southern and South-Eastern part of the Romanian Power System. Quantitative and qualitative on-field measurements are provided and discussed, followed by the technical losses computing based on the provided algorithm. Different necessary scenarios for the distribution network operator have been taken into consideration highlighting the optimal operating conditions. The wind farms operating in that area have been considered. Their influence (considering various operating conditions) over the real technical losses' value has been analyzed.

Project implemented by

- Enel Distribuție Dobrogea
- Servelect Cluj-Napoca

Implementation period

2014-2015

Main activities

- on-field power flow monitoring in case of several overhead lines;
- algorithm development for technical losses evaluation;
- electrical distribution network modelling;
- optimal power flow considering different scenarios;
- wind farm modelling;
- comparison and analysis based on the these approaches.

Results

- algorithm used for technical losses evaluation;
- electrical distribution network simulation model;
- technical losses' reduction methods.

Research Centre

Research Centre for Power Systems Analysis and Optimization



Applicability and transferability of the results

The algorithm used for technical losses evaluation is able to be applied in case of any distribution network operator. Also, based on the achieved experience, other (or similar) technical losses reduction methods could be highlighted in case of other distribution operators.

Fields of interest

- distribution network analysis;
- technical losses computing;
- loss reduction methods;
- distribution system operators.

Financed through/by

Servelect Cluj-Napoca, total value: 9.796 RON

Research team

Stefan Kilyeni
Constantin Barbulescu
Attila Simo
Annamaria Kilyeni

Contact information

Prof. Ștefan KILYENI, PhD
Department of Power Engineering
Address: Bd. Vasile Pârvan, No. 2, R0300223, Timisoara
Phone: (+40) 256 403 430
Mobile: (+40) 745 180 818
E-mail: stefan.kilyeni@upt.ro
Web: www.et.upt.ro

STUDIES AND RESEARCH REGARDING TOPOGRAPHIC ENGINEERING SURVEYS FOR 3D REPRESENTATION AND MODELING OF THE ENTRANCE OF PRESSURE VESSELS

Goal of the project

3D representation and modeling of the entrance of pressure vessels

Short description of the project

The project involved topographic measurements using methods and technologies specific to surveying engineering in order to obtain tridimensional representations of the entrance of pressure vessels.

- Realizing planimetric and altimetric measurements of the pressure vessels;
- The topographic surveys is executed in a local reference system. The positions (given in coordinates) of the benchmarks (reflector tapes) installed by the beneficiary on the exits of the pressure vessels have been determined.
- Creating 3D models of the pressure vessels

Traditional survey methods generally require access to any points that need to be measured. One exception would be to record a vertical and horizontal angle to a single point from at least two different positions. The coordinates could then be calculated. While this is possible, it would also be time consuming, especially if there were a large number of "hard-to-see points".

Regarding precision, the words accurate and precise are generally interchangeable. In surveying however, accuracy and precision refer to separate results. Accuracy refers to the result's closeness to the true or accepted value. Precision refers to the spread of results for a number of measurements.

Project implemented by

Assoc. prof. Sorin Herban

Implementation period

BC 68 / 16.06.2015 - 45 days

Main activities

- Topographic surveys using high performance total stations and processing of data using specialized software

Results

- Realizing 3D models of the pressure vessels



Applicability and transferability of the results

Pressure vessel engineering technology is of importance in many branches of industry. Its practical application could lead to major improvements in economy, reliability and environmental effects

Financed through/by

SC Pressafe SRL

Research Centre

Research Centre for Construction and Transportation Substructures

Research team

Assoc. Prof. Sorin Herban, PhD
Prof. Carmen Grecea, PhD
PhD student Adrian Alionescu
Lecturer Cosmin Mușat, PhD
Lecturer Alina Bălă, PhD
Asist. Prof. Beatrice Vilceanu, PhD

Contact information

Assoc. prof. Sorin HERBAN, PhD
Civil Engineering Faculty
Address: Traian Lalescu Street, No. 2, RO 300223, Timișoara
Phone: (+40) 256 403978
Mobile: (+40) 722223952
E-mail: sorin.herban@upt.ro
Web: <http://www.ct.upt.ro/users/SorinHerban/index.htm>

TECHNICAL REPORT – MODERNIZATION OF STREETS, SETTING UP CYCLE TRACKS IN THE TOWN OF JIMBOLIA

Goal of the project

Examination of the works realized on the streets and cycle tracks in the town of Jimbolia, from the point of view of the conformity of the technical characteristics and the materials with the specifications of the technical documentation based on which the works had been performed

Short description of the project

The non-conformities presented in detail in the reception report drawn up at the completion of the works were verified based on the design characteristics stipulated by the project.

Project implemented by

The City Hall of the town of Jimbolia

Implementation period

2015-2016

Main activities

- site inspection of the works;
- sampling of 400 x 400mm square cores;
- sampling of Ø 100mm cylindrical cores;
- realization of open soundings in the road pavement, down to the formation level, on the location where square cores were taken;
- determination of the road pavement composition (types of layers, thicknesses of layers);
- determination of the bituminous pavement thickness;
- verification of the quality of the asphalt mixture in the bituminous layers through laboratory tests on the samples taken (bitumen content, particle size distribution in the natural aggregate, apparent density, rate of compaction, water absorption, Marshall stability, flow index, stability-flow ratio).

Financed through/by

City Hall of the town of Jimbolia



Results

- the bitumen content of the cores sampled from the realized pavement is inferior to the one stipulated by the standard SR 174 - 1 - 2009 (5,5...7,0%) on several streets (7 samples out of the 9 analyzed).
- the bitumen content on the samples taken from the realized pavement is generally inferior to the one stipulated by the standard SR 174 - 1 - 2009 (5,5...7,0% for B.A. 25, and respectively 6,5...7,5% for B.A. 8);
- the rate of compaction does not range between the limits stipulated by the technical prescriptions (min. 96 %, according to SR 174 - 1 - 2009);
- the real water absorption (on samples taken from the bituminous layers) does not range between the limits stipulated by the technical norms (2...5% vol., according to SR 174 - 1 - 2009);

Applicability and transferability of the results

Alternative technical solutions are taken into consideration in order to valorize the realized works, taking adequate maintenance and operations measures. The realized works can be accepted provided that their operation behavior is carefully watched during the entire design life. To this purpose, a concrete follow up program is to be drawn up. The administrator of the realized transport infrastructures will take the due measures to implement the follow up program of the time behavior, and to perform the required maintenance works respectively.

Research Centre

Research Centre of Infrastructures for Constructions and Transportation – ICT-

Research team

Prof. Gheorghe Lucaci, PhD, Prof. Florin Belc, PhD, Asist. Paul Teodor Marc, PhD, Ing. Andrei Forton

Contact information

Prof. Gheorghe LUCACI, PhD
Civil Engineering Faculty
Address: Str. Ioan Curea, No. 1A, 300224, Timisoara
Phone: (+40) 256 403961
Mobile: 0722625184
E-mail: gheorghe.lucaci@upt.ro
Web: <http://www.ct.upt.ro/cctfc/index.htm>

TECHNICAL EXPERTISE DN 18 BAIJA MARE – SIGHETU MARMATIEI, PART B KM 15 + 000 – 38 + 104 AND PART E KM 52 + 202 – 62 + 234

Goal of the project

The project aims at drawing up a technical expert report and providing technical consultancy services in relation to the road pavement and the culverts on the mentioned sections of the national road DN 18 with a view to proposing a new road pavement solution

Short description of the project

The contract involves the elaboration and delivery of the Technical Expert Report, including investigations on site, technical consultancy, typical profiles and all necessary supporting documents; it implies sustaining the technical expert report in front of the Beneficiary's Technical Economical Committee.

Project implemented by

The project will be implemented by C.N.A.D.N.R. Bucuresti – D.R.D.P. Cluj for changing the solution proposed in the initial project.

Implementation period

2014-2015

Main activities

Multidisciplinary activity domain, comprising chapters of investigation concerning the degradation condition, of comparative calculations concerning the dimensioning of the proposed road pavement versus the newly proposed solution and engineering structures.

Results

By applying the results offered by the Technical Examination Report the newly proposed technical solution was accepted and will be implemented.

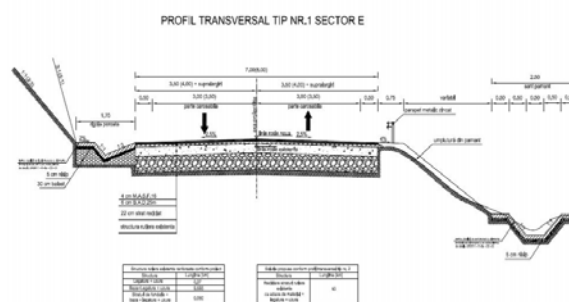
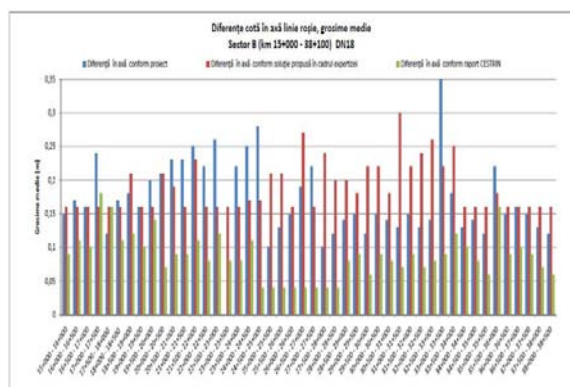

Applicability and transferability of the results

Based on the solutions offered by the Technical Expert Report, the newly proposed design solution is much more efficient due to the reduced time and cost of execution.

Financed through/by

C.N.A.D.N.R. Bucuresti - D.R.D.P. Cluj

Research Centre

Research Centre of Infrastructures for Constructions and Transportation -ICT-

Research team

Prof. Gheorghe Lucaci, PhD
Prof. Florin Belc, PhD
Assoc. Prof. Adrian Bota, PhD
Assist. Prof. Paul Marc, PhD
Alin Buzuriu, PhD Student

Contact information

Prof. Gheorghe LUCACI, PhD/ Prof. Florin BELC, PhD
Department of Overland Communication Ways, Foundations and Cadastral Survey
Adress: Ioan Curea Street, No. 1, RO300224 Timisoara
Phone: (+40) 256 403 963/ (+40)256 403 965
E-mail: gheorghe.lucaci@upt.ro/ florin.belc@upt.ro
<http://www.ct.upt.ro/cctfc/index.htm>

TECHNICAL-ECONOMICAL DOCUMENTATION REGARDING THE REHABILITATION MEASURES OF THE EMBANKMENT “PRAG 09 – INTERNATIONAL AIRPORT SIBIU”

Goal of the project

The purpose of the technical-economical evaluation was to design the necessary construction works for the embankment rehabilitation of “Prag 09 – International Airport Sibiu”, including estimation and detailing of the necessary costs for execution of the construction works and the technological stages of execution.

Short description of the project

The extension of the Airport runway, within the modernization and expansion works of the International Airport Sibiu, required achieving an embankment up to 28 m height in the western direction. On August 2010, at the western end of the Airport runway, a collapse of the embankment has occurred, manifested through the fall of the soil mass on a depth of approximately 10 m in the runway axis and approximately 3–4 m on the edges of the embankment. The dimension of the collapsed area is approximately 250 m in length and 100 m wide.

The collapse of the tall embankment from the western part of the International Sibiu Airport was a very complex phenomenon, where numerous factors concurred, including the foundation ground, embankment profile, fill material used at the execution of the embankment, faults in the collection and drainage of the surface water, implemented drainage system.

Project implemented by

Given the fact, that this technical-economical evaluation is part from a judicial expertise, the project will be implemented at the end of the trial settlement agreement in which the International Airport Sibiu, designer, consultant and constructor are part of.

Implementation period

2014–2015



Main activities

Multidisciplinary activity domain, comprising chapters of soil mechanics, foundation engineering, geodesy, roads and engineering structures.

Results

By applying the solutions given by the technical-economical evaluation, the resistance and the stability of the embankment will be fulfilled, thus ensuring the integrity of the runway and normal landing and departure conditions of airplanes at the International Airport Sibiu.

Financed through/by

International Airport Sibiu

Research Centre

Research Centre of Infrastructures for Constructions and Transportation -ICT-

Research team

Professor Marin Marin, PhD.
Senior Lecturer Octavian Roman, PhD.
Senior Lecturer Monica Mirea, PhD
Senior Lecturer Alexandra Ciopec, PhD
Assistant Professor Luiza Roman, PhD.

Contact information

Assistant Professor Paul MARC, PhD
Department of Overland Communication Ways, Foundations and Cadastral Survey
Address: Ioan Curea Street, No. 1, RO300224 Timisoara
Phone: (+40)256 403 972
E-mail: paul.marc@upt.ro
Web: <http://www.ct.upt.ro/cctfc/index.htm>

AIR QUALITY MEASUREMENTS - IN 8 LOCATIONS OF TIMIȘOARA

Goal of the project

- Depicting air quality characteristics during the summer episodes
- Continuous monitoring in potential risk areas, selected by the Municipality
- Applicability of only accredited measurement techniques and fully of standard ISO 17025
- Meteorological data acquisition and monitoring
- Graphic and Table presentation of the monitoring results presenting the NO, NO₂, NO_x, SO₂, CO, PM₁₀, O₃, CH₄, COV, COT concentrations
- Interpretation the results, mainly by the legal limits, but also by comparison of the results measured in the North and South area of the city.
- Proposal of potential possibilities to reduce the risks for the future, based on the achieved results

Short description of the project

- The air quality of urban air is of maximum importance for the sustainable development of the society. Thus in Timisoara in addition to the fix monitoring devices, owned by the Ministry of Environment, Water and Forest, in particular locations, using a mobile laboratory, representative measurements have been carried out, for depicting especially, during the interval June-October 2015, the species that are registering exceeding over the legal limit, and focusing especially on particulate matter PM.
- The episodes covered more than 6-7 days, and refer to traffic induced polluted areas, industrial areas, as well as areas that should be protected (as they are close to schools, kindergartens, blocs of flat, residential neighborhoods, etc.)

Table 1 -Locations that were subject of the continuous on line measurements

Calea Aradului nr. 56 (cartier Aradului)	04 - 11.06.2015
str. Silviu Motohon nr. 53 (cartier I.I. de la Brad)	13 - 14.06.2015 17 - 23.06.2015
str. I.I. de la Brad nr. 2 (cartier I.I. de la Brad)	26.06-03.07.2015
str. Moise Nicoară nr. 17, (cartier Fabric)	07.07-17.07.2015
Calea Martirilor nr. 64 (cartier Calea Girocului)	01.09-08.09.2015
str. Chișodei nr. 1 (cartier Fratelia)	08 - 15.09.2015
str. Mureș nr. 8 (cartier Calea Șagului)	17.09-25.09.2015
Piața Doina (cartier Calea Șagului)	29.09-06.10.2015

Implementation period

June- November 2015

Project implemented by

Politehnica University of Timisoara through Laboratory for fuel, ecological analysis, and dispersion of pollutants (Laboratorul de Analize de Combustibili, Investiții Ecologice și Dispersia Noxelor - LaCIEDiN)



Main activities

- Positioning of the lab with access to electrical supply and not affecting the normal activities
- Calibration of all instruments, running basic tests
- Starting of the continuous measurements and creating the data base
- Control of the results
- Control of the equipments by daily check (recalibration with control gases, DAKK type)
- Generating the results based on the filtered real data
- Interpretation of the results
- Indication of potential solution for corrections of the state of art

Results

- In reference to PM₁₀, one attested several episodes (locations, time intervals) when the limits were exceeded. PM₁₀ (and as well PM_{2.5}) are very dangerous and solutions (continuous and preventing) have been proposed. They are general such as correct control at the source (mobile, industrial fix, residential fix, surface sources), but also to fluidization of the traffic (especially using the space for rolling and not parking), concept of internal rings, finalization of the major external ring road, plantation of more green areas , etc.

Results

- A comparison between episodes monitored in the South and the North of the city does not highlight special aspects concerning to what it is already known: overcoming the occasional average PM10 are also seen with preponderancy in the area is South. But it is certain that all measured concentrations (gaseous) are directly proportional to traffic (intensity, quality fleet way of traveling, fluency control systems, etc.). Limiting the source of emissions (industrial, domestic, of any kind, even small) must continue and just a quality management in companies (public and private) can minimize background pollution (level overlapped emission from polluting vehicles or other sources) in a city. The shift to a quality public transport (comfort associated) covering sensitive areas, but best of all (including peri-urban areas) is of course a method as known, recommended by many studies that can prove and enforce clear beneficial effects.

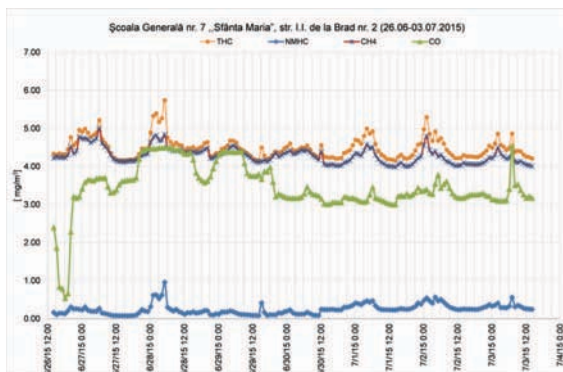

Average (over 60 minutes) concentrations: THC, NMHC, CH₄, CO

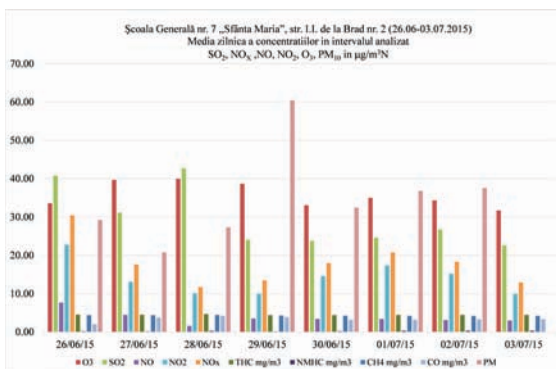

Average (over 24 hours) concentrations

Applicability and transferability of the results

- Increasing the surface of green spaces in order to achieve the goal of more than 26 m² / capita, including as well play, entertainment, sports, creative areas, traffic regulations, creating of new spaces, free traffic (pedestrian and bicycle) - especially in the historical and cultural areas - will certainly contribute to reducing pollution. Also, continuous monitoring by stations permanently, but also through mobile laboratories accredited located in areas endangered (or likely to be jeopardized by seasonal various human activities) are other needs and direct tasks of the Municipality for the future, which must take major responsibilities in preserving air quality, the minimum condition for a civilized life and sustainable development of the city, providing public health in the short, medium and long term and reducing risks.
- The research demonstrates that an independent accredited body, conducting professional & responsible activities, in accordance with legal requirements and regulations may examine successful and monitor air quality, making a decisive contribution to ensuring the comparability of results of assessment and compliance, generating confidence in the quality and safety of services.
- Measurements were performed according demands for bodies accredited laboratories, inspection bodies and certification as stipulated in the standard DIN EN ISO 17011th / IEC. This standard defines accreditation as "confirmation by a third party, which officially establishes that a conformity assessment body is competent to carry out specific conformity assessment tasks".

Financed through/by

Timisoara Municipality

Research team

Ioana Ionel,
Daniel Bisorca
Ramon Mihai Balogh
Adrian Ţenchea
Delia Gabriela Călinoiu

Contact information

Prof. Ioana IONEL, PhD
Department for Mechanical Machines, Equipment and Transportation
Address: Bd. Mihai Viteazul, No.1, RO300222, Timisoara
Phone: (+40) 256 403670
Mobile: 0723 349337
E-mail: ioana.ionel@upt.ro
Web: www.mediu.ro

LABORATORY TRIALS AND TESTS FOR THE IDENTIFICATION OF THE OPTIMUM MIXTURE (PREPARATION) OF THE DENSE SLURRY OF ASH, FLY ASH, SULPHUR REMOVAL BY-PRODUCT FROM CET SUD, FOR HYDRAULIC TRANSPORTATION OF THE NEW RESULTING SLURRY, WITH THE EXISTING EQUIPMENTS, AT UTVIN DEPOSIT OF ASH AND FLY ASH

Goal of the project

- The aim of the research activities consists in the reduction of the natural environment pollution due to the waste resulting from CET Timisoara. The resulted materials from the burning process, the fly ashes, are transported through pipes to an open deposit placed nearby Utvin village. To reduce the atmosphere and underground water pollution due to wind and water infiltrations into the soil, the fly ash is transported and deposited as dense slurry. By the research activity are determined the geotechnical parameters of the deposited slurry as a granular cemented material, stable from mechanical point of view after the sedimentation process.

Short description of the project

- A. Experiments and laboratory findings to identify optimal blending network (preparation) of the sludge ash, slag, a by-product of desulphurization at CET South Timisoara, ensuring the resulting slurry transport depot slag safely without deposits on pipes or installations.
- B. Studies and laboratory determinations for establishing the category of waste and inert waste confirmation of the rock resulting from the sludge from waste combustion from CET Sud Timisoara to the new profile.
- Providing the services is the performance of the University Politehnica Timisoara at the request of local companies District COLTERM SA, analysis and determinations laboratory for getting the recipe optimal preparation of the sludge corresponding to the new profile and to adapt the existing operation of technology exhaust slag and slurries dense ash from CET Sud Timisoara to new operating conditions, which require:
 - The need for transport of desulfurization by-products (deriving from the treatment of flue gas);
 - The need for evacuation as dense and desulfurization sludge resulting from the treatment of flue gases;
 - requirement, compliance provisions: operating permits safe deposit ash and slag Utvin issued by the Ministry of Environment and Forests, nr. 202/3 / 20.12.2010 and the advice C.O.N.S.I.B. no. 202/3/2010;
 - The obligation of compliance with legal regulations, such as for example:
 - O.U.G. 244/2000 (Dam Safety Ordinance).
 - Quality Construction Law - Law No.10 / 1995, Section 5 (Obligations and responsibilities of building owners), article 25, pct.c), as amended and supplemented.

Implementation period

May-October 2015



Instruments used for the research in UPT labs

Main activities

- Step 1 – Determination of the recipe and permeability characteristics of the dense sludge
- Step 2 - Chemistry laboratory tests on components of the sludge, the sludge dense rock and water seepage
- Step 3 - Laboratory measurements on materials such as consolidated lands

Results

- In order to prepare the new recipe comprising dense slurry and desulfurization residue or residues it is necessary to delay the crystallization of the products of chemical reactions based on calcium residue contained in the desulfurization.
- The time delay for the solidification of the sludge and residue comprising the desulphurisation product is realized in two ways: by using liquid additives or carbonation of the desulfurization residue using flue gas CO₂.
- By applying the method for the preparation of the sludge using liquid additives to give a reaction retarding the solidification / crystallisation the resulted properties do not affect the curing of the slurry stored in the discharge of the sludge and the thus prepared material retains its pumpability for a period of 120 min.

Results

- If an extension of the delay time of solidification of the sludge is desired one must apply recipes with additives with increased use of additives.
- One recommends the additive AD2 - WRDA 31 / R or similar, based on its technical report / comparable price.
- Technologically method of preparation of the sludge using liquid additive is much easier to implement and involves minimal changes in the sludge preparation facility exists inside CET South Timisoara.
- Experiments on the pilot plant for the preparation of the sludge by the method of carbonating are not conclusive but promising.
- Preparation of the sludge residue desulphurization by carbonation is possible to be implemented by the CET South Timisoara, but this is technologically difficult, as in order to implement it requires complex installations for carbonation which are major energy consumption.
- To prevent fouling of the pipe in the warehouse slurry transport system it is recommended to maintain optimal speed transmission through the pipelines pin the sludge; and states the use of additives which retard crystallization phenomena during the transport of the sludge in the hydraulic storage.
- The results of the performed laboratory tests pointed out that the granular material deposited as dense slurry (composed of 70 % fly ash and 30 % sulfur removal by-product) transforms after the pumping and depositing process in a material with high resistances, stable from mechanical and chemical point of view.

Applicability and transferability of the results

1. Treatment process of residues resulting from the incineration of household waste by means of solidification – stabilization of the roc ash
2. Integration process for the sub-product of the dry desulphurization by a recipe of dense slurry for the hydraulic transport through pipeline system.

Financed through/by

District Local Company) COLTERM S.A



Test rig built up for the research (original set up) mounted in the UPT lab and on spot at the beneficiary for final tests

Research Centre

- Research Centre for Thermal Machines and Equipments, Transportation and Environmental Pollution Control
- Research institute for renewable energy – ICERTM

Research team

Ioana Ionel	Mihaela Ciopec
Mihai Reinhold Wächter	Florin Manzatu
Petru Negrea	Ion Bogdan
Cătălin Badea	Ioan Petru Boldurean
Alexandra Ciopec	Sorin Dan
Dumitru Cebrucean	Liana Iureş
Adina Negrea	Remus Chendeş
Giannin Mosoarca	Ovidiu Susa

Contact information

Prof. Ioana IONEL, PhD
 Department for Mechanical Machines, Equipment and Transportation
 Address: Bd. Mihai Viteazul, No.1, RO300222, Timisoara
 Phone: (+40) 256 403670
 Mobile: 0723 349337
 E-mail: ioana.ionel@upt.ro

THE THERMAL MANAGEMENT OF THE SPACECRAFT SYSTEMS USING THE HIGH DENSITY HEATERS

Goal of the project

The main issue is to find the optimal solution of the high density heater assembly used for thermal management of the satellite system, both from geometrical and heater type point of view.

Short description of the project

The topic of the project is thermal management of the spacecraft systems with emphasize on heat dispersion of the specific heat transfer rate inside the closed loop of the thermal system. Although the majority of the existing systems involves heat pipes as a circulating devices, in this case classical heat exchange loop with refrigerant is applied with heat pipes used only for rejection of the heat to the outer space. So related strictly to the thermal management of the high density heaters, the main issue is related to conjugate heat transfer phenomena.

Project implemented by

Politehnica University of Timisoara/ Faculty of Mechanical Engineering

Implementation period

27.05.2015 – 31.01.2016

Main activities

- Establish the mathematical model for conjugate heat transfer and fluid flow phenomena.
- The conjugate heat transfer and fluid flow numerical simulations.
- The analyzing of the numerical results.
- The optimization of the proposed solution.

Results

The following results are emphasized throughout the project:

- Based on the numerical simulations, the temperature field for high density heater assembly for various heater types and dispersed power is obtained.
- The hot spots for different elements of the high density heater assembly are identified.

Applicability and transferability of the results

- The results are primarily dedicated to specific part of the thermal satellite system but they might be used in any other system that involves the same phenomena of conjugate heat transfer.

Financed through/by

Zoppas Industries Romania S.R.L.

Research Centre

Research Center for Thermal Machines and Equipment, Transportation and Pollution Control

Research team

Professor Dorin Lelea, PhD
Ioan Laza, PhD Researcher
Evelin Laza, PhD Researcher

Contact information

Prof. Dorin LELEA, PhD
Faculty of Mechanical Engineering
Department for Mechanical Machines, Equipment and Transportation
Address: Str. Bv. Mihai Viteazu, No. 1, Postal Code 300222, Timisoara
Phone: (+40) 256 403661
Mobile: (+40) 746 088172
E-mail: dorin.lelea@upt.ro
Web: www.researchgate.net/profile/Dorin_Lelea

DIAGNOSTIC ANALYSIS OF TRAINING NEEDS IN THE FIELD OF LEAN SIX SIGMA

Goal of the project

The project aims to offer CONTINENTAL AUTOMOTIVE ROMÂNIA S.R.L. a methodology based on measurement instruments, analysis tools, and productive thinking methods, which, adequately implemented will trigger a cultural change and an increased focus on continuous improvement in all corporate activities.

Short description of the project

For a successful implementation of the Lean Six Sigma methodology at CONTINENTAL AUTOMOTIVE ROMÂNIA S.R.L. the project has developed:

- A clear communication plan.
- Incentives for individuals to overcome change resistance.
- Education and training for the senior managers along with employees on the tools, techniques and benefits of Six Sigma.
- Consultancy for managers and employees in applying and implementing complex Six Sigma projects effectively in the firm.

Project implemented by

Management Department

Implementation period

April-December 2015

Main activities

1. Development of a qualitative approach – focus groups with quality managers from CONTINENTAL AUTOMOTIVE ROMÂNIA S.R.L. regarding the project's communication plan.
2. Construction of an introductory Lean Six Sigma course.
3. Implementation of a qualitative questionnaire before and after the course.
4. Realization of ten training sessions with approximately 15 employees to introduce the Lean Six Sigma mentality and help start over 100 improvement projects in production, logistics and maintenance departments.
5. Supervision and consultancy for all individual Six Sigma projects.

Results

- 1 paper (ISI) published in a journal with an impact factor of 1,323 (in press)
- 3 papers published in conference proceedings (to be indexed ISI and BDI)

Applicability and transferability of the results

- Dissemination of results at international conferences.
- Improved university-industry relationships.
- Over 60 discussed and implemented individual improvement projects in CONTINENTAL AUTOMOTIVE ROMÂNIA S.R.L. based on the Lean Six Sigma methodology.

Financed through/by

CONTINENTAL AUTOMOTIVE ROMÂNIA S.R.L.

Research Centre

Engineering and Management Research Centre

Research team

Assoc. Prof. Adrian Pavel Pugna, Ph.D.

Prof. Marian Mocan, Ph.D.

Assist. Prof. Sabina Potra, Ph.D.

Assoc. Prof. Romeo Negrea, Ph.D.

Assist. Prof. Larisa Ivaşcu Ph.D.

Attila Turi, Eng. – Ph.D. student

Contact information

Assoc. Prof. Adrian Pavel PUGNA, Ph.D. Eng.

Management Department

Address: Remus Street, No.14, Postal Code 300191, Timisoara

Phone: (+40) 256 404 041

E-mail: adrian.pugna@upt.ro

CONT BENEFIT ANALYSES – INTERMODAL TERMINAL, SECOND STAGE – EXTENSION RAILPORT ARAD

Goal of the project

Starting from the requests from the Transport Master plan and from the fact that the intermodal terminal is addresses only to the freight transport in containers, the analysis explore the actual objectives proposed for this project. The objectives are the following:

Developing operation infrastructure of the Curtici Intermodal terminal from 68.000 TEU per year to 118.690 TEU per year;

Increasing the use degree of the transport corridor 7 by increasing the number of freight trains that transit it;

Developing a new RO-LA facility operational to Railport Arad;

Reducing environment pollution by only using transport with containers with low implications regarding the environment.

Short description of the project

The proposed investment is represented by the development of the Intermodal terminal, stage II – extending CURTICI RAILPORT. The exact location of the investment will be in Curtici, Arad County at the border between Hungary and Romania. This location will be crossing by two European Core Network Corridors and the total investment is 8.443.800 Euro.

Project implemented by

Railport Arad SRL

Implementation period

January 2015-June 2015

Main activities

- Identification of the investment
- The main purpose of the financial analysis undertaken was to determine the project cash flow forecasts in order to calculate suitable net return indicators. A particular emphasis was placed on two financial indicators: the Financial Net Present Value (FNPV) and the Financial Internal Rate of Return (FRR), respectively in terms of return on the investment cost, FNPV(C) and FRR(C), and return on national capital, FNPV(K) and FRR(K).
- For the determination of the financial return the Discounted Cash Flow (DCF) approach was considered. A discount rate of 5% has been applied within the financial analysis, which represents EC standard financial real discount rate.
- Financial analysis was performed on incremental cash flows, resulting from the comparison of two situations: the situation “without project” or BAU alternative and situation “with project”.
- In the situation “without project” the company’s activities continue as usual, without new investments, which mean that in 2015 it will reach its maximum operating capacity.
- Situation “with project” reflects the expansion, modernization and provision of intermodal terminal with new operating capacity, as described in paragraph investment costs.

Results

The present analyses used the methodology presented in Guide to Cost Benefit Analysis of Investment Projects edition July 2008 printed under supervision of European Commission – Directorate General Regional Policy.

After carrying out comprehensive analysis revealed the following:

- The best alternative in economic terms is that the investment of 8,443,800 Euro
- This investment can not only supports private funds for economic indicators do not allow this, the participation of European Union funds being obligatory in order to achieve
- The investment is appropriate and necessary
- Investment is expected to be completed in the second half of 2017
- Overall risk of investment is low
- The economic impact will be substantial, the environment will be minimal.

Applicability and transferability of the results

The results was use to analyze the opportunities for a private investment and to have the negotiation with banks.

Financed through/by

Railport Arad SRL

Research Centre

Research Centre Engineering and Management

Research team

Marian Mocan, Camelia Lupulescu, Attila Turi

Contact information

Prof. Marian MOCAN, PhD
Department of Management
Assress: Remus Str.14, 300191Timisoara
Phone: (+40) 256 404284
Mobile (+40) 722356292
E-mail: marian.mocan@upt.ro

MONITORING THE QUALITY OF WASTES FROM TECHNOLOGICAL PROCESS

Goal of the project

The project objective is to monitoring the quality of wastes from technological process.

Short description of the project

During the project various parameters of wastes are analyzed periodical from samples collected by the beneficiaries. The analyzed parameters and the times for the samples collections are commonly agreed by the beneficiaries and by the execution team. The analysis of the main parameters for the monitoring the quality of wastes are required for their storage according to law.

Project implemented by

- Faculty of Industrial Chemistry and Environmental Engineering.
- Department of Applied Chemistry and Engineering of Inorganic Compounds and Environmental.

Implementation period

01.10.2014-01.10.2015

Main activities

- During the project will be analyzed the volatile organic compounds and (COV) analyzed the waste from Waste Water Treatment.
- Its determinates the concentration of the following parameters: Cr, Cu, Ni, Cd, Pb, Nt, Pt, pH, humidity and loss on ignition from water.
- The main parameter are analyzed dailies and other are analyzed monthly in accordance with the achieving plan established by the both parts involved in the project.

Results

1. The volatile organic compounds (VOC) were analyzed from waste water.
2. It was determined the concentration of heavy metals in sludge from the process
3. It made sludge leaching tests

Applicability and transferability of the results

The results are consistent with the legislative framework in force.

Research Centre

Research Centre for Environmental Science and Engineering

Financed through/by

Research-Development and Consultancy Contract with S.C. FLEXTRONICS ROMANIA S.R.L.

Research team

Mihaela Ciopec, PhD

Contact information

Mihaela CIOPEC, PhD
Department of Applied Chemistry and Engineering of Inorganic Compounds and Environmental.
Address: Bd. Vasile Parvan, No. 6, RO300223, Timisoara
Phone: (+40) 256 404 192
Mobile:)+40) 722 806 880
E-mail: mihaela.ciopec@upt.ro

ENVIRONMENTAL MONITORING BY PHYSICO-CHEMICAL METHODS

Goal of the project

The project objective is to monitoring the quality water used in dialysis.

Short description of the project

During the project various parameters of dialysis water are analyzed periodical from samples collected by the beneficiaries. The analyzed parameters and the times for the samples collections are commonly agreed by the beneficiaries and by the execution team. The analysis of the main parameters for the monitoring of dialysis water quality are needed to see if they fit into the maximum admissible concentration of legislation.

Project implemented by

- Faculty of Industrial Chemistry and Environmental Engineering.
- Department of Applied Chemistry and Engineering of Inorganic Compounds and Environmental.

Implementation period

05.01.2015-05.01.2016

Main activities

- During the project will be analyzed the metal ions from the dialysis water
- The water samples are analyzed monthly

Results

1. Monthly are analyzed three samples of water (water network, deionized water and permeate) to determine the concentrations of metal ions.

Applicability and transferability of the results

The results are consistent with the legislative framework in force.

Research Centre

Research Centre for Environmental Science and Engineering

Financed through/by

Research-Development and Consultancy Contract with S.C. NEFROMED S.R.L.

Research team

Mihaela Ciopec, PhD

Contact information

Mihaela CIOPEC, PhD
Department of Applied Chemistry and Engineering of Inorganic Compounds and Environmental.
Address: Bd. Vasile Parvan, No. 6, RO300223, Timisoara
Phone: (+40) 256 404 192
Mobile:)+40) 722 806 880
E-mail: mihaela.ciopec@upt.ro

TESTING TECHNIQUES OF EQUIPMENT FOR REMOVAL OF TOXIC COMPOUNDS FROM THE AIR COMING FROM INDUSTRIAL AND DOMESTIC APPLICATIONS

Goal of the project

The project objective is to eliminate toxic pollutants from the air from industrial and residential applications using a purifying lamp.

Short description of the project

In order to eliminate toxic pollutants in the air from industrial and residential applications in project were carried out a series of tests using a purifying lamp (ORIN) that has the capacity to remove the toxic compounds (VOC, H₂S, NH₃).

The gases were monitored in a certain range time using a gas analyzer type MultiRAE SYSTEMS.

Project implemented by

- Faculty of Industrial Chemistry and Environmental Engineering.
- Department of Applied Chemistry and Engineering of Inorganic Compounds and Environmental.

Implementation period

01.10.2015-01.10.2016

Main activities

- Tests on the elimination of toxic compounds from the air using an electric device which produces negative ion purifier.

Results

1. To eliminate toxic compounds (VOC, H₂S, NH₃) in the air, it used a test cabin with size of 0.5 m³ which was introduced pollutant this is ventilation some time for homogenization (15mins).
2. From experimental data obtained notes that all toxic compounds studied has been a significant decrease to pollutant content in the air in time.

Applicability and transferability of the results

The results are consistent with the legislative framework in force.

Research Centre

Research Centre for Environmental Science and Engineering

Financed through/by

Research-Development and Consultancy Contract with S.C. DITTO S.R.L

Research team

Mihaela Ciopec, PhD

Contact information

Mihaela CIOPEC, PhD
Department of Applied Chemistry and Engineering of Inorganic Compounds and Environmental.
Address: Bd. Vasile Parvan, No. 6, RO300223, Timisoara
Phone: (+40) 256 404 192
Mobile:)+40) 722 806 880
E-mail: mihaela.ciopec@upt.ro

NEW CLASSROOM MATERIALS FOR COMPUTER AIDED MATHEMATICS

Goal of the project

Mathematics is, educationally and as a discipline, strongly influenced by computers in a wide spectrum of modes and at all levels of comprehension. The project objective is to improve teaching practice, to find the ideal mix between classical methods and the computer based ones, to develop GeoGebra applications which are useful to understand abstract mathematical notions and to produce dynamic and interactive documents dedicated to the first-year mathematics courses.

Short description of the project

There are two main advantages of GeoGebra in classroom: - the dual graphic view capability, which allow to simultaneously visualize two graphical representations and facilitates the study of transformations of the complex plane and of complex variable functions; - the dynamic build in tools which allow to animate, to hide or reveal graphics and text.

Project implemented by

1. Department of Mathematics
2. GeoGebra Institute of UPT

Implementation period

26.06.2012-01.06.2016

Main activities

- Weekly meetings with students at Geogebra Institute of UPT
- Support materials for life-long education of math teachers.
- Direct sharing of documents and teaching experiences over CEEPU Network
- Periodic uploads to GeoGebra Tube.

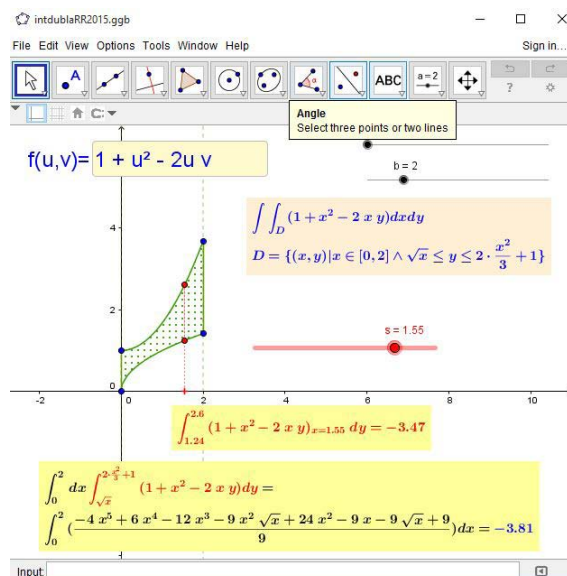

Results

- Applets for Calculus: Implicit functions, Random integral sum, Double integrals, Fourier series and Gibbs phenomenon, The Cubic root of complex numbers, Simple convergence versus uniform convergence.
- Applets for Linear Algebra and Geometry: Linear transformations in the real plane and 2x2 matrices; Dynamically generated 2D curves, About oriented curves.
- Applets for Applied Mathematics: Differential equations and stability, About Shannon sampling theorem.

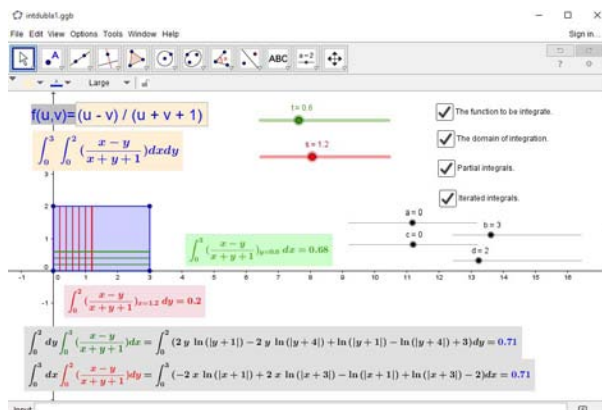

Applicability and transferability of the results

- All GeoGebra applets can be classified as didactical modeling and are appropriate to be utilized in the classroom.
- GeoGebra Institute of UPT is partner of CIII-HU-0028-08-1415 CEEPUS Network "Active Methods in Teaching and Learning Mathematics and Informatics" (Network coordinator PhD Péter Körtesi, University of Miskolc, Hungary).

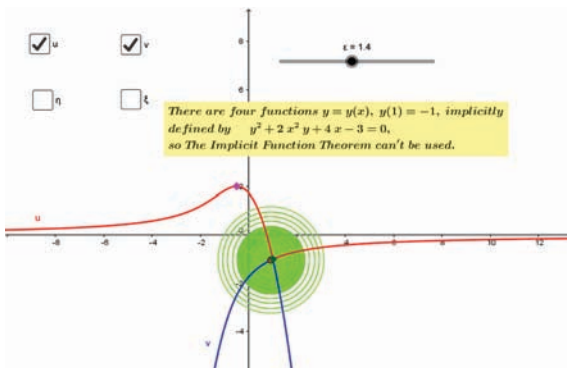

Research Centre

GeoGebra Institute of UPT

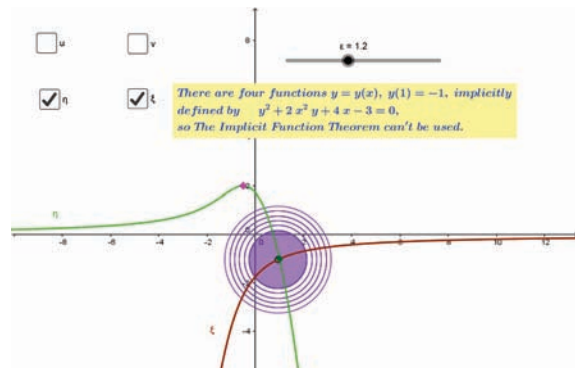

Financed through/by

- S.C. PRO AIR CLEAN ECOLOGIC S.A., Timișoara

Research team

Assoc. Prof. Dr. Doru Păunescu

Contact information

Assoc. Prof. Doru PĂUNESCU, PhD
 Department of Mathematics
 Address: Piata Victoriei No. 2, RO300006, Timisoara
 Phone: (+40) 256 403 099
 Mobile: : (+40) 744 477 468
 E-mail: doru.paunescu@upt.ro
 Web: <http://www.mat.upt.ro/> and <http://geogebra.upt.ro/>

Patents

INVENTOR: MIRCI LIVIU EDUARD

PATENT NO. 129562/2015

SEBACIC SYNTHETIC LUBRICANTS AND PROCESS FOR PREPARING THE SAME



The invention relates to a synthetic lubricant and to a process for preparing the same. The claimed lubricant has the formula $R-OOC-(CH)_2-COO-R-OOC-(CH)_2-COO-R(I)$ where R is a radical resulting from glycol and Ris an isotridecyl radical.

The claimed process consists in reacting a mole of glycol with two moles of sebacic acid in the presence of an aromatic solvent, in a usual catalyst system, after which the reaction mixture is brought at the reflux, when the reaction water is extracted, followed by cooling the reaction mass, adding two moles of isotridecanol, extracting the reaction water, removing the solvent and treating the resulting material for bleaching with activated coal and filtering, wherefrom there is obtained a lubricant with a viscosity index of 137...176, flammability point of 248...285 DEG C and a wear spot diameter of 0.50...0.70 mm.

Utility Models

INVENTORS: PAVEL STEFAN, BORZA IOAN, BRATU EMANUEL ADRIAN, DOBOSI IOAN SILVIU, GAINA PAULINA IOANA, STREIAN FELICIA, TALPOS-NICULESCU SERBAN
UTILITY MODEL NO. RO201300033

LIGHTING INSTALLATION FOR THE "CERAMICS ROOM" COMPARTMENT IN DENTAL LABORATORIES



The invention relates to a lighting installation to be used in dental laboratories, in the compartment in which ceramic dental works are prepared.

According to the invention, the installation comprises an assembly of seven lighting fixtures (1) mounted at equal distances on a metal support frame (7) hanging from the room ceiling by means of some rod-type suspension elements (2), above a working table (4), where the distance between the lighting fixtures (1) and the surface of the working table (4) is of 140 cm, an electric control circuit (5) with three switches capable of successive switching, leading to a lighting of 2410 lx suitable for depositing light-polymerizable dental composite onto the dental work, by means of the first switch, a lighting of 2730 lx suitable for depositing ceramic mass onto the dental work, by means of the second switch, a lighting of 4040 lx, suitable for depositing ceramic mass onto the dental work, by means of the third switch, or a lighting of 8880 lx, suitable for fixing the colour of the dental work or for taking dental colour samples from the patient, by simultaneously coupling the three switches, the lighting fixtures (1) being provided with mirror dispersing device, high-performance electronic ballast and fluorescent lamps with a colour rendering index $R_a=94$ and a colour rendering temperature of 5200K.

INVENTORS: PAVEL STEFAN, BORZA IOAN
UTILITY MODEL NO. RO201300050

COMPRESSED-AIR INSTALLATION FOR STOMATOLOGY UNITS



The invention relates to a compressed-air installation of a stomatology unit attending a plurality of dental units at the same time.

According to the invention, the installation comprises a first section including a compressor (1) which supplies a buffer reservoir (2) connected by a T-shaped branch (3) to a pipe (4) supplying a plurality of dental units by means of an electrically-operated valve (5) controlled by an hourly and weekly programming device (6), the said valve (5) being preceded and followed by some closing and opening valves (7 and 8) and distorted by a by-pass circuit provided with a closing and opening valve (9), and a second section which, by the same T-shaped branch (3), via another pipe (11), leads to a plurality of dental units of the emergency room, using a serial assembly consisting of some closing and opening valves (10, 13 and 16), a pressure regulator (12), a pressure gauge (14), a one-way valve (15) and a second T-shaped branch (17) by which a second compressor (18) is connected to the pipe (11) by means of some closing and opening valves (19 and 22), a pressure gauge (20) and a one-way valve (21).

Utility Models Request

INVENTOR: PAVEL STEFAN
UTILITY MODEL NO. R0201300045

PORTABLE DEVICE FOR THE DISINFECTION OF THE AIR AND OF SURFACES IN ENCLOSED ENVIRONMENTS

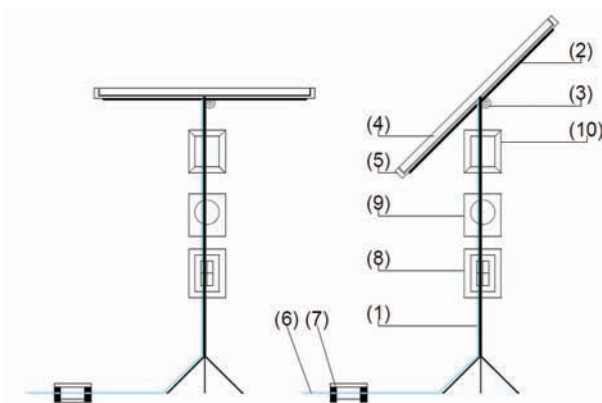

The invention refers to an electrical portable device for the disinfection of the air and of surfaces in enclosed environments such as attics, basements, storerooms, polluted hospital rooms and other spaces without sufficient ventilation or insufficient disinfection by usual means.

The portable device for the disinfection of the air and of surfaces in enclosed environments, according to the invention, is composed of a metal frame (tripod) which has an adjustable peg which provides a range of 00-90°. A fixture designed with a germicidal UV-C lamp with a wavelength of 253.7 nm and UV-C radiation of 15.0 W and permanent electronic ballast and which is protected by a rustproof metal housing with the purpose of protection during transport and reflection during use when mounted vertically on the tripod.

The commissioning of the device for the disinfection of the air and of surfaces is done manually, by way of an electrical switch with a key and by way of an electrical clock with programmable commands.

INVENTOR: PAVEL STEFAN
 UTILITY MODEL NO. R0201300055

PORTABLE DEVICE FOR SIGNALING PAIN, SENSITIVITY OR DISCOMFORT DURING THE COURSE OF MEDICAL DENTAR ACTIVITY

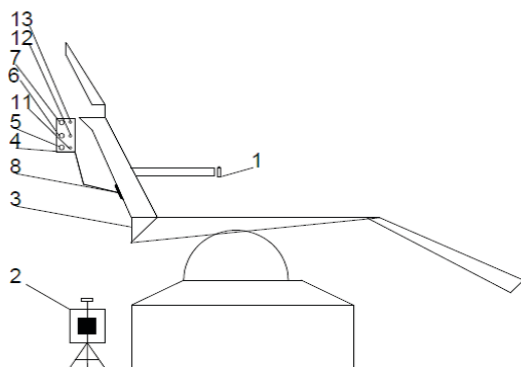

The invention refers to a portable electronic device for signaling pain, sensitivity or discomfort during the course of medical dental activity.

The electrical portable device for signaling pain, sensitivity or discomfort during the course of medical dental activity attachable to the dental unit (armchair) is composed out of an interlocking microcontact piece and/or optionally out of a glove attached to the patient's arm which contains an interlocking piece which is activated manually by the patient in case they feel pain or discomfort during the course of medical dental activity.

The manual activation of the automatically restoring microswitch or of the contacts inside the glove interlocks a relay powered with a tension of 12 V which will command the activation of two independent transformers of 4.5V and 12V which, in turn, will power with electricity, optionally, the operation of a LED lamp, of a buzzer and of a microdiffuser with pre-recorded voice signals installed inside a flexible piece of equipment and attached via a suction cup to the armchair.

This equipment is also designed with microswitches which permit the simultaneous or independent activation of the light signal via the LED lamp, the acoustic signal via the buzzer and the voice signal via the microdiffuser.



Honorary Members

EVOLUTION OF HONORARY MEMBERS OF UPT 2012-2015

The conferring of honorary degrees is one way in which the University recognizes individuals distinguished by accomplishments consonant with the overarching mission of the University.

Nominees may be eminent scholars, scientists, artists, or professionals who have advanced their disciplines in important ways, or they may be individuals outside of the academic world who have made particularly distinguished contributions to society.

Politehnica University of Timisoara recognizes scientific excellence by conferring the honorary degree of Doctor Honoris Causa and Honorary Professor to distinguished Researchers for their contribution to the development of UPT and continuous support.

The University strives for a robust pool of honorary degree recipients enriched by individuals from all backgrounds of engineering.

We also find it rewarding to honor individuals who have not already been publicly recognized by a number of other institutions.

Honorary Members of UPT

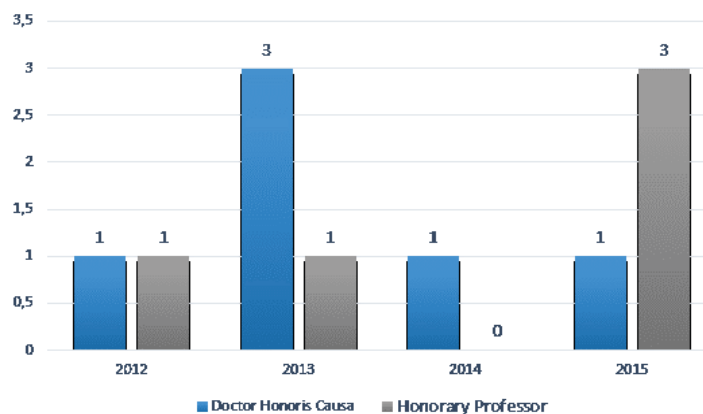

DOCTOR HONORIS CAUSA Professor Traian V. CHIRILĂ – Queensland Eye Institute

Professor TRAIAN V. CHIRILA was born on 14th of February in Arad, Romania. He spent his childhood in Chisineu Cris, Arad County, where he also graduated from high school in 1966. In 1972 he graduates as Bachelor of Chemical Engineering from the Faculty of Industrial Chemistry in Timisoara, in the specialty Technology of Macromolecular Compounds, and in 1981 he is awarded a PhD in chemical sciences by the same faculty. After obtaining his PhD degree, he accepted to go as a specialist in polymers processing to a country in North Africa, Libya. In December 1982 he reaches Austria where he asks for political asylum, and then he waited for seven months until Australia accepted him as a political refugee and relocated him to Perth, Western Australia, where he spend the next 22 years.

Professor TRAIAN V. CHIRILA, BEng, PhD, is the Chief Scientist of the Queensland Eye Institute in Brisbane, Australia, and Honorary Professor at Queensland University of Technology, the University of Queensland (at the Australian Institute for Bioengineering and Nanotechnology), and the University of Queensland (at the Faculty of Medicine and Biomedical Sciences).

Professor Traian V. Chirila is the inventor of the AlphaCor™ artificial cornea (initially known as the “Chirila keratoprosthesis”) and of the AlphaSphere™ orbital implant, both currently in clinical practice. He and his colleagues at Queensland Eye Institute were the first to investigate and report the use of silk proteins as biomaterials in ophthalmic tissue engineering.

Professor Chirila’s scientific activity has been widely recognized internationally. He is a member of Australasian Society for Biomaterials and Tissue Engineering, New York Academy of Sciences and American Chemical Society. Also, he is a member of the editorial boards of 11 scientific journals. In 2002, he was awarded Diploma of Excellence of the Euro-Asia Promotion & Cultural Foundation, and in 2014 he received the SRB Excellence Award from the Romanian Society for Biomaterials. He also became an Emeritus Member of the Politehnica Foundation.



The results obtained by Professor Chirila are in diverse research fields including polymer science, hydrogels, ophthalmic biomaterials, ophthalmic tissue engineering and regenerative medicine, supramolecular polymers, controlled release of bioactive agents, and history of science. His contributions to the science of biomaterials are recognized by all those working in this field and his name is forever linked to his contributions to ophthalmology and prevention of blindness. His scientific activity is not limited to the applications of polymers in ophthalmology. Professor Chirila has investigated the interaction between high-energy laser radiation and polymers; he invented and developed melanin-containing synthetic hydrogels, which are able to absorb UV and blue radiation; he has investigated the mechanism and prevention of spontaneous calcification of synthetic hydrogels and he demonstrated that the enforced formation of polymer interpenetrating networks (IPNs) can reduce calcium deposition; he developed a new concept for an artificial corneal endothelium; and other research projects. Most of the projects are intended to ultimately contribute to the worldwide efforts to eradicate blindness. The results of his work are presented in about 180 articles and book chapters, over 180 presentations at scientific gatherings, and 13 patents.

HONORARY PROFESSOR

Professor Jean Pascal CAMBRONNE - Université "Paul Sabatier" de Toulouse, France

Professor Jean Pasacal CAMBRONNE was born on 31.03.1963 in France and graduated "Ecole Central de Lille" in 1987. PhD Studies have been performed during 1988–1990 at "Ecole Central de Lille". PhD degree has been acquired in 1990.

In 1991 he becomes associate professor at "Ecole Central de Lille". In 1996 he gained the habilitation certificate and the quality to supervise PhD thesis. In 1997 he became professor at "Paul Sabatier" University Toulouse, where he also activates as researcher at LAPLACE Laboratory affiliated at C.N.R.S. Starting with 01.09.2012 he was evaluated as exceptional activity and he received a P.E.S. prize (Prime d'Excellence Scientifique).

Considering his recognized international professional prestige, during years, he held important professional positions:

- director of the GDR research group from C.N.R.S., comprising over 400 researchers from the Electrical Engineering field;
- expert of the "Agence de l'Evaluation de la Recherche et de l'Enseignement Supérieur (section Formation & section Recherche)";
- expert of the "Fondation pour la Recherche en Aéronautique et Espace";
- supervisor / director of the research team "Matériaux Diélectriques dans la Conversion de l'Energie", from the LAPLACE Laboratory of the "Paul Sabatier" University Toulouse, France;
- member of the "Comité National de la Recherche Scientifique – section 8", between 2008–2011 years;
- deputy director of the "Fédération de Recherche FERMAT", between 2007–2010 years;
- president of the "l'Agrégation de Physique Appliquée", between 2007–2012 years;
- manager of the master study program "Researches in electrical engineering", from "Paul Sabatier" University Toulouse.

Outstanding quality of the didactic activity

- Prof. Jean Pascal CAMBRONNE conducted a remarkable activity during his didactic career. He taught a number of 8 different disciplines from the electrical engineering field in French and in English. During his didactic career he followed all the hierarchical steps collaborating with different universities from Europe.
- Prof. Jean Pascal CAMBRONNE initiated in the engineering secrets 20 generations of graduates.
- He taught lectures and laboratory works from several disciplines: power electronic and electrical machines (Bachelor study cycle); energy static and electromechanical conversion (Master study cycle); electrical machines modelling (Master study cycle); insulation materials, magnetic materials, superconducting materials, piezoelectric materials used within the electrical engineering field (Master study cycle).



Scientific activity and professional recognizing

- Prof. Jean Pascal CAMBRONNE has also a remarkable activity within the scientific publishing area. He has a large number of publications with huge consistency proved by their professional level and the prestige of the publishing houses that published them.

The published works are mentioned in synthesis as follows:

- 27 papers published in international journals;
- 3 patents;
- 50 papers presented at international conferences;
- 3 monographs, books and lectures;
- 20 grants / research contracts;
- 20 PhD thesis supervised

Collaborations with Politehnica University Timisoara

During his professional career, Prof. Jean Pascal CAMBRONNE had several collaborations with professors from the Faculty of Electrical and Power Engineering, from Politehnica University Timisoara.

HONORARY PROFESSOR

Professor Franz QUINT- Karlsruhe University of Applied Sciences, Germany

Professor Franz QUINT was born on 24.08.1965 in Jimbolia, Romania. Professor Franz Quint began his studies in Timisoara, at Politehnica University, Electrical Engineering Faculty (1984 – 1986) , and has continued the studies at Karlsruhe Institute of Technology, Germany (1987 – 1990).

Nowdays, Franz Quint is full professor for Digital Communications since March 2002 in the Faculty for Electrical Engineering and Information Technology, at Karlsruhe University of Applied Sciences.

Professional Experience:

Karlsruhe University of Applied Sciences, 2002 -

- Appointed as full professor for Digital Communications since March 2002 in the Faculty for Electrical Engineering and Information Technology

Research interests:

- Information Theory and Coding
- Digital Signal Processing
- Digital Image Processing
- Digital Communications

Airbus, 1997 - 2002

- 1997 – 2002 development engineer at DaimlerChrysler Aerospace in Ulm, Germany (today Airbus) in the areas of Digital Communications, COMINT and Radar Signal Processing
- leader of project teams, since 1999 head of the department “Digital Signal Processing Algorithms”

Karlsruhe Institute of Technology, KIT, 1993 - 1997

- 1993 – 1997 researcher on a project of the DFG (German federal research agency) for automatic aerial image understanding
- 1997 PhD-thesis „Kartengestützte Interpretation monokulare Luftbilder“ (Map-based interpretation of monocular aerial images), awarded degree: Dr.-Ing. with summa cum laude

Fraunhofer-Institute for Information- and Data-Processing Karlsruhe, 1990 - 1993

- 1990 – 1993 researcher
- projects on industrial image processing and aerial image understanding

Collaborations with Politehnica University Timisoara

The cooperation between UPT and HsKA dates back to the year 2008. In May 2008, a delegation of HsKA consisting of Prof. Guntram Schultz, by then dean of the Faculty of Electrical Engineering and Information Technology of HsKA, Dr. Joachim Lembach, Director of the International Office of HsKA and Prof. Dr. Franz Quint, professor at the Faculty of Electrical Engineering and Information Technology, visited UPT. The visit was initiated by Prof. Quint, who was student at UPT in the years 1984-1986.



During the visit, meetings of the German delegation with the Rectorate and with the boards of the Faculty of Electronics and Telecommunication and the Faculty of Electrical and Power Engineering took place. As a result, an Erasmus student and staff exchange agreement and a bilateral agreement between the two higher education institutions has been signed. These agreements have been renewed in 2014.

Since then, counting both exchange directions:

- 180 students participated in project based learning in the project ProKaTim (Signal Processing Karlsruhe Timisoara);
- 48 students spent one semester at the partner institution for an Erasmus study semester abroad;
- 9 students spent three months in an Erasmus training stage at the partner institution;
- 9 research assistants spent research stages up to eighteen months at the partner institution;
- 4 research assistants have acquired their doctoral degree with the participation of professors from both institutions;
- 20 scientific papers have been published in cooperation between researchers of both universities;
- 29 teaching staff exchanges took place;
- 7 non-teaching staff exchanges took place;
- the cooperation employs 6 faculties from UPT, 4 faculties from HsKA and is strongly supported by the International Offices and the Rectorates of both Universities.

HONORARY PROFESSOR

Professor Francisc KLEPP – Politehnica University of Timisoara

Professor Francisc Klepp was born on 23 October 1940 in Timisoara, Romania. He followed Elementary classes (1947-1954) in Timisoara Joseph's Catholic Secondary School, and in 1957 he graduated "magna cum laude" from Timisoara Hungarian Mixed High School as a student with all excellent. Prof. Klepp graduated in 1963, the Politehnica University of Timisoara, Faculty of Mathematics and Mechanics, with excellent results, so immediately after graduation he was received as assistant professor. The PhD Thesis, Remarkable Finsler Structures and Finsler Geometry on Vector Bundles", was defended in 1982, at "Al. I. Cuza" University from Iasi. Currently, Professor Francisc Klepp live in Germany, Mosbach, the Neckar valley.

- Between 1963 and 1993 he worked at Politehnica University of Timisoara, Mathematics Department, first as an assistant professor, then from 1968 as associate professor, and since 1990 as professor holds Applied Mathematics courses in chemical engineering.
- Since 1990 the department of Mathematics established the courses in German-language, and Professor Klepp taught mathematics in German. In the same period, he lectured at foreign universities: Debrecen, Veszprem and Novi Sad.
- In November 1993, Professor Francisc Klepp moved in Germany. Here, between 1994 and 2013 was Professor for "Mathematics for Engineers" in Lörrach Electrical Engineering and Informatics Faculties. He taught mathematics and physics in Schopfheim Theodor-Heuss-Gymnasium. Parallel teacher training courses are held in Universities: Bazel, Karlsruhe, Freiburg and Hannover.
- In 2013, after fifty years of activity he retired.
- A passionate sports fan, he was vice president of the Politehnica Timisoara Sports Club men's handball, between 1982 and 1993.

Professor Francisc Klepp is a member of the following professional company:

- János Bolyai Mathematical Society – Budapest (since 1989);
- Mathematical Society Science from Romania (1961);
- Tensor Society (Japan – since 1985);
- Internatinal Mathematical Society for Chemistry (since 1985);
- Deutsche Gesellschaft für Chemisches Apparatewesen (DECHEMA – since 1990);
- Gesellschaft für Angewandte Mathematik und Mechanik (GAMM – since 1991);
- Gesellschaft Deutscher Chemiker (since 1991);
- Hungarian Natural History Society (since 1991);
- Transylvanian Museum Society [5] (EME, 1990), a founding member;
- Ormós Zsigmond Cultural Society, Timisoara (the 1968 Small Encyclopedia of the Free University successor)



Awards:

- In 1987, Prof. Klepp was assessed by Romanian Government for scientific, didactic, and educational work, with degree the "excellent teacher".
- At Politehnica University of Timisoara Professor Francis Klepp won 28 different awards at applied mathematics contests.

Professor Francisc Klepp attended countless professional congresses, conferences in:

- Romania: Iasi, Cluj, Oradea, Brasov, Targu Mures, Arad, Bucharest, Constanta, Craiova;
- Hungary: Budapest, Debrecen, Veszprem, Hungary, Sopron, Miskolc, Nyíregyháza, Szolnok, Zalaegerszeg, Szeged, Eger;
- Germany: Karlsruhe, Hannover, Dresden, Freiburg, Darmstadt, Erlangen, Stuttgart, Heidelberg, Göttingen;
- Switzerland: Basel, Zurich, Lausanne;
- Austria: Vienna, Linz;
- Serbia: Novi Sad;
- Croatia: Zagreb;
- Canada: Windsor, Ottawa, Waterloo.

Habilitation Thesis

EVOLUTION OF HABILITATION THESIS IN UPT 2012-2015

Habilitation (from Latin *habilis* "fit, proper, skillful") is the highest academic qualification a scholar can achieve by his or her own pursuit.

In this chapter we present the habilitation thesis supported by teachers from Politehnica University of Timișoara, both at UPT and, also, at other universities.

The habilitation thesis are presented in alphabetical order, according to institution where they were sustained.

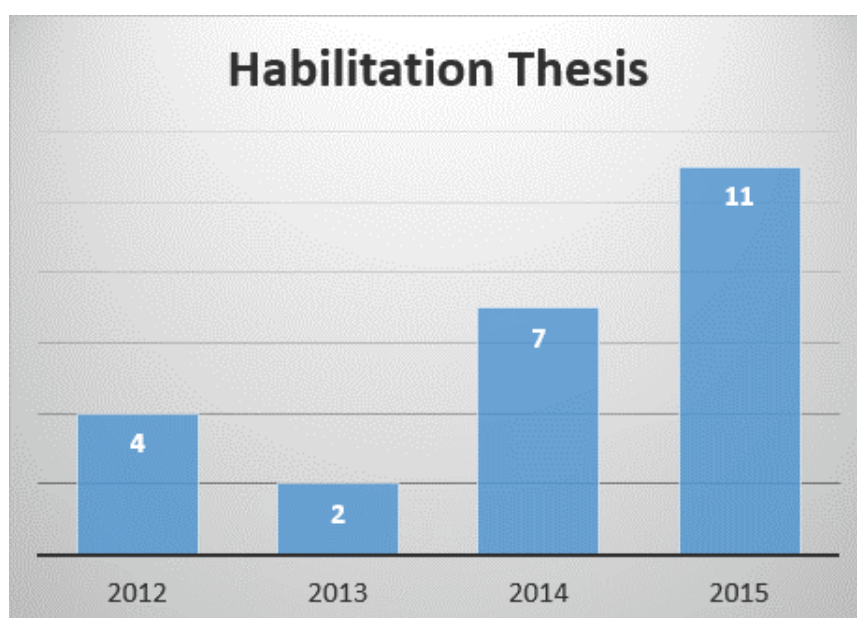

COMPUTATIONAL INTELLIGENCE PARADIGMS WITH APPLICATIONS IN EMBEDDED VISION

Author: Cătălin-Daniel CĂLEANU

Abstract

The first part of the thesis is constituted by the abstract versions.

The second part of the thesis refers to the:

- Overview of activity, in which it's presented the most prominent research, professional and academic achievements (list of publications and grants classified in four main research topics, newly introduced disciplines, taught courses, contribution to the development of the academic curricula, invited professor, students internship, conducting diploma and dissertation theses, endowed laboratories and library, international cooperation, management activities, etc.).

- The most important mentioned aspects are: a number of 53 research articles published in the above mentioned period, 12 research grants (7 as grant/contract director) and 6 books.

- Technical presentation in which four main research topics are identified:

Computational intelligence in autonomous mobile robotics. First work presented here is interested in environment representation which permits the robot to know if it goes in the right direction by acquiring a spatial models of the robot's physical environment using a non-metric/qualitative approach. Second work presented within the framework of the above mentioned topic deals with genetic algorithm based methods for finding optimal structure for a neural network (weights and biases) and for a fuzzy controller (rule set) to control a group of mobile autonomous robots. The goal of the robots, namely catching the targets, could be fulfilled only through an emergent social behaviour observed in our experimental results.

Artificial intelligence paradigms for human face identification. Previous works has shown that Gabor feature extraction is one of the most effective techniques employed for the human face recognition problem. The authors propose an alternative feature extraction method - the Interest Operator - to be applied for the facial recognition problem.

Soft computing based face expression recognition. The aim of the first presented work is to identify key representative approaches for facial expression recognition research in the past ten years (2003-2012). The interest in creating such an overview is multifarious. Moreover,



this selection can be a useful indicator of the areas that will constitute the future research trends. The second detailed work concerns a layered fuzzy facial expression generation of a virtual agent. In this model, social, emotional and physiological layers contribute to the fuzzy facial expression generation.

3D biometrics. In the first work, using combined skeletal tracking and depth information, a biometric person identification is performed. All these features are provided by a low cost 3D acquisition system, the Kinect sensor [Kinect12].

The full abstract at:

http://www.upt.ro/img/files/2014-2015/doctorat/abilitare/caleanu/Rezumat_teza_Caleanu_en.pdf

Habilitation Commission

Prof.univ.dr.ing. Silviu CIOCHINĂ
Universitatea Politehnică din București;
prof.univ.dr.ing. Ioan NICOLAESCU
Academia Tehnică Militară din București;
Prof.univ.dr.ing. Alexandru ISAR
Universitatea Politehnica Timișoara.

SUSTAINABLE DESIGN OF SEISMIC RESISTANT STEEL AND COMPOSITE BUILDING STRUCTURES

Author: Adrian Liviu CIUTINA

Abstract

The present thesis summarizes the most important part of the research activity of the candidate after defending the PhD Thesis. The selected activity was considered to be relevant in terms of originality and importance, in order to anticipate an independent development of the further research and teaching career.

The post-doctoral activity is addressed in two main thematic directions developed by the candidate:

- (i) Seismic Behaviour of Steel and Concrete Composite Structures presented in Chapter 2 below and respectively
- (ii) Sustainable Development of Buildings, presented in Chapter 3.

Continuing the main theme of the Ph.D. thesis – seismic behaviour of composite structures, the candidate obtained by competition a research grant (name of the grant: “Numeric and Experimental Study on the Connecting Devices between Steel and Concrete for Composite Buildings” Located in Seismic Zones) soon after his Ph.D. defence, offered by the Romanian Ministry of Education and covering the seismic behaviour of connecting devices between steel and concrete in composite elements.

Following another subject touched in his Ph.D. thesis, the candidate explored the dissipative zones in steel and steel and concrete composite frames. Based on the previous experimental and analytical work, not entirely developed in the Ph.D. thesis, the candidate published several papers on the ductility of Column Web Panel Zone, among which two on ISI indexed journals. Other dissipative zones of steel and composite frames included the joint zones for Moment Resisting Frames (MRF) and link elements in case of Eccentrically Braced Frames (EBF). The research was conducted mainly by integration of the candidate into two Romanian research grants.

Following the investigation of the dissipative zones of frames, the implications on the structural response were investigated in a series of studies mainly within the same research grants as mentioned before. The structural response in the case of important seismic motions depends directly on the elasto-plastic behaviour of elements and hinges. The numerical investigation considered elasto-plastic analyses of low and medium height steel frames, considering the interaction of the steel beam with the concrete slab,



The second subject of research covered by the candidates is related to the Sustainable Development of Buildings. The subject as developed by the candidate after his integration in the team of the international grant COST C25 (2006-2010) type TUD COST C25 “Sustainability of Constructions - Integrated Approach to Life-time Structural Engineering”. There are two main themes addressed by the candidate in the topic of sustainable development of buildings: (i) approach for new steel-intensive structures and respectively (ii) sustainable retrofitting solutions for existing building stock. The sustainable retrofitting solutions for existing building stock represents one of the issues of large interest in Romania: in this moment more than one third of the Romanian population lives in about 84000 block of flats (apartment house type) built between 1960 and 1990 with important issues to be reviewed.

The full abstract at:

http://www.upt.ro/img/files/2014-2015/doctorat/abilitare/ciutina/Rezumat_teza_Adrian_Ciutina_EN.pdf

Habilitation Commission

Prof.univ.dr.ing. Valeriu STOIAN
Universitatea Politehnica Timișoara;
Prof.univ.dr.ing. Cosmin CHIOREAN
Universitatea Tehnică din Cluj-Napoca;
Prof.univ.dr.ing. Federico MAZZOLANI
Universitatea „Federico II” Napoli, Italia.

GEOMATICS - IMPACT ON URBAN PLANNING, ENVIRONMENT AND SOCIETY

Author: Carmen GRECEA

Abstract

Present thesis summarises the main domains for research activity of the candidate after defending the PhD Thesis at Technical University of Civil Engineering in Bucharest, Faculty of Geodesy, in 1999.

On the basis of this diploma I was awarded the scientific title: Doctor of Technical Science, branch Science and Technology, for the doctorate field: Geodesy, Photogrammetry, Cartography and Remote Sensing.

The content of the habilitation thesis is defined on three sections: A. Abstract; B. Scientific, professional and academic achievements; C. Proposal for the future academic, scientific and professional career development.

The research activity and achievements presented are developed in two main thematic directions:

- Implementation of new technologies and techniques for Cadastral applications with geo-information support in relation with environment protection, which continues and diversify with new subjects, the topic of the PhD Thesis.
- Implementation of geo-information bases for Urban Planning purposes, society needs and sustainable geodesy, being rather a new field of research.

My activity in this field is related to the research of the National Geodetic School correlated with the national policies in the domain, and lately, connected also to European trends.

The results of my scientific research are materialized mainly in specialty scientific articles and books. Therefore, I have always focused on this aspect, considering that not only the quantitative aspect of the work is important, but also the quality and the value of the material published.

Another challenge was the decision of choosing the correct research directions in correlation with the existent financial, materials and mainly human resources. At present time, my research activity tends to be multidisciplinary, involving specialists in civil engineering, environment, architects, experts in information technology, researchers in the field of geosciences, etc.

This multidisciplinary cooperation, the contact with specialists from different research fields within the research teams I was a member of, have represented for me an important qualitative improvement.



The collaboration has contributed to my training and my development from the professional and scientific point of view.

For future activities I intend to develop researches in new fields of activities which require geodetic support, such as:

- application of the terrestrial laser scanning for environmental processes and changes
- geodetic facilities to investigate the Earth's crust movements
- creating 3D models of heritage objects using image processing
- using geographic information system and spatial database technology in analysis and management of risk areas
- challenges in implementing the systematic land registration in Romania in relation with European standards

The full abstract at:

http://www.upt.ro/img/files/2014-2015/doctorat/abilitare/grecea/3_Rezumat_teza_abilitare_Carmen_Grecea_en.pdf

Habilitation Commission

Prof.univ.dr.ing. Johan NEUNER
Universitatea Tehnică de Construcții București;
Prof.univ.dr.ing. Dumitru ONOSE
Universitatea Tehnică de Construcții București;
Prof.univ.dr.ing. Dan RĂDUCANU
Academia Tehnică Militară București.

RESEARCH AND ACHIEVEMENTS IN REAL-TIME AND EMBEDDED SYSTEMS, INTELLIGENT SENSOR NETWORKS AND ROBOTIC ENVIRONMENTS

Author: Mihai Victor MICEA

Abstract

During over 17 years of academic and research activity, the author has gained a rich expertise in the following fields of interest: real-time and embedded hardware/software systems, digital measurement and instrumentation, digital signal processing and multimedia, wireless sensor networks, digital telecommunication systems, collaborative robotic environments, and energy-efficiency and power management mechanisms. In these fields, he published over 89 scientific works, out of which, 8 articles appeared in high ranked journals indexed by the Thomson ISI database with impact factors, 20 papers in ISI-indexed proceedings of international conferences, and 22 works are indexed in other international scientific databases. The ISI-indexed papers cumulate a total impact factor of 11.978. The published works are cited by more than 62 papers published by other authors, out of which 28 are ISI-indexed. The activity has been recognized by the academic and scientific community through several awards, distinctions and prizes, such as the Eminent Young Researcher of Timisoara Prize and Medal, from the National Authority for Scientific Research (ANCS), Romania, the Eminent Researcher Prize, from the Orizonturi Universitare Association, Timisoara, and a total of 8 prizes, won at 11 editions of the International Computers Contest for Students, "Hard&Soft" Suceava, as coach or advisor of the teams of students.

In Chapter 2 are presented some of the most relevant post-doctoral contributions to the field of real-time and embedded systems are presented. Advances and results, obtained by the research team in the field of intelligent sensor networks, are described in Chapter 3. The CORE-TX (Collaborative Robotic Environments – The Timisoara Experiment) platform has been designed and implemented at prototype level, for the study and development of real-time systems, distributed artificial perception applications, intelligent sensor networks and collaborative robotic environments

In the field of collaborative robotic environments, several important contributions of the research team are discussed in Chapter 4.



A collaborative robotic alignment algorithm has been developed as the first stage of some more complex robotic location management procedures. Chapter 5 covers some of the main contributions to the field of energy efficiency and power management techniques

The full abstract at:

http://www.upt.ro/img/files/2014-2015/doctorat/abilitare/micea/Habilitation_Thesis-Abstract_Micea.pdf

Habilitation Commission

Prof.univ.dr.ing. Nicolae ȚĂPUȘ
Universitatea Politehnică din București;
Prof.univ.dr.ing. Sergiu NEDEVSCIHI –
Universitatea Tehnică din Cluj-Napoca;
Prof.univ.dr.ing. Lucian VINȚAN –
Universitatea "Lucian Blaga" din Sibiu.

DEVELOPMENT OF SIMULATION TOOLS FOR DISTRIBUTED ENERGY CONVERSION SYSTEMS TOWARDS SMART GRIDS

Author: Nicolae Lucian MIHEȚ-POPA

Abstract

The Habilitation Thesis points out the main research that the author has been performed, during the last ten years, in the area of Energy Conversion Systems with Renewable Energy Resources and Battery Storage Solutions. It is based on original contributions performed during the research activities financed by POLITEHNICA University of Timisoara, Aalborg University-Denmark, Siegen University-Germany, The Danish National Laboratory-RISO and Technical University of Denmark (DTU). The work made in this thesis has been funded by 7 international grants/projects and by 4 national (CNCSIS) grants, as well. Based on the obtained results have also been published more than 70 papers, in national and international journals and conference proceedings, 10 books and 6 research reports.

The first part of the Habilitation Thesis, regarding scientific and professional achievements, contains 5 chapters. The first chapter gives an overview of the research roadmap of the thesis, pointing out the objectives, the main contributions, research grants and awards. The aim of the second chapter was to develop simulation models of DER components in Power System, using two dedicated software packages MATLAB/Simulink and DlgSILENT PowerFactory. The third chapter is dedicated to control strategies developed for renewable energy systems in a distribution network. The Chapter four is focuses on testing of Distributed Energy Resources (DER) components and systems with storage devices and actively controlled loads and also on electric vehicle batteries testing to study the impact of smart charging and fast charging on the power system and on the battery degradation. Two different types of EV battery packs have been tested. The purpose of the Chapter 5 was to design a distribution network with different DER Components connected along the feeders and to identify limitations of existing simulation and planning tools, with a particular focus on the challenges imposed by the introduction of Smart Grid technologies.



The second part of the Thesis, regarding to future plans for advancement and career development, is based on the proven skills to conduct and coordinate high-level research and teaching activities at academic level and to initiate successful international collaborations in the field of renewable conversion systems

The full abstract at:

http://www.upt.ro/img/files/2014-2015/doctorat/abilitare/mihet/Rezumatul_Tezei_abilitare_engleza_LucianMihet.pdf

Habilitation Commission

Prof.univ.dr.ing. Mihai Octavian POPESCU
Universitatea Politehnica din București;
Prof.univ.dr.ing. Călin MUNTEANU
Universitatea Tehnică din Cluj-Napoca;
Prof.univ.dr.ing. Mircea RĂDULESCU
Universitatea Tehnică din Cluj-Napoca.

BEARING STRUCTURES IN ARCHITECTURE. PAST, PRESENT AND FUTURE

Author: Marius MOȘOARCĂ

Abstract

The author began his research activity with the elaboration of the diploma work in 1994, under the scientific coordination of Prof. Valeriu Stoian in the domain of anti-seismic design of structures with reinforced concrete walls.

In 1998, the author started his collaboration with Prof. Dr. H.C. Victor Gioncu, as an assistant within the Faculty of Architecture and Urbanism from Timisoara. Under the scientific coordination of Prof. V. Gioncu, the author performed research, design and didactic activities in the design and consolidation domain of reinforced concrete, steel, masonry and timber bearing structures subjected to different types of actions.

Research domains in which the author brought innovative theoretical contributions after the completion of his PhD thesis:

Reinforced concrete structural walls. Personal contributions: explanation of the brittle failure mechanisms developed by the walls with ordered vertical openings based on recordings of the acceleration component and speed of the seismic waves measured in the field and in buildings;

Historic masonry bearing structures. Personal contributions: development of calculation methodologies specific for the failure modes of mosques, synagogues and orthodox churches, within the PROHITECH research program, based on the theory of failure blocks;

Reinforced concrete frame structures with masonry infills. Personal contributions within the INSYSME research program: identification of the failure modes of these structures and the proposal of new technologies for the increase of the bearing capacity of these infill walls subjected to out-of-plane solicitations;

Timber framing systems. Personal contributions within the COST FP1101 research program: identification of new types of timber framing systems, consolidation solutions, in-situ investigations, failure mechanisms and development of a methodology for their vulnerability assessment;

Steel bearing structures. Personal contributions: investigation of the influence of the cyclic loading type and of the loading speed on the local and global ductility of steel frames as well as on the steel elements and connections;



Seismic vulnerability of historic centres. Personal contributions: studies performed on individual buildings and aggregates of buildings from Timisoara;
Research and development of new ways of teaching structural design in architectural schools.

Published articles by the author: 103; 12 in ISI journals, 14 ISI proceedings, having 18 citations in ISI journals and 12 in ISI conferences; 1 published book, co-author for 3 international books, associate editor for 1 international book; 2 courses and 2 practical guides. The author has participated in 3 international research grants, among which 2 as coordinating director for Romania, and in 4 national research grants.

The full abstract at:

http://www.upt.ro/img/files/2014-2015/doctorat/abilitare/mosoarca/01_Habilitation_Thesis_Marius_Mosoarca.pdf

Habilitation Commission

Prof.univ.dr.ing. Dan DUBINĂ
Universitatea Politehnica Timișoara;
Prof.univ.dr.ing. Cosmin CHIOREAN
Universitatea Tehnică din Cluj-Napoca;
Prof.univ.dr.ing. Federico MAZZOLANI
Universitatea „Federico II” Napoli, Italia.

CONTRIBUTIONS TO THE OPTIMAL STRUCTURES OF THE ELECTROMECHANICAL SYSTEMS AND THE ELECTRIC POWER QUALITY

Author: Sorin MUȘUROI

Abstract

The habilitation thesis presents the most important professional and scientific results obtained by the author during 2001–2014. This period follows the public presentation of his doctoral thesis, which took place in 2000.

Three main research areas have been addressed: The optimal design of AC motors, the optimal control of electrical drives with AC motors and Single-phase power factor correction converters. The thesis is structured in five sections.

The first section presents the achievements and results in the author's career.

The second section is devoted to the optimal design of AC motors. The first part of this section presents a selection of results obtained by the author in the study of skin effect that manifests in the high rectangular rotor bars of the induction motor fed by a voltage inverter. This study aims to develop a theory of asynchronous motor, under non-sinusoidal power regime, leading to the optimization of the methodology of the constructive / technologic design, under favorable economic conditions.

The second part of this section is devoted to promote a new concept of an economically advantageous design of the synchronous motors. For this purpose, the paper proposes three new topologies of rotors for the synchronous machine. All the solutions studied aim a much cheaper alternative to the synchronous motors with rare earth permanent magnets.

The third section is devoted to the Optimal control of electrical drives with AC motors. The first part of this section presents the results obtained from the implementation of vector control directly in torque and flux for the electric drive systems of marine mechanisms. The second section presents the results of the practical implementation of the algorithms for controlling the AC motors fitting the reversible driving systems, characterized by a wide range of speeds.



The fourth section presents a summary of the research results obtained in the field of single-phase power factor correction converters.

The study analyzed the following power factor correction converters: the boost converter, the interleaved boost converter, the bridgeless converter and the bridgeless interleaved converter.

The full abstract at:

http://www.upt.ro/img/files/2014-2015/doctorat/abilitare/musuroi/Abstract_teza_Musuroi_Sorin.pdf

Habilitation Commission

Prof.univ.dr.ing. Mihai Octavian POPESCU
Universitatea Politehnica din București;
Prof.univ.dr.ing. Florin IONESCU
Universitatea Politehnica din București;
Prof.univ.dr.ing. Călin MUNTEANU
Universitatea Tehnică din Cluj-Napoca.

HABILITATION THESIS

Author: Corina-Alda Naforniță

Abstract

My activity is carried out in the framework of the Intelligent Signal Processing Adelaida Mateescu Research Centre. My research interests include: signal & image processing, statistical signal processing, watermarking, wavelets, radar signal processing. This thesis covers the research activities published in the period 2008–2014. My research efforts in image watermarking, my PhD thesis field, were continued. I have co-authored a paper that presents the implementation of a new transform, the Hyperanalytic wavelet transform, HWT, used for watermarking and denoising with a better performance than other quasi shift-invariant complex transforms. A research preoccupation was the statistical analysis of wavelet transforms. I improved the directional selectivity of the HWT using Hyperanalytic Wavelet Packets Transform. I have improved the Hurst exponent estimation techniques by applying a LASSO based regularization in the wavelet domain and I applied this estimation method to solve an image denoising problem where the regularity is considered to vary piecewise.

We have considered the HWT coefficients being circularly distributed, with complex Gaussian distribution. We computed a closed form for the Kullback-Leibler divergence for the Complex Generalized Gaussian Distribution (CGGD).

A new method for texture clustering based on the barycentric distribution is proposed. These activities were carried out in the framework of an international research project Brancusi, funded by UEFISCDI and EGIDE, for which I was grant director on the Romanian side. The grant director on the French side was Professor Yannick Berthoumieu, ENSEIRB MATMECA, Bordeaux, France. Recently, in the framework of an European Project (FP7-ARTRAC), I have worked in the field of RADAR signal processing, proposing denoising to improve the probability of detection for the envelope detector; as well as a method to build the range-Doppler map for multiple targets in the automotive field.



I am reviewer and TPC member for prestigious journals and international conferences. In April–June 2011 I was invited researcher at Lab. Intégration du Matériau au Système, Bordeaux and in Sept–Oct. 2009 I was Invited Professor, at the same laboratory, where I was awarded an EGIDE scholarship for research (Oct. 2009).

The full abstract at:

http://www.upt.ro/img/files/2014-2015/doctorat/abilitare/naformita/6Teza_abilitare_cu_coperta_NafornitaCorinaAlda.pdf

Habilitation Commission

Prof.univ.dr.ing. Silviu CIOCHINĂ
Universitatea Politehnică din București;
Prof.univ.dr.ing. Ioan NICOLAESCU
Academia Tehnică Militară din București;
Prof.univ.dr.ing. Radu VASIU
Universitatea Politehnica Timișoara.

OPTIMIZING THE PROJECTS AND PROCESSES MANAGEMENT IN THE FIELD OF INDUSTRIAL ENGINEERING. USING ARTIFICIAL INTELLIGENCE METHODS

Author: Titus SLAVICI

Abstract

The habilitation thesis reflects the activity of the author, performed after graduated the both PhD and 2014. It is based on original contributions performed during research activities at Politehnica University of Timisoara, West University of Timisoara, "Ioan Slavici" University of Timisoara, and also in other universities (inside the partnership and stages in Szeged, Novi-Sad and Nyregyhaza).

The thesis combines the two fields of expertise (engineering and inside computers applied in industrial engineering and economic and inside management and finance), mainly concerned by graduating from more specializations .

1. Industrial engineering (machine buiding technology) license – Politehnica Timisoara University 1983
2. Automatics and computer license –Politehnica Timisoara University1994
3. Finances license – West University Timisoara -2000
4. Management license – West University Timisoara 2001
5. Industrial engineering doctorate – Politehnica Timisoara University –“Contribution to computer aided design of machine-tools with numerical control in order to manufacturing complex geometrical entities” PhD Thesis 1994
6. Finance doctorate – West University Timisoara – „Financial management optimization using artificial intelligence methods”, PhD Thesis, Timisoara, 2006.

These are part of the fundamental basic training, continuously improved through complementary trainings and educational programs.

The plan for advancement and career development is based on the proven skills to conduct and coordinate high-level research and teaching activities at academic level and to initiate successful international collaborations in the field of using computers tools in economic.

A complex educational and research system, developed based on national and international research grants will provide an ideal platform to train and educate graduate as well as undergraduate students in an almost unique multidisciplinary exploration topic, involving computer science and also economic field, creation of sustainable collaborative mechanisms with national and international



partners in the field of decision is a priority of the research group. The results are planned to be valorized in the scientific community, but also to be oriented towards the public interested in the subjects of the research activity.

In summary, based on the activity developed so far, an extended set of activities at local, national and international level are foreseen; the results could be significantly enhanced if the research team will be enlarged with doctoral students, coordinated as a result of the habilitation thesis.

The full abstract at:

http://www.upt.ro/img/files/2014-2015/doctorat/abilitare/slavici/Teza_abilitare_Titus_Slavici.pdf

Habilitation Commission

Prof.univ.dr.ing. Anca Alexandra PURCĂREA
Universitatea Politehnică din București;
Prof.univ.dr.ing. Marian GHEORGHE
Universitatea Politehnică din București;
Prof.univ.dr.ing. Moise ACHIM - Universitatea
„1 Decembrie 1918” din Alba-Iulia;
Prof.univ. dr.ing. Petru BERCE
Universitatea Tehnică din Cluj-Napoca;
Prof.univ. dr.ing. Cătălin FETEĂU
Universitatea „Dunărea de Jos” din Galați.

OPTIMAL DESIGN AND CONTROL OF ELECTRICAL MACHINES FOR MORE EFFICIENT ENERGY CONVERSION

Author: Lucian Nicolae TUTELEA

Abstract

The habilitation thesis presents personal work and research results between August 1997 after Ph.D. thesis defended and November 2014. The habilitation thesis contains the following chapters: motivation, research directions, scientific and professional achievements, professional and academic development plan and the references chapter.

The motivation chapter briefly presents the research activities linked to the energy conversion, the cooperation with the other universities and the desire to continue the research and academic activities at superior level as a PhD supervisor in Electrical Engineering field.

In the second chapter, the main research directions such as: induction machine design, biaxial excited synchronous generator, permanent magnet machine, reluctance PM assisted motor, linear oscillatory motors, two rotors, single stator axial air-gap permanent magnet machine and complementary research directions such power electronics converters, are presented. For the each direction, only the main results are presented.

The "Scientific and professional achievements" are presenting in more details the activities from the main research direction.

The research direction on the induction machine design is reflected in five paragraphs. The induction machine design for flywheel energy storage project was developed during a post doc stay at Allborg University. A design of outer rotor induction machine software was produced and optimal flux control to reduce the losses at low load.

The research on permanent magnet directions is reflected in the following chapters: optimal design of surface permanent magnet machine, internal permanent magnet machine but also in induction machine and surface permanent magnet machine design for in-wheel mounted drive for electric car. The optimal design software considering analytical models based on magnetic equivalent circuit, validated by finite element was developed for the surface permanent machine in two versions: with fractionary tooth wound windings and for distributed winding.

The two rotors, one stator axial air-gap permanent magnet machine was another major research project in cooperation with Casino University, Italy. The main idea was to boost the hybrid vehicle development by some original contribution on electrical machines topology by combining the requested two machines in a single dual port machine.



The bi-excited generator for automobiles (BEGA) research project has been focused on the efficiency of the automotive generators improvements by new generators topologies. We cooperate in this project with Aalborg University and Grundfos.

The powers electronics and control of the wind turbine generators are complementary subjects in a tight relation with electrical machines and energy conversion.

In the chapter "professional and the academic development plan" two future projects already started are described briefly with a short presentation of the main problems that will be solved. It is also presented the cooperation's strategy with the futures PhD students and a strategy to attracting them through research results at the highest level.

The full abstract at:

http://www.upt.ro/img/files/2014-2015/doctorat/abilitare/tutelea/1_T_abilitare_Tutelea.pdf

Habilitation Commission

Prof.univ.dr.ing. Mihai Octavian POPESCU
Universitatea Politehnica din București;
Prof.univ.dr.ing. Mircea RĂDULESCU
Universitatea Tehnică din Cluj-Napoca;
Prof.univ.dr.ing. Lorand SZABO
Universitatea Tehnică din Cluj-Napoca.

GRAPHITE-BASED COMPOSITE ELECTRODE MATERIALS FOR THE ELECTROANALYSIS

Author: Florica MANEA

Abstract

In this habilitation thesis that represents a sum of more than 25 ISI-ranked papers as principal author and about 7 PhD thesis for which the candidate activated as daily PhD supervisor, Florica MANEA's research activity is briefly presented and structured based on the research themes and chronological evolution.

The first part consisted of the main research activity already performed linked to the published results. Graphite-based composite electrode materials for the electroanalysis, graphite-epoxy composite microelectrode for biosensing, nanostructured-carbon composite electrode materials for electroanalysis and advanced water treatment using electrochemical, photocatalysis-assisted electrochemical and photoelectrocatalytical processes are the main research themes initiated and developed by the candidate after PhD completing and defending.

The results presented in Graphite-based composite electrode materials for the electroanalysis were obtained mainly in the framework of a CEEEX-ET Romanian excellence research project developed and managed in the period of 2005-2007 by the candidate.

Graphite-epoxy composite microelectrode for biosensing represents an approach that considered the properties of the graphite composite macroelectrode and its miniaturization possibility to be able to use it for in-vivo detection of dopamine (DA) and molecular O₂ at the brain level. This study was developed by cooperation with the University of Sassari, Italy with the main idea to find an easy method to construct a graphite-composite microsensor suitable for the implantation in brain.

In the framework of Romanian exploratory research project PNII Ideas 165/2011, our research group has been investigated the synthesis, characterization and application of the unmodified/modified nanostructured carbon composite electrode in the electroanalysis, in order to improve the electro-detection performance. Carbon nanotubes (CNTs) and carbon nanofibers (CNFs) as nanostructured carbon were used also as substrate for the electrodeposition of metallic nanoparticles, Ag and Cu.



In Advanced water treatment using electrochemical, photocatalysis-assisted electrochemical and photoelectrocatalytical processes, three types of advanced oxidation processes (AOPs) have been developed in our group based on the electrochemical oxidation, i.e., photocatalytically-assisted electrooxidation and photoelectrocatalysis. This study represents a part of research activity of a Romanian collaborative project WATUSER 60/2012.

The second part consisted of the future research activity that will be focused on:

- i. new and advanced electrode materials characterized by the enhanced properties in relation with sensing applications;
- ii. new and advanced electrode materials characterized by the enhanced properties for energy storage;
- iii. developing new electrochemically-based advanced processes for water/wastewater treatment technology at pilot-scale;

The full abstract at:

http://www.tuiasi.ro/uploads/files/Abstarct_F_Manea.pdf

Habilitation Commission

Prof.univ.dr.ing. Alexandra Raluca IORDAN
Universitatea „Alexandru Ioan Cuza” din Iași

Prof.univ.dr.ing. Gabriel Octavian LAZĂR
Universitatea „Vasile Alecsandri” din Bacău

Prof.univ.dr.ing. Carmen TEODOSIU
Universitatea Tehnică „Gheorghe Asachi” din Iași

PhD Thesis

EVOLUTION OF PhD THESIS DEFENDED IN UPT 2012-2015

PhD students of UPT are those with a high degree of personal motivation that stems from their natural curiosity and love of intellectual pursuits. It is expected that after they obtain their degree they will metamorphose into scholars for whom also the temptation of researching new and exciting subjects is irresistible, or at least preferable to all other choices.

Doctoral programs usually encompass intensive training in research methods, including interviewing, surveys, questionnaires, clinical trials and laboratory experiments; later, those skills are put into practice when the doctoral candidate conducts fieldwork for his dissertation. Skills gained in qualitative and quantitative research methodology and statistical analysis are transferable to non-academic research environments, particularly for industrial research. In addition, employers outside of academia seek individuals with sound research skills to carry out projects at think tanks and research institutes in both the private and government sectors.

In this chapter we present a list of the PhD Thesis defended in Politehnica University of Timisoara during 2015.

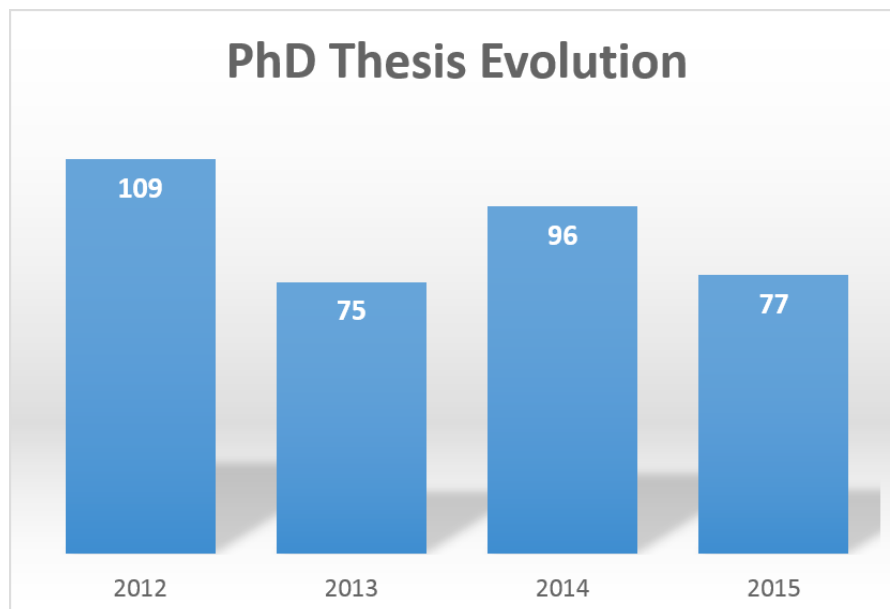

Automation

Corina Anca MNERIE
Supervisor prof. Ș. PREITL

Soluții pentru conducerea unor procese optomecatronice cu aplicații în domeniul biomedical
(Control solutions for optomechatronic devices used in biomedical applications)

Computers and Information Technology

Mariana Carmen PERIANU HOLOTESCU
Supervisor prof. V.I. CREȚU

Noi tehnologii educaționale. Concepția și dezvoltarea unei platforme de microblogging pentru învățare formală și informală
(Emerging Technologies in Education. Conceiving and Building a Microblogging Platform for Formal and Informal Learning)

Cristian COȘARIU
Supervisor prof. M. VLĂDUȚIU

Controlul adaptiv al traficului utilizând optimizarea bio-inspirată
(Adaptive traffic control using bio-inspired optimization)

Alexandru IVANOVICI
Supervisor prof. M. VLĂDUȚIU

Proiectarea rețelelor de senzori cu latență redusă și toleranță la defecte bazat pe Știința Rețelelor
(Designing low latency, fault tolerant Sensor Networks based on Network Science)

Andreea BOZESAN
Supervisor prof. M. VLĂDUȚIU

Contribuții în domeniul securității informației. Mecanisme de detecție a erorilor
(Contributions in the field of information security. Error-Detection Mechanisms)

Călin-Adrian POPA
Supervisor prof. Ș. HOLBAN

Algoritmi de învățare pentru rețele neuronale
(Learning algorithms for clifford neural networks)

Cristina-Sorina CERTEJAN
Supervisor prof. V.I. CREȚU

Eficiențizarea consumului de energie în sisteme timp-real
(Improving energy efficiency in real-time systems)

Valentin STĂNGACIU
Supervisor prof. V.I. CREȚU

Comunicare wireless timp real pentru rețele de senzori
(Real-time wireless communications for sensor networks)

Ionuț Adrian CHIRIAC
Supervisor prof. L. STOICU-TIVADAR

Contribuții privind interacțiunea cu sistemele informatice de educație medicală pentru persoanele cu handicap auditiv
(Contributions to information systems interaction in medical education for hearing impaired persons)

Systems Engineering

Radu-Codruț DAVID
Supervisor prof. R.E. PRECUP

Contribuții la modelarea și optimizarea sistemelor de conducere fuzzy
(Contributions to modeling and optimization of fuzzy control systems)

Alexandru CODREAN
Supervisor prof. T.L.DRAGOMIR

Analiza sistemică a procesului de reglare cardiovascular
(Systems analysis of cardiovascular regulation)

Radu BORACI
Supervisor prof. O. PROȘTEAN

Contribuții la dezvoltarea unor structuri de sisteme pentru conversia energiei eoliene în energie electrică
(Contribution to the development of structures for wind energy conversion systems)

Flaviu FEIER
Supervisor prof. I. SILEA

Structuri, metode și aplicații utilizate la analiza semnalului din plânsul nou-născuților în vederea asistării deciziei medicale
(Structures, methods and applications utilized at the analysis of the signal from the newborn cry in order to assist the medical decision)

Electrical Engineering

Emil GURAN
Supervisor prof. N. MUNTEAN

Convertoare de putere pentru aplicații cu energie regenerabilă
(Power converters for renewable energy applications)

Power Engineering

Antheia DEACU
Supervisor prof. Ș. KILYENI

Proгноza consumului de energie electrică utilizând rețele neuronale artificiale
(Artificial neural networks based load forecasting)

Violeta Eugenia CHIȘ
Supervisor prof. Ș. KILYENI

Tehnici de inteligență artificială utilizate în studiile de prognoză din domeniul ingineriei energetice
(Artificial neural networks in power engineering forecasting studies)

Marcela LIȚCANU
Supervisor prof. P. ANDEA

Optimizarea managementului centralei electrice virtuale OptiMaCEV
(Optimization virtual power plant management OptiMaCEV)

Electronic Engineering and Telecommunications

Gheorghe Daniel POPA
Supervisor prof. M. OTEȘTEANU

Contribuții la recunoașterea gesturilor dinamice efectuate cu mâna pentru interfețe om mașină
(Dynamic hand gestures recognition for human computer interaction)

Ioana-Monica POP
Supervisor prof. V. POPESCU

O nouă clasă de convertoare DC-DC multifazate cu randament ridicat
(A New Class of High Efficiency Multiphase DC-DC Converters)

Silviu VERT
Supervisor prof. R. VASIU

Integrarea datelor deschise interconectate în aplicații mobile de realitate augmentată
(Integrating linked open data in mobile augmented reality applications)

Roland SZABO
Supervisor prof. A. GONTEAN

Contribuții la dezvoltarea metodelor și algoritmilor pentru calculul poziției brațelor robotice în spațiu folosind recunoaștere de culori. Implementare în FPGA
(Contributions for developing methods and algorithms for computing the position of robotic arms in space using color recognition. Implementation in FPGA)

Civil Engineering

Vergina POPESCU
Supervisor prof. A. RETEZAN

Considerații privind managementul apelor meteorice din centrele populate
(Considerations concerning the management of meteoric water from population centres)

Carla TODUȚ
Supervisor prof. V. STOIAN

Reabilitarea seismică a panourilor prefabricate de perete din beton armat cu ajutorul materialelor compozite
(Seismic strengthening of precast RC wall panels using FRP composites)

Simon-Alexandru PESCARI
Supervisor prof. V. STOIAN

Studii și cercetări privind performanțele energetice ale clădirilor prin prisma sustenabilității
(Studies and researches on energy performance of the buildings based on sustainability)

Mirela Adriana IOAN (căs. CHESOAN)
Supervisor prof. D. DUBINĂ

Performanța seismică a structurilor în cadre duale contravântuite excentric cu bare disipative demontabile și capacitate de re-centrare
(Seismic performance of recentering dual eccentrically braced frames with removable links)

Otilia – Alexandra TUDORAN
Supervisor prof. D. GRECEA

Sisteme modulare integrate pentru situații de urgență
(Integrated modular systems for emergency situations)

Ștefan PAVEL
Supervisor prof. I. BORZA

Contribuții la modernizarea instalațiilor electrice aferente unităților medicale dentare
(Contributions to the modernization of electrical installations for medical dental units)

Horia Florin DAȘCĂU
Supervisor prof. Ghe. BĂNCILĂ
Supervisor prof. Aleksandar SEDMAK

Studii referitoare la efectul sudării cu element activ rotitor asupra proprietăților mecanice și a dezvoltării microstructurii la sudarea unilaterală a aliajului de aluminiu 5083
(Studies related to the effect of friction stir welding on the mechanical properties and microstructure development in single side welding on aluminium alloy)

Marius Lucian BOTOS
Supervisor prof. Ghe. POPA

Contribuții la studiul comportării în exploatare a barajelor cu acumulări nepermanente în varianta transformării în acumulări permanente
(Personal contributions to the study of behavior for the dams operated with non-permanent reservoirs in the variant of transformation into permanent storage solution)

Bogdan DEMETRESCU
Supervisor prof. V.A. STOIAN

Conservarea preventivă a structurilor la clădiri istorice din zone seismice
(Preventive conservation for historic structures in the seismic areas)

Miodrag POPOV
Supervisor prof. D. GRECEA

Reabilitarea integrată a locuințelor colective din panouri mari prefabricate. Soluții structural
(Integrated retrofitting of large prefabricated panel collective dwellings structural solutions)

Anca-Maria MOSCOVICI
Supervisor prof. I. COSTESCU

Contribuții la monitorizarea poluării fonice în construcții și gestionarea datelor preliminare într-un Sistem Informatic Geografic
(Contribution to monitoring noise pollution of construction and preliminary data management in a Geographic Information System)

Industrial Engineering

Mircea Paul SĂMĂNȚĂ
Supervisor prof. M. JĂDĂNEANȚ

Reabilitări termice în contextul dezvoltării durabile a clădirilor de locuit colective. Studiu de caz
(Sustainable thermal rehabilitation of collective dwellings. Case study)

Andrei ADAM
Supervisor prof. T. ICLANZAN

Contribuții privind îmbunătățirea calității pieselor miniaturale sau cu pereți subțiri obținute prin injecție activată ultrasonică
(Contributions for improving the quality of miniature or thin-walled parts made by ultrasonic activated injection)

Mechanical Engineering

Felicia STREIAN
Supervisor prof. I. MANIU
Supervisor prof. A.C. PODARIU

Evaluarea bioposturală a unor parametri biomecanici și aplicații clinice în chirurgia orală și maxilo-facială
(Biopostural assessment of biomechanical parameters and clinical applications in oral and maxillofacial surgery)

Mircea KREPELKA
Supervisor prof. L. MARȘAVINA

Studiu prospectiv privind parametrii geometrici ai protezelor destinate articulației coxofemorale
(Prospective study on geometrical parameters of hip prostheses)

Ionel Aurel DRĂGHICI
Supervisor prof. L.E. ANTON

Analiza câmpului hidrodinamic la intrarea în rotorul pompelor centrifuge de acumulare, la turație variabilă
(Analysis at variable speed of the hidrodinamic field at the storage pumps impeller inlet)

Tudor VOICONI
Supervisor prof. L. MARȘAVINA

Caracterizarea mecanică a spumelor metalice și a structurilor care conțin spume metalice
(Mechanical characterization of metallic foams and structures that contain metallic foams)

Sergiu-Valentin GALAȚANU
Supervisor prof. N. FAUR

Cercetări asupra concentratorilor de tensiune la recipientele sub presiune
(Research regarding stress concentrators of pressure vessels)

Alexandru PERESCU
Supervisor prof. L. BERETEU

Modelarea și simularea comportării unor materiale reologice cu aplicații la amortizorul magnetoreologic
(Modeling and simulation of rheological materials behaviour with applications to magnetorheological damper)

Tony STĂNESCU
Supervisor prof. V. DOLGA

Contribuții la analiza teoretică și experimentală privind integrarea hardware în structura unui robot mobil
(Contributions to the theoretical and experimental analysis regarding hardware integration into the structure of a mobile robot)

Viorica CEBRUCEAN
Supervisor prof. I. IONEL

Studiul procesului de absorbție a CO₂ din gazele de ardere
(The absorption process of CO₂ from flue gases)

Mihail Reinhold WACHTER
Supervisor prof. I. IONEL

Cercetări teoretice și experimentale privind metode de valorificare energetică a deșeurilor menajere
(Theoretical and experimental research on methods of energy recovery from municipal solid wasters)

Ulrich Wilhelm ROST
Supervisor prof. V.A. ȘERBAN
Supervisor prof. Prof. W. BRANDL

Dezvoltarea și caracterizarea unor electrozi-membrane pe bază de nanofibre de carbon pentru aplicații în pilele de combustie
(Development and characterisation of carbon nano fibre based membrane electrode assemblies for PEM fuel cells)

Cosmin-Marian IGHİȘAN
Supervisor prof. R. SUSAN-RESIGA

Hidrodinamica nestaționară a tubului de aspirație al turbinelor hidraulice
(Unsteady hydrodynamics of the hydraulic turbines draft tube)

Corina ȘOȘDEAN
Supervisor prof. L. MARȘAVINA
Supervisor prof. G. DE SCHUTTER

Experimental and numerical investigations of the influence of cracks on mass diffusion in mortar and concrete

Marius COCARD
Supervisor prof. L. MARȘAVINA

Integritatea structurală a componentelor din materiale termoplastice îmbinate prin sudare
(Structural Integrity of Thermoplastic Material Components Joined by Welding)

Materials Engineering

Liviu Viorel PASCU
Supervisor prof. T. HEPUȚ

Cercetări privind îmbunătățirea calității saboților de frână destinați materialului rulant
(Researches on improving the quality of brake shoes meant for use with the rolling stock)

Carsten STRÜBBE
Supervisor prof. V.A. ȘERBAN
Supervisor prof. W. BRANDL

Influența microstructurii aliajelor autofluxante de tip NiCrBSi asupra comportamentului la carburare distructivă
(Influence of microstructure on the metal dusting behaviour of self-fluxing NiCrBSi alloys)

Nicoleta BULARDA
Supervisor prof. T. HEPUȚ

Aliaje metalice utilizate pentru fabricarea jantelor destinate autovehiculelor rutiere
(Metal alloys used to produce wheel rims for road vehicles)

Mihail VĂTĂȘESCU
Supervisor prof. T. HEPUȚ

Contribuții privind creșterea nivelului de securitate și sănătate în muncă pe fluxul de procesare la cald a oțelului
(Contributions to increase safety and health at work flow in hot steel processing)

Alina LĂSCUȚONI
Supervisor prof. T. HEPUȚ

Cercetări privind îmbunătățirea calității saboților de frână destinați materialului rulant
(Research on mathematical modeling of the steel thermal regime in the ladle-tundish-crystallizer)

Mihaela VĂTĂȘESCU (PAȘCA)
Supervisor prof. T. HEPUȚ

Contribuții privind implementarea sistemelor de management sănătate și securitate ocupațională în industria siderurgică
(Contributions management systems, occupational health and safety in the steel industry)

Elena Simona CUTEAN
Supervisor prof. I. MITELEA
Supervisor prof. V.A. ȘERBAN

Procese inovative de depunere a titanului pe suprafața pieselor din oțel
(Innovative processes for titanium deposition on the surface of steel components)

Mihaela Luminița KISS
Supervisor prof. I. GROZESCU

Obținerea de oxizi ai fierului cu proprietăți fizice avansate
(Obtaining iron oxides with advanced physical properties)

Sorina Gabriela ȘERBAN
Supervisor prof. T. HEPUȚ

Cercetări privind valorificarea deșeurilor cu conținut de fier și elemente pentru aliere a oțelului
(Research on waste recovery containing iron and steel alloying elements)

Dacian Ioan TOȘA
Supervisor prof. V.A. ȘERBAN

Materiale metalice amorfe masive duale pe bază de zirconiu și fier cu proprietăți magnetice moi
(Dual phase bulk metallic glasses based on zirconium and iron with good soft magnetic properties)

Engineering and Management

Hanna-Kinga SCHRAMKO-FÖLDVÁRY
Supervisor prof. A. DRAGHICI

Cercetări comparative privind managementul cunoașterii în educația universitară inginerască din România
(Comparative researches on knowledge management in Romanian engineering higher education)

Sorin-Ioan MAISTOR
Supervisor prof. M. MOCAN

Cercetări privind modificările din lanțurile logistice la variațiile de cerere în industria producătoare de componente auto
(Researches regarding the changes in supply chain at demand variations in the automotive industry)

Șerban MICLEA
Supervisor prof. M. IZVERCIAN

Cercetări privind activitățile de marketing la nivelul întreprinderilor mici și mijlocii
(Research regarding marketing activities in small and medium enterprises)

Anca-Diana POPESCU
Supervisor prof. A. DRAGHICI

Aspecte ale managementului diversității în managementul grupurilor
(Aspects of diversity management in groups management)

Ioana-Luminița HARPAN
(căs. POPA)
Supervisor prof. A. DRAGHICI

Dezvoltarea capitalului uman - un posibil model
(Human capital development - a possible model)

Adrian Nicolae DIACONU
Supervisor prof. C.D. DUMITRESCU

Îmbunătățirea calității activităților în administrația publică prin pârghii specifice managementului resurselor umane
(Improving the quality of public administration activities by the human resources management through specific levers)

Șerban POPA
Supervisor prof. G. PROȘTEAN

Eficientizarea managementului timpului și resurselor financiare ale unei persoane fizice și/sau juridice prin dezvoltarea unui suport informatic specific
(Time management and financial resources efficiency of an individual or legal entity through the development of a specific informatic support)

Cristian Ilie OLARIU
Supervisor prof. A. DRAGHICI

Managementul proceselor de afaceri - provocări și performanțe actuale
(Business process management - actual challenges and performances)

Luminița-Maria GOGAN
Supervisor prof. A. DRAGHICI

Capitalul intelectual și impactul său asupra performanței organizaționale
(The intellectual capital and its impact on organizational performance)

Viorica BOTEZ
Supervisor prof. A. DRAGHICI

Impactul politicii de motivare asupra satisfacției și performanței resursei umane în organizații
(The impact of motivation policy over human resource satisfaction and performance in organization)

Zoltan-Bela FARKAS
Supervisor prof. A. DRAGHICI

Impactul managementului calității asupra dezvoltării competențelor tehnice în vederea compatibilizării cu spațiul european și corelarea cu cerințele pieței
(Quality management impact on technical competencies development for their compatibility with the european area and their correlation with the market requirements)

Attila TURI
Supervisor prof. M. MOCAN

Analiza performanțelor în industria automotivă
(Performance analysis in the automotive industry)

Chemical Engineering

Anamaria TODEA
Supervisor prof. F. PETER

Sinteza enzimatică și caracterizarea unor noi biomateriale poliesterice
(Enzymatic synthesis and characterization of novel polyester biomaterials)

Raluca CREȚU
Supervisor prof. N. VASZILCSIN

Intensificarea reacției catodice de degajare a hidrogenului prin cataliză cu vectori de protoni
(Enhancement of cathodic hydrogen evolution reaction by proton carriers)

Dorica-Magdalena ARDELEAN
Supervisor prof. R. PODE

Detecția compușilor farmaceutici și a anionilor din apă utilizând electrozi pe bază de carbon
(Detection of pharmaceuticals and anions in water using carbon-based electrodes)

Simona-Luminița SORESCU
Supervisor prof. M. ȘTEFĂNESCU

Formarea unor combinații de tip carboxilat de Fe(III) și Ni(II) în geluri hibride de silice. Obținerea nanocompozitelor Fe₂O₃/SiO₂ și NiO/SiO₂
(Formation of some Fe(III) and Ni(II) carboxylates in hybrid silica gels. Obtaining of Fe₂O₃/SiO₂ and NiO/SiO₂ nanocomposites)

Architecture

Vlad Gabriel GURZA
Supervisor prof. T.O. GHEORGIU

Securitatea urbană
(Urban security)

Gabriela PAȘCU
Supervisor prof. T.O. GHEORGIU
Supervisor prof. J. BAYON

The Industrial Mining Heritage - Factor of territorial development

Cristina Maria POVIAN
Supervisor prof. C. DUMITRESCU

Strategii arhitecturale pentru copiii aflați în situații de risc
(Architectural strategies for children in need)

Marius Stelian GĂMAN
Supervisor prof. S.M. BICA

Metodologie de cuantificare a sustenabilității mediului construit și strategii de intervenție
(Quantification and intervention strategies for urban sustainability)

Scientific Conferences

Scientific Conferences held in 2015



9th INTERNATIONAL CONFERENCE ON PROFESSIONAL COMMUNICATION AND TRANSLATION STUDIES

26-27 March 2015, Timisoara

Organizer: Politehnica University of Timisoara, Department of Communication and Translation Studies

<http://www.cls.upt.ro/manifestari-stiintifice/conferinte>

- The 9th edition of the conference focused on Language and Communication in the digital era. We aimed to develop the exchange of ideas on the impact of new technologies on communication, to highlight the evolution of humanities and social sciences in conjunction with technological innovation, or to see how the language industry has adapted itself to the challenges of today's digitized world.
- The conference tracks included Communication and public relations, Linguistics, Translation studies, and Foreign language teaching.
- Selected papers will be published in Professional Communication and Translation Studies, the volume of conference proceedings, indexed in Ebsco - Communication & Mass Media Complete™ (CMMC), CEEOL, Index Copernicus, Fabula, and in the Scientific Bulletin of the "Politehnica" University of Timișoara, Transactions on Modern Languages, indexed in Ebsco and CEEOL.
- PCTS10 will be organized in 2017.

10th Jubilee IEEE International Symposium on Applied Computational Intelligence and Informatics

SACI 2015

21-23 May 2015, Timisoara, Romania

Organizer: Politehnica University of Timisoara, faculty of Automation and Computers and Óbuda University, Budapest, Hungary

<http://conf.uni-obuda.hu/saci2015/index.html>

SACI 2015

- SACI 2015 conference focuses on Computational Intelligence, Intelligent Mechatronics, Systems Engineering, Artificial Intelligence, Intelligent Manufacturing Systems, Intelligent Control, Genetic, Neural and Fuzzy Algorithms, Expert Systems, Advanced Informatics Applications, Information Technology in Biomedicine
- The aim of the conference is to provide platform for scientist, teachers, researchers, and students as well as to publish their papers, and discuss the results.
- SACI conference appears on the AUSTRALIAN RESEARCH COUNCIL list, in class C.
- The conference appears on the IEEE Conference Search.
- Conference proceedings that meet IEEE quality review standards may be eligible for inclusion in the IEEE Xplore Digital Library.



13th International Symposium "Acoustics and Vibration of Mechanical Structures"-AVMS-2015

28-239May 2015, Timisoara, Romania

Organizer: Politehnica University Timișoara, Romanian Academy-Branch of Timisoara, University of Niš-Noise and Vibration Laboratory, and Romanian Acoustical Society

<http://www.mec.upt.ro/meca/avms/main.php>

- AVMS Symposium 2015 conference focuses on Noise and vibration control, noise and vibration generation and propagation, effects of noise and vibration, condition monitoring and vibration testing, nonlinear acoustics and vibration, analytical, numerical and experimental techniques for noise and vibration, modeling, prediction and simulations of noise and vibration, environmental and occupational noise and vibration, noise and vibration attenuators, regulations requirements and quality assurance systems related to acoustics/vibration, biomechanics and bioacoustics
- The Proceedings of AVMS-2015 was published by „Applied Mechanics and Materials”, indexed by many international databases, including SCOPUS.
- The Symposium was intended to serve as a platform for researchers, engineers, academicians, as well as professionals from industry to present and discuss their latest research results in the field of noise and vibration.
- The symposium is organized every two years.



INTERNATIONAL CONFERENCE ON APPLIED SCIENCE - ICAS2015

3-5 June 2015, Wuhan, China

Organizer: Military Economics Academy of Wuhan in partnership with Politehnica University of Timisoara

<http://www.fih.upt.ro/v3/ICAS2015/index.htm>

Topics of the conference covers a comprehensive spectrum of issues from:

1. Economical Sciences and Defense: Management Sciences, Business Management, Financial Management, Logistic, Human Resources, Crisis Management, Risk Management, Quality Control, Analysis and Prediction, Government Expenditure, Computational Methods in Economics, Military Sciences, National Security, and others...
2. Fundamental Sciences and Engineering: Interdisciplinary applications of physics, Numerical approximation and analysis, Computational Methods in Engineering, Metallic Materials, Composite Materials, Metal Alloys, Metallurgy, Heat Transfer, Mechanical Engineering, Mechatronics, Reliability, Electrical Engineering, Circuits and Systems, Signal Processing, Software Engineering, Data Bases, Modeling and Simulation, and others

Publication of papers

- Proceedings of ICAS2013: IOP Conference Series: Materials Science and Engineering, vol. 57 (2014).
- Proceedings of ICAS2014: IOP Conference Series: Materials Science and Engineering, vol. 85 (2015).
- Acta Technica Corviniensis
- Review of the Air Force Academy

It's the possibility to publish Proceedings of ICAS2015 in a forthcoming volume of the prestigious IOP Conference Series - Materials Science and Engineering, indexed by Thomson Reuters - Web of Sciences (Conference Proceedings Citation Index) and Scopus.



13th International Symposium in Management - SIM 2015

Management During and After the Economic Crisis

9-10 October 2015, Timisoara, Romania

Organizer: Politehnica University of Timisoara and West University of Timisoara

<http://www.sim2015.org/index.html>

- The conference aims to bring together academics, professionals, and students in order to discuss the challenges that management had to deal with during the economic crisis and with which it has been dealing with ever since.
- Our purpose is to address specific questions, such as the role of management in a rapidly-changing environment, the key management problems that must be addressed and solved using particular methods and techniques, while considering the threats and opportunities that appear in this dynamic period of time.
- Attention focuses on crisis management, management of innovation, business process management, entrepreneurship and innovation, financial management and financial governance, strategic management, organizational development and change management, logistics and supply chain, operations management, quality management, sustainable management, management in third sector organisations and social entrepreneurship, quantitative and qualitative methods in management, global management, responsible leadership.
- Like in the previous edition of SIM, the papers will be published by Elsevier "Procedia - Social and Behavioral Sciences" and sent for indexation in ISI Thomson Reuters. The best papers will be published in ISI-quoted journals based on the selection of a scientific advisory committee.

AMS '15

The 6th International Conference on Advanced Materials and Structures - AMS'15

16 - 17 October 2015, Timișoara

Organizer: Politehnica University of Timisoara and Politehnica Foundation

<http://eng.upt.ro/imf/AMS%202015/Home.html#>

Main Topics was:

1. Amorphous and nano-structured materials,
 2. Composites and cellular materials,
 3. Advanced metallic and ceramic materials,
 4. Biomaterials,
 5. Modern fabrication and recycling technologies,
 6. Computational techniques for advanced and engineering materials.
- Proceedings of AMS'15 will be published as separate edition in "Solid State Phenomena"
 - Volume containing the peer-reviewed papers will be available in full text through www.scientific.net platform, which is one of the leading site and largest online databases in Materials Science
 - "Solid State Phenomena" is indexed by Elsevier SCOPUS, ISI (ISTP, CPCI, Web of Science), Ei Compendex (CPX), Cambridge Scientific Abstracts (CSA), Chemical Abstracts (CA), Institution of Electrical Engineers (IEE), Google Scholar, etc.

ICMA 2015

THE 14th INTERNATIONAL CONFERENCE* ON MATHEMATICS AND ITS APPLICATIONS

5-7 November 2015, Timișoara

Organizer: Politehnica University of Timisoara, Department of Mathematics and Romanian Academy - Branch Timisoara

http://www.mat.upt.ro/Informatii_141_ro.html//

The aim of the Conference is to bring together mathematicians, engineers, economists, physicians from all over the world, with research interests in mathematics or in its applications and to attract original papers on the above topics: Mathematical Analysis and Applications, Algebra and Geometry, Computer Algebra Systems in Research, Applied Mathematics in Engineering and Economics, Probability and Statistics, Applications in Health and Clinical Research

In the framework of the conference organizes two workshops:

- WORKSHOP ON MATHEMATICAL METHODS IN QUANTUM INFORMATION THEORY, satellite event organized within the project Random Matrix Techniques in Quantum Information Theory (RMTQIT-List of participants)
- WORKSHOP ON DYNAMICAL SYSTEMS AND THEIR APPLICATIONS, The first twelve editions of this conference were held under the name of "Symposium of Mathematics and its Applications"
- The accepted papers (after an anonymous referee process) will be published as an Extra Volume of the Scientific Bulletin of Politehnica University of Timisoara (ISSN 1224-6069). This journal is indexed in Zentralblatt MATH, Mathematical Reviews and classified as B+ by Romanian CNCIS standards. The process of ISI classification is also started.

Scientific Journals



Transactions on Automatic Control and Computer Science, Volume 60 (74), Issue 1, 2
<http://www.ac.upt.ro/journal/>

The history of this Journal of the Politehnica University of Timisoara is strongly related to its creation under the name Polytechnic School of Timisoara (Ecole Polytechnique de Timisoara). The journal is dedicated to publishing original theoretical and applicative research results and overviews on the current Research status in Automation, Computer Science and Applied Informatics.

Transactions on Automatic Control and Computer Science is indexed by: Index COPERNICUS (Journals Master List), VINITI (All-Russian Institute of Scientific and Technical Information), (CNCSIS B+ journal).



Transactions on Electronics and Communications, Volume 60 (74), Issue 1, 2
<http://www.tc.etc.upt.ro/bulletin/>

- The journal is dedicated to publishing original theoretical and applicative research results and overviews on the current research status in Electronics and Telecommunications.
- The journal is indexed in:
 - Index Copernicus,
 - Electronics Journal Library
 - Directory of Open Access Journals
 - Ulrich's
 - Cabell's



Transactions on Engineering and Management, Volume 1, Issue 1
<http://www.mpt.upt.ro/eng/research/buletin-stiintific.html>

The Scientific Bulletin of the Politehnica University of Timisoara, **Transactions on Engineering and Management** aims to present the latest thinking and scientific research on major topics:

- management;
- engineering economy.



Transactions on Hydrotechnics, Volume 60 (74), Issue 1, 2

<http://www.ct.upt.ro/buletinhidro/index.htm>

- The Scientific Bulletin of the Politehnica University of Timisoara, Transactions on Hydrotechnics is coordinated since 1992 by the Faculty of Hydrotechnical Engineering. Published papers in the journal focus on engineering sciences, civil engineering, theoretical and applied hydraulic, mathematics and numerical modeling, hydrology and water management, hydrotechnical developments and constructions, land improvement (irrigations, drainage, erosion control), engineering and sustainable rural development, water supply and sewerage systems, wastewater treatment, hydraulic structures and technologies.
- The Journal is published entirely in English, with abstracts and keywords, with international exposure.
- The revue is known for experts from home and abroad, is included in the database (Viniti, Russia) and international catalogs (SUWECO, Czech Republic). The Bulletin is broadcast in 26 foreign institutions and foreign publications received in exchange are in number of 19.

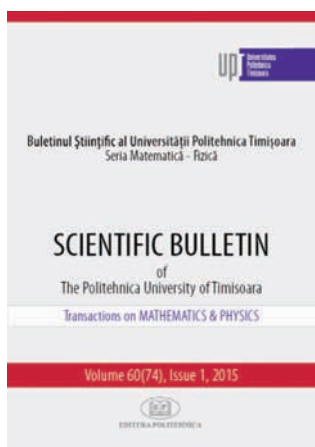

Transactions on Mathematics and Physics, Volume 60, (74) Issue 1, 2

http://www.upt.ro/cercetare/mate_fizica.php

- The journal "Bulletin Scientifique de l'Ecole Polytechnique de Timisoara" was founded in 1923, when the head of the Polytechnical School of Timisoara was mathematicians Victor Valcovici (1885-1970).
- The first two issues appeared in 1925, respectively in 1926. In the first years, the journal has been contained mostly the mathematical articles (the authors being some famous national and foreign mathematicians as well V. Alaci, G. Alexich, M. Ghermănescu, D. Pompeiu, Ch. Brunold, G. Bouligand). This fact confer to actual journal "Transactions on Mathematics and Physics" of the Scientific Bulletin of "Politehnica" University of Timisoara, Romania the justification to realize the continuity of the old "Bulletin Scientifique".
- The **Transactions on Mathematics and Physics** is indexed CNCSIS , B+.

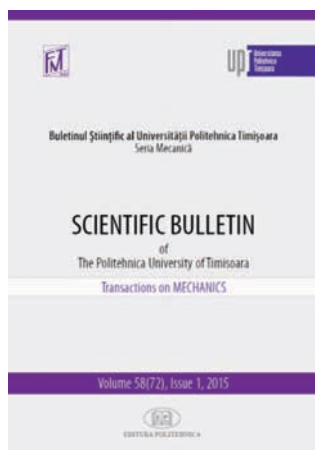

Transactions on Mechanics, Volume 58, (72), Issue 1,2

<http://www.eng.upt.ro/buletin/profile.html>

- The journal is dedicated to publishing original theoretical and applicative research results and overviews on the current research status in Applied Mechanics And Vibration, Resistance Of Materials, Termotechnical, Thermal Machine And Road Vehicles, Fluid Mechanics And Hydraulic Machinery, Machine Elements And Mechanisms, Mechatronics, Manufacturing Technology, Machine Tools, Materials Sciences And Heat Trataments, Equipment And Welding Technology, Industrial Engineering.
- The **Transactions on Mechanics** is indexed CNCSIS , B+.



Transactions on Modern Languages, Volume 14, Issue 1

<http://www.cls.upt.ro/publicatii/buletinul-stiintific>

- The Transactions on Modern languages, published by the Department of Communication and Foreign Languages, has its origin in The Social Science and Humanities Series, started in 1991 under ISSN 1223-1959
- The Transactions of Modern Languages publishes original papers in all areas of theoretical and applied linguistics: Linguistics, Translation and Interpreting Studies, Discourse Analysis, Pragmatics, Rhetoric, Terminology, LSP, Foreign Language Teaching.
- The journal is included in the CEEOL, Fabula and EBSCO data bases.

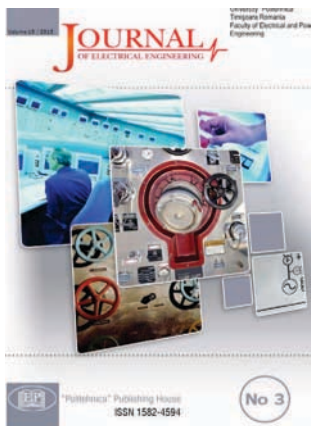

Journal of Electrical Engineering, Volume 15, Edition 1, 2, 3, 4

<http://www.jee.ro/index.php>

- JEE continues the prestigious “Scientific Bulletin” of the Politehnica University of Timisoara, Electrotechnical section, but in electronic form.
- It also aims to become a fully international archival journal.
- Its scope includes all issues of widespread generic interest to engineers who work in the field of electrical engineering.
- The **Journal of Electrical Engineering** is indexed by Scopus, and IEE INSPEC.

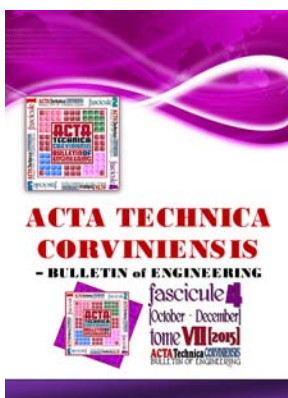

Acta Technica Corviniensis - Bulletin of Engineering, Volume 8, Issue 1. 2. 3. 4

<http://acta.fih.upt.ro/>

- ACTA TECHNICA CORVINIENSIS – Bulletin of Engineering is an international and interdisciplinary journal of the Faculty of Engineering Hunedoara.
- The Journal is focused on engineering sciences and other innovative allied research areas, in all fields of science and technology on the basis of its originality, importance and timeliness.
- ACTA TECHNICA CORVINIENSIS – BULLETIN of ENGINEERING is accredited and ranked in the “B+” CATEGORY Journal by CNCIS, and is indexed by Index Copernicus, Google Scholar, EBSCO Publishing, DOAJ, SCIRUS, Evisa, ProQuest, DRJI, CAS, BASE, ULRICHsweb – Global serials directory, Directory Indexing of International Research Journals, Electronic Journals Library, etc.



Annals of the Faculty Engineering Hunedoara International Journal of Engineering, Volume 15, Issue 1, 2, 3, 4

<http://annals.fih.upt.ro/>

- The Journal is a multi-disciplinary journal which covers all aspects of scientific, engineering and technical disciplines including applications of scientific inventions for engineering, technological and industrial purposes, advances in engineering, technology and science.
- The Journal is accredited and ranked in the B+ category by The National University Research Council's Classification of Romanian Journals, CNCIS, and is indexed by Index Copernicus, Google Scholar, EBSCO Publishing, DOAJ, SCIRUS, EVISA, ProQuest, DRJI, CAS, BASE, etc.



The Nonconventional Technologies Review, Volume 18, Issue 1, 2, 3, 4

<http://www.revtn.ro/archives.htm>

The publication is addressed to all engineers and scientists interested on nonconventional technologies.

The Journals is accredited and ranked in the B+ category by The National University Research Council's Classification of Romanian Journals, CNCIS, and is indexed by Index Copernicus, and ProQuest.

ISI PAPERS

EVOLUTION OF ISI PAPERS UNDER AFFILIATIONS OF UPT 2012-2015

Scientific writing and publication marks the endpoint of research that has been performed, completed, peer reviewed and accepted, and complements teaching and training.

In this chapter we present the publications/papers written by our professors, PhD students, researchers etc. These publications can be: papers published in ISI Journals or papers presented at Conference and indexed in ISI Proceedings.

The number of papers presented in the below figures is greater than the number of papers presented in previous Research Reports. This number varies from year to year because annually it increases the number of publications indexed in the ISI Thompson Reuters database.

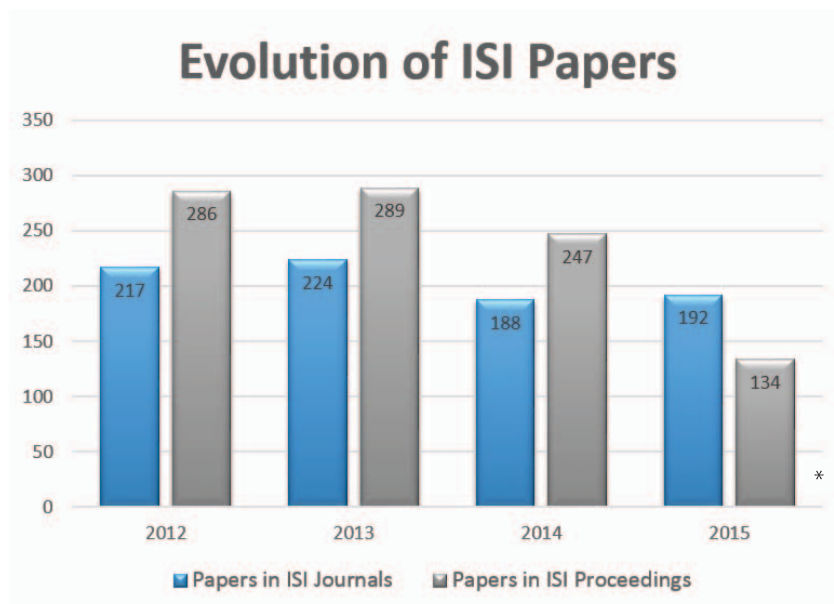
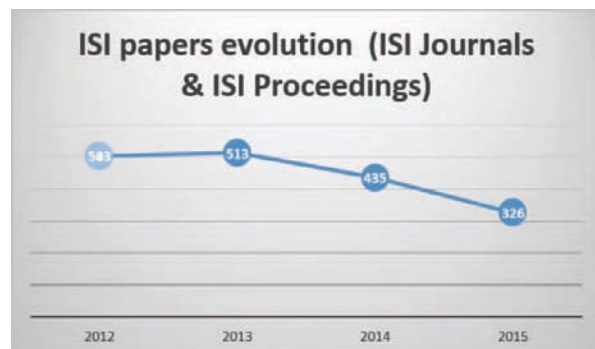

ISI Papers in highlight

A REVIEW OF ENSEMBLE METHODS FOR DE NOVO MOTIF DISCOVERY IN CHIP-SEQ DATA

Andrei LIHU, Ștefan HOLBAN

Briefings in Bioinformatics 2015, Oxford University Press,

doi: 10.1093/bib/bbv022;

Impact factor ISI2014 = 9.617

Short description of the journal

Briefings in Bioinformatics is a highly prestigious international journal published by Oxford University Press. According to Journal Citation Reports 2014, with an impact factor of 9.617, the journal is ranked second in the world in the subject category of "Mathematical & Computational Biology" and third in "Biochemical Research Methods".

Abstract

De novo motif discovery is a difficult computational task. Historically, dedicated algorithms always reported a high percentage of false positives. Their performance did not improve considerably even after they adapted to handle large amounts of chromatin immunoprecipitation sequencing (ChIP-Seq) data. Several studies have advocated aggregating complementary algorithms, combining their predictions to increase the accuracy of the results. This led to the development of ensemble methods. To form a better view on modern ensembles, we review all compound tools designed for ChIP-Seq. After a brief introduction to basic algorithms and early ensembles, we describe the most recent tools. We highlight their limitations and strengths by presenting their architecture, the input options and their output. To provide guidance for next-generation sequencing practitioners, we observe the differences and similarities between them. Last but not least, we identify and recommend several features to be implemented by any novel ensemble algorithm

Key words

Next-generation sequencing, motif discovery, ensemble methods, ChIP-Seq, transcription factors

This work was partially supported by the strategic grant POSDRU/159/1.5/S/137070 (2014) of the Ministry of National Education, Romania, co-financed by the European Social Fund – Investing in People, within the Sectoral Operational Programme Human Resources Development 2007–2013

The authors



- **Andrei LIHU** is a postdoc at the Politehnica University of Timișoara. His research interests are bioinformatics, motif prediction in particular, machine learning and evolutionary computation.



- **Ștefan HOLBAN** received a Ph.D. in Computer Science in 1988 from the University "Politehnica" of Timișoara (UPT), Romania. He is a Professor in the Computer Department of the UPT since 1993 and a member of ACM, IEEE and Romanian Society of Biochemistry and Molecular Biology. His main research topics are system modeling and simulation, knowledge engineering and integrated AI architectures. He is the author of more than 80 papers in refereed journals (J. Polym. Sci., J. Match. Chem. (MATCH), Quant. Struct.-Act. Relat., Eur. J. Med. Chem., J. Chem. Inf. Comput. Sci., Adv. Electr. Comp. Eng. Journal, etc.) and contributions in over 5 books, some of them published by prestigious publishers (Springer, VCH, Wiley, etc.). He has a special interest in the application of modeling and AI techniques to Environmental Decision and Design Support Systems.

GENERAL REVIEW OF SOLAR-POWERED CLOSED SORPTION REFRIGERATION SYSTEMS

Ioan SÂRBU, Călin SEBARCHIEVICI

ENERGY CONVERSION AND MANAGEMENT, Volume 105, Issue 11, pages 403-422, November 2015,

doi: 10.1016/j.enconman.2015.07.084

Impact factor ISI2014=4,380

Short description of the journal

This paper was published in November 2015 by the reputable journal Energy Conversion and Management, ISSN 0196-8904, a high-impact international journal.

This journal published by Elsevier provides a forum for publishing original contributions and comprehensive technical review articles of interdisciplinary and original research on all important energy topics. The topics considered include energy generation, utilization, conversion, storage, transmission, conservation, management and sustainability. These topics typically involve various types of energy such as mechanical, thermal, nuclear, chemical, electromagnetic, magnetic and electric. These energy types cover all known energy resources, including renewable resources (e.g. solar, bio, hydro, wind, geothermal and ocean energy), fossil fuels and nuclear resources.

According to ISI Journal Citation Reports 2014, this journal has an impact factor IF=4,380.

Abstract

This paper provides a detailed review of the solar closed sorption (absorption and adsorption) refrigeration systems, which utilise working pairs (fluids). After an introduction of the basic principles of these systems, the history of development and recent advances in solar sorption refrigeration technologies are reported. The adsorption cooling typically has a lower heat source temperature requirement than the absorption cooling. Based on the coefficient of performance (COP), the absorption systems are preferred over the adsorption systems, and the higher temperature issues can be easily handled with solar adsorption systems. The thermodynamic properties of most common working fluids, as well as the use of ternary mixtures in solar-powered absorption systems, have been reviewed in this study. The paper also refers to new approaches to increase the efficiency and sustainability of the basic adsorption cycles, such as the development of hybrid or thermal energy storage adsorption systems.

This research shows that solar-powered closed sorption refrigeration technologies can be attractive alternatives not only to serve the needs for air-conditioning, refrigeration, ice making, thermal energy storage or hybrid heating and cooling purposes but also to meet the demands for energy conservation and environmental protection.

Key words

Solar energy, Refrigeration, Sorption system, Absorption, Adsorption, Energy efficiency

The authors

- **Ioan SÂRBU** is a professor at the Politehnica University of Timisoara, Department of Civil Engineering and Building Services. He is a European Engineer, as designated by European Federation of National Engineering Associations (Brussels) in 2001. His main research interests are related to refrigeration systems, heat pumps and solar energy conversion. He is also active in the field of thermal comfort and environmental quality, energy efficiency and energy savings, and numerical simulations and optimisations in building services. He published in this field many research articles, one book (Elsevier) and six chapters to books (Springer, InTech, Nova Science Publishers). Additionally, he is a reviewer for some top international journals in this field. He listed in several Who's Who publications (e.g. Who's Who in the World, Who's Who in Science and Engineering, and Who's Who in America) and other biographical dictionaries.
- **Călin SEBARCHIEVICI** is a lecturer at the Politehnica University of Timisoara,, Department of Civil Engineering and Building Services. He received the PhD title in 2013. His research is focused on air conditioning, heat pump and refrigeration systems. He is also active in the field of thermal comfort, energy efficiency, and energy savings. He published in this field many journal papers and is co-author of one book and three book chapters.

EXPERIMENTAL AND NUMERICAL RESEARCH TO ASSESS INDOOR ENVIRONMENT QUALITY AND SCHOOLWORK PERFORMANCE IN UNIVERSITY CLASSROOMS

Ioan SÂRBU, Cristian PACURAR

BUILDING AND ENVIRONMENT, Volume 93 (Part 2), Issue 11, pages 141-154, November 2015,

doi: 10.1016/j.buildenv.2015.06.022

Impact factor ISI2014=3,341

Short description of the journal

This paper was published in November 2015 by the reputable journal *Building and Environment*, ISSN 0360-1323, a high-impact international journal.

This journal published by Elsevier is an international journal that publishes original research papers and review articles related to building science and human interaction with the built environment. The journal invites research articles conveying robust, tested knowledge on thermal, acoustic, visual, air quality building science and human impacts. The journal is focused on new knowledge, rigorously verified with measurement and analysis, related to the environmental performance of buildings in different scales, ranging from cities, communities, buildings, to building systems and assemblies.

- Up to now, this paper is already cited by an article published in the literature, according to the journal web site.

Abstract

The primary aim of this study is to assess thermal comfort based on the predicted mean vote (PMV) and predicted percent dissatisfied (PPD) indices using subjective and experimental measurements in two air conditioned classrooms at a university, where the air-exchange rate is assured by natural ventilation. The indoor environmental conditions were satisfactory, and all situations fit within the comfort limits. The mean value of the PMV index ranges from 0.55 to -0.69 during both seasons, and the mean value of the PPD index ranges from 11.66 to 15.04%. The influence of the air conditioning system and ventilation provided by manually operated windows during the cooling season on thermal comfort parameters and CO₂ concentration are also investigated by in situ measurements. In the absence of a cooling system and the ventilation rates, the air temperature exceeds the maximum comfort limit of 27°C. Additionally, the PMV and PPD indices have the values of 0.87 and 21%, respectively and the CO₂ concentration increases above the admissible limit, reaching a value of 2400 ppm. By manually opening the windows, the CO₂ concentration decreases significantly to 1500 ppm. Thermal comfort is notably improved (PMV=-0.34, PPD=7.4%) when the cooling system is running in the room. The secondary aim of this paper is to develop a prediction model of the academic performance during the cooling season.

Application of this model indicates that the indoor environmental conditions can strongly affect student performance. Finally, a simulation model on the Transient System Simulation (TRNSYS) program of the PMV-PPD indices and heating/cooling energy demand for an amphitheatre with natural ventilation is proposed.

Key words

Higher educational building, Natural ventilation, Thermal comfort, Indoor air quality, Student performance, TRNSYS simulation model

The authors

- **Ioan SÂRBU** is a professor at the Politehnica University of Timișoara, Department of Civil Engineering and Building Services. He is a European Engineer, as designated by European Federation of National Engineering Associations (Brussels) in 2001. His main research interests are related to refrigeration systems, heat pumps and solar energy conversion. He is also active in the field of thermal comfort and environmental quality, energy efficiency and energy savings, and numerical simulations and optimisations in building services. He published in this field many research articles, one book (Elsevier) and six chapters to books (Springer, InTech, Nova Science Publishers). Additionally, he is a reviewer for some top international journals in this field. He listed in several Who's Who publications (e.g. Who's Who in the World, Who's Who in Science and Engineering, and Who's Who in America) and other biographical dictionaries.
- **Cristian PACURAR** is an assistant professor at the Politehnica University of Timișoara, Department of Civil Engineering and Building Services. He received the PhD title in 2013. His research is focused on air conditioning and ambient comfort. He is also active in the field of energy efficiency and environment protection. He published in this field many journal papers and is co-author of one book and one book chapter.

NUMERICAL AND EXPERIMENTAL INVESTIGATION ON SEISMICALLY DAMAGED REINFORCED CONCRETE WALL PANELS RETROFITTED WITH FRP COMPOSITES

Carla TODUT, Daniel DAN, Valeriu STOIAN

COMPOSITE STRUCTURES, Volume 119 (2015), pages 648–665,
<http://dx.doi.org/10.1016/j.compstruct.2014.09.047>

Impact factor ISI2014 = 3,318.

Short description of the journal

This paper was published in September 2014, as electronic version, by the reputable journal Composite Structures, a high-impact international journal.

This journal publishes papers which contribute to knowledge in the use of composite materials in engineering structures. Papers deal with design, research and development studies, experimental investigations, theoretical analysis and fabrication techniques relevant to the application of composites in load-bearing components for assemblies, ranging from individual components such as plates and shells to complete composite structures.

According to ISI Journal Citation Reports 2014, this journal has an impact factor IF=3,318.

Abstract

This paper presents the results of an experimental program on precast reinforced concrete wall panels (PRCWP). These panels were damaged under cyclic lateral loads and thereafter retrofitted or rehabilitated and retested. The experimental program was conceived to analyse the possibilities of using FRP materials for strengthening the PRCWP affected by seismic action. The fibre reinforced polymer (FRP) composites are frequently used in strengthening structural elements because of their superior characteristics and simple technology. The existing literature lacks information concerning reinforced concrete walls (RC) retrofitted by FRP composites compared to other structural members. This paper presents various effective strengthening solutions that can be applied to damaged elements. The retrofitting solutions consist in use of EBR-CFRP strips, combined EBR-CFRP strips with NSM-CFRP plates, textile reinforced mortar (TRM) using glass fibre grid, and TRM using carbon fibre grid. The solutions were proposed with the aim of restoring the wall shear resistance and to provide the confinement effect at the ends. The experimental results indicate that the performance of the elements, repaired and strengthened, were almost equal to or higher than the reference elements in terms of load bearing capacity, stiffness and energy dissipation capacity.

A more ductile behaviour compared to the reference elements was recorded for the rehabilitated and retrofitted elements..

Key words

Seismic performance, Strengthened RC walls, EBR-CFRP, Experimental tests.

- Up to now, this paper is already cited by an article published in the literature, according to the journal web site.

The authors

- **Carla TODUT** is assistant professor at the Politehnica University Timisoara, Civil Engineering Department. She received the PhD title in 2015. The main research topics include the experimental and analytical investigation of precast reinforced concrete wall panels. She published in this field many research articles.
- **Daniel DAN** is full profesor at the Politehnica University Timisoara, Civil Engineering Department. His research interest include the theoretical and experimental investigation of the structural elements for buildings placed in seismic areas. He published in this field many research articles and books.
- **Valeriu STOIAN** is full profesor at the Politehnica University Timisoara, Civil Engineering Department. His research interest include the experimental and analytical investigation of reinforced concrete elements. He published in this field many research articles and books.

AN ANALYTICAL APPROACH TO NON-LINEAR DYNAMICAL MODEL OF A PERMANENT MAGNET SYNCHRONOUS GENERATOR

Nicolae HERISANU, Vasile MARINCA, Gheorghe MADESCU

WIND ENERGY, Volume 18, Issue 9, pages 1657-1670, September 2015

DOI: 10.1002/we.1785

Impact factor ISI2014 = 3,069

Short description of the journal

This paper was published in September 2015 by the reputable journal *Wind Energy*, online ISSN 1099-1824, a high-impact international journal.

According to the on-line version of this journal published by Wiley, *Wind Energy* offers a major forum for the reporting of advances in this rapidly developing technology with the goal of realising the world-wide potential to harness clean energy from land-based and offshore wind. This journal aims to reach all those with an interest in this field from academic research, industrial development through applications, including individual wind turbines and components, wind farms and integration of wind power plants. The journal covers the entire spectrum of scientific and engineering disciplines concerned with the advancement of wind power capture, conversion, integration, and utilization technologies.

According to ISI Journal Citation Reports 2014, this journal has an impact factor $IF=3,069$, so that its ranking 2014 is 5 / 130 in the category "Engineering, Mechanical".

Abstract

This paper proposes an analytical approach to investigate the transitory dynamic regime of a low-power permanent magnet synchronous generator that works in an actual wind power station. The governing non-linear differential equations are solved by means of the optimal homotopy asymptotic method, and explicit analytical solutions are obtained. Four cases are analysed for different moments of inertia and electrical resistances specific to sudden short circuit produced at the generator terminals and sudden change of load. The proposed procedure is highly efficient and controls the convergence of the approximate solutions, ensuring a very fast convergence.

Such an analytical approach allows modeling and simulating turbine generator systems for real-time computations, offline applications or stability problems. Numerical investigations are also performed in order to validate the analytical results.

Key words

Permanent magnet synchronous generator; transitory regime; optimal homotopy asymptotic method

- Up to now, this paper is already cited by four articles published in the literature, according to the journal web site.

The authors

- **Nicolae HERISANU** is full professor at the University Politehnica Timisoara, Faculty of Mechanical Engineering. He received the PhD in 1999 and Habilitation in 2015. The main research topics include the analytical investigation of nonlinear dynamical systems. He published in this field many research articles and two books (Springer 2011 and 2015). He is the head of Acoustics and Vibration Laboratory at University Politehnica Timisoara and reviewer for some top journals in this field.
- **Vasile MARINCA** is full professor at the University Politehnica Timisoara, Faculty of Mechanical Engineering. His research interest includes the analytical investigation of nonlinear dynamical systems and he published in this field many research articles and two books (Springer 2011 and 2015).
- **Gheorghe MADESCU** is scientific researcher at Romanian Academy, branch of Timisoara, Centre for Advanced Technical Research and his research interest lies in the field of electrical machines. He published many journal papers in this field.

Papers in ISI Journals

1. Anastasiadis, A., Mosoarca, M., Gioncu, V. Investigation of the cyclic inelastic capacity of steel beams through the use of the plastic collapse mechanism, *BULLETIN OF EARTHQUAKE ENGINEERING*, Volume: 13, Issue: 5, Pages: 1377-1403, ISSN: 1570761X, eISSN: 15731456, 2015;
2. Andoni, M., Pop, R., Soica, C., Simu, G.M., Ilici, M., Ardelean, S., Onisei, D., Dehelean, C.A. Theoretical Study Regarding the Reactivity of 5 nitrofurancarboxaldehyde Thiosemicarbazone, *REVISTA DE CHIMIE*, Volume: 66, Issue: 5, Pages: 637-639, ISSN: 00347752, 2015;
3. Baci, A., Ardelean, M., Pop, A., Pode, R., Manea, F. Simultaneous Voltammetric/Amperometric Determination of Sulfide and Nitrite in Water at BDD Electrode, *SENSORS*, Volume: 15, Issue: 6, Pages: 14526-14538, ISSN: 14248220, 2015;
4. Baci, A., Pop, A., Bodor, K., Vlaicu, I., Manea, F. Assessment of Electrocoagulation Process for Drinking Water Treatment, *ENVIRONMENTAL ENGINEERING AND MANAGEMENT JOURNAL*, Volume: 14, Issue: 6, Pages: 1347-1354, ISSN: 15829596, eISSN: 18433707, 2015;
5. Ban, O.I., Ancusa, V., Bogdan, V., Tara, I.G., Empirical Social Research to Identify Clusters of Characteristics that Underlie the Online Evaluation of Accommodation Services, *REVISTA DE CERCETARE SI INTERVENTIE SOCIALA*, Volume: 50, Pages: 293-308, ISSN: 15833410, eISSN: 15845397, 2015;
6. Banica, R., Ursu, D., Nyari, T., Svera, P., Vaszilcsin, N. Study of copper diffusion under solvothermal conditions in In₂S₃ layers synthesized by spray pyrolysis, *JOURNAL OF OPTOELECTRONICS AND ADVANCED MATERIALS*, Volume: 17, Issue: 78, Pages: 10121020, ISSN: 14544164, eISSN: 18417132, 2015;
7. Banica, R., Ursu, D., Linul, P., Nyari, T., Vaszilcsin, N. Influence of pH and pressure on the microwaveassisted hydrothermal growth of ZnIn₂S₄, *OPTOELECTRONICS AND ADVANCED MATERIALSRAPID COMMUNICATIONS*, Volume: 9, Issue: 34, Pages: 511-516, ISSN: 18426573, eISSN: 20653824, 2015;
8. Belega, D., Fontanelli, D., Petri, D. Dynamic Phasor and Frequency Measurements by an Improved Taylor Weighted Least Squares Algorithm, *IEEE TRANSACTIONS ON INSTRUMENTATION AND MEASUREMENT*, Volume: 64, Issue: 8, Pages: 2165-2178, ISSN: 00189456, eISSN: 15579662, 2015;
9. Belega, D., Petri, D. Frequency estimation by two or three point interpolated Fourier algorithms based on cosine windows, *SIGNAL PROCESSING*, Volume: 117, Pages: 115-125, ISSN: 01651684, ISSN: 18792677, 2015;
10. Belega, D., Fontanelli, D., Petri, D. Low-Complexity Least-Squares Dynamic Synchrophasor Estimation Based on the Discrete Fourier Transform, *IEEE TRANSACTIONS ON INSTRUMENTATION AND MEASUREMENT*, Volume: 64, Issue: 12, Pages: 3284-3296, 2015;
11. Belegante, L., Cazacu, M.M., Timofte, A., Toanca, F., Vasilescu, J., Rusu, M.I., Ajtai, N., Stefanie, H.I., Vetres, I., Ozunu, A., Gurlui, S. Case Study of the First Volcanic Ash Exercise in Romania Using Remote Sensing Techniques, *ENVIRONMENTAL ENGINEERING AND MANAGEMENT JOURNAL*, Volume: 14, Issue: 11, Pages: 2503-2514, ISSN: 1582-9596, eISSN: 1843-3707, 2015;
12. Bernad, S.I., Bosioc, A.I., Bernad, E.S. Craina, M.L. Helical type coronary bypass graft performance: Experimental investigations, *BIOMEDICAL MATERIALS AND ENGINEERING*, Volume: 26, Pages: 477-486, ISSN: 09592989, eISSN: 18783619, 2015;
13. Binzar, T., Lazureanu, C. On a new chaotic system, *MATHEMATICAL METHODS IN THE APPLIED SCIENCES*, Volume: 38, Issue: 8, Pages: 1631-1641, ISSN: 01704214, eISSN: 10991476, 2015;
14. Birdeanu, M., Sebarchievici, I., Birdeanu, A.V., Taranu, B., Peter, F., Fagadar-Cosma, E. Synthesis, Characterization And Potential Application of Zn₃(Ta_{1-x}Nbx)₂O₈ OXIDES, *DIGEST, JOURNAL OF NANOMATERIALS AND BIOSTRUCTURES*, Volume: 10, Issue 2, pages: 543-555, ISSN: 18423582, 2015;
15. Bistran, D.A., Navon, I.M. An improved algorithm for the shallow water equations model reduction: Dynamic Mode Decomposition vs POD, *INTERNATIONAL JOURNAL FOR NUMERICAL METHODS IN FLUIDS*, Volume: 78, Issue: 9, Pages: 552-580, ISSN: 02712091, eISSN: 10970363, 2015;
16. Blaga, L., Dos Santos, J.F., Bancila, R., Amancio, S.T. Friction Riveting (FricRiveting) as a new joining technique in GFRP lightweight bridge construction, *CONSTRUCTION AND BUILDING MATERIALS*, Volume: 80, Pages: 167-179, ISSN: 09500618, eISSN: 18790526, 2015;

17. Boata, R., Pop, N. Estimation of Global Solar Irradiation by Using Takagi-Sugeno Fuzzy Systems, ROMANIAN JOURNAL OF PHYSICS, Volume: 60, Issue: 34, Pages: 593-602, ISSN: 1221146X, 2015;
18. Boboescu, I.Z., Gherman, V.D., Ilie, M., Lakatos, G., Pap, B., Negrea, A., Kondorosi, E., Maroti, G. Converting organic-rich industrial wastewater into biohydrogen through a novel hybrid dark fermentation–photoheterotrophic approach: Proof of concept, JOURNAL OF BIOTECHNOLOGY, Volume: 208, Pages: S33-S33, Supplement: S, 2015;
19. Bogdan, L., Nes, C.S., Ducan, D., Patrascu, J.M. Experimental Compression Tests on Orthopedic Bone Cement used in Total Hip Replacement, MATERIALE PLASTICE, Volume: 52, Issue: 1, Pages: 125-128, ISSN: 00255289, 2015;
20. Boncalo, O., Amaricai, A., Savin, V., Declercq, D., Ghaffari, F. Check node unit for LDPC decoders based on one hot data representation of messages, ELECTRONICS LETTERS, Volume: 51, Issue: 12, Pages: 907+, ISSN: 00135194, eISSN: 1350911X, 2015;
21. Bota, C., Caruntu, B. Approximate Analytical Solutions of the Fractional Order Brusselator System Using the Polynomial Least Squares Method, ADVANCES IN MATHEMATICAL PHYSICS, Article Number: 450235, ISSN: 16879120, eISSN: 16879139, 2015;
22. Butnariu, M., Negrea, P., Lupa, L., Ciopec, M., Negrea, A., Pentea, M., Sarac, I., Samfira, I. Remediation of Rare Earth Element Pollutants by Sorption Process Using Organic Natural Sorbents, INTERNATIONAL JOURNAL OF ENVIRONMENTAL RESEARCH AND PUBLIC HEALTH, Volume: 12, Issue: 9, Pages: 11278-11287, ISSN: 16604601, 2015;
23. Butnariu, M., Samfira, I., Sarac, I., Negrea, A., Negrea, P. Allelopathic effects of Pteridium aquilinum alcoholic extract on seed germination and seedling growth of Poa pratensis, ALLELOPATHY JOURNAL, Volume: 35, Issue: 2, Pages: 227-236, ISSN: 09714693, eISSN: 09741240, 2015;
24. Cernazanu-Glavan, C., Marcu, M. Anomaly Detection Using Power Signature of Consumer Electrical Devices, ADVANCES IN ELECTRICAL AND COMPUTER ENGINEERING, Volume: 15, Issue: 1, Pages: 89-94, ISSN: 15827445, eISSN: 18447600, 2015;
25. Chicot, D., Ageorges, H., Voda, M., Louis, G., Ben Dhia, M.A., Palacio, C.C., Kossman, S. Hardness of thermal sprayed coatings: Relevance of the scale of measurement, SURFACE & COATINGS TECHNOLOGY, Volume: 268, Pages: 173-179, ISSN: 02578972, 2015;
26. Chiriac, L. If you like music, you can “play” grammar, PROCEEDIA – SOCIAL AND BEHAVIORAL SCIENCES, Pages: 826-833, 2015;
27. Cioabla, A.E., Pop, N., Calinoiu, D.G., Trif-Tordai, G. An experimental approach to the chemical properties and the ash melting behavior in agricultural biomass, JOURNAL OF THERMAL ANALYSIS AND CALORIMETRY, Volume: 121, Issue: 1, Pages: 421-427, ISSN: 13886150, eISSN: 15728943, 2015;
28. Cioca, L.I., Ivascu, L. Characterization of automotive shredder residues before and five years after landfill disposal, Caracterização dos resíduos sólidos de automóveis desmantelados antes e depois da disposição em aterro sanitário, Revista Ambiente & Água, Volume: 10, Issue: 2, Pages: 253-262, ISSN: 1980993X, 2015;
29. Cioca, L.I., Ivascu, L., Rada, E.C., Torretta, V., Ionescu, G. Sustainable Development and Technological Impact on CO2 Reducing Conditions in Romania, SUSTAINABILITY, Volume: 7, Issue: 2, Pages: 1637-1650, ISSN: 20711050, 2015;
30. Ciopec, M., Negrea, A., Pentea, M., Samfira, I., Motoc, M., Butnariu, M. Studies Concerning the Immobilisation and Stabilization of the Mining Landfills, REVISTA DE CHIMIE, Volume: 66, Issue: 5, Pages: 645-653, ISSN: 00347752, 2015;
31. Ciopec, M., Popa, A., Negrea, A., Lupa, L., Negrea, P., Voda, R., Davidescu, C.M., Ilia, G. Comparative characteristics of some polymeric materials impregnated with ionic liquid for the removal of Radionuclides, ENVIRONMENTAL ENGINEERING AND MANAGEMENT JOURNAL, Volume: 14, Issue: 6, Pages: 1287-1294, ISSN: 15829596, eISSN: 18433707, 2015;
32. Codrean, A., Dragomir, T.L. Period dependent averaging of a class of pulse modulated systems. Application to the cardiovascular system, CONTROL ENGINEERING AND APPLIED INFORMATICS, Volume: 17, Issue: 1, Pages: 91-98, ISSN: 14548658, 2015;

33. Craciunescu, C., Ercuta, A. Modulated interaction in double-layer shape memory-based micro-designed actuators, SCIENCE AND TECHNOLOGY OF ADVANCED MATERIALS, Volume: 16, Issue: 6, Article Number: 065003, ISSN: 1468-6996, eISSN: 1878-5514, 2015;
34. Craciunescu, C.M., Miranda, R.M., Silva, R.J.C., Assuncao, E., Fernandes, F.M.B. Surface effects in pulsed laser beam irradiated shape memory alloys, JOURNAL OF OPTOELECTRONICS AND ADVANCED MATERIALS, Volume: 17, Issue: 12, Pages: 45-49, ISSN: 14544164, eISSN: 18417132, 2015;
35. Craciunescu, C.M., Silva, R.J.C., Fernandes, F.M.B. Fracture modes during severe plastic deformation of NiTi shape memory alloys, PHYSICS OF METALS AND METALLOGRAPHY, Volume: 116, Issue: 7, Pages: 698-705, ISSN: 0031918X, eISSN: 15556190, 2015;
36. Creanga, I., Palade, A., Lascu, A., Birdeanu, M., Fagadar Cosma, G., Fagadar Cosma, E. MANGANESE(III) Porphyrin Sensitive To H₂O₂ Detection, DIGEST JOURNAL OF NANOMATERIALS AND BIOSTRUCTURES, Volume: 10, Issue: 1, Pages: 315-321, ISSN: 18423582, 2015;
37. Cretu, C., Cseh, L., Tang, B.J., Sasca, V., Badea, V., Szerb, E.I., Mehl, G., Shova, S., Costisor, O. Mononuclear Cu(II) complexes of novel salicylidene Schiff bases: synthesis and mesogenic properties, LIQUID CRYSTALS, Volume: 42, Issue: 8, Pages: 1139-1147, ISSN: 02678292, eISSN: 13665855, 2015;
38. Curiac, D.I., Pachia, M. Controlled information destruction: the final frontier in preserving information security for every organization, ENTERPRISE INFORMATION SYSTEMS, Volume: 9, Issue: 4, Pages: 384-400, ISSN: 17517575, eISSN: 17517583, 2015;
39. Curiac, D.I., Volosencu, C. Imparting protean behavior to mobile robots accomplishing patrolling tasks in the presence of adversaries, BIOINSPIRATION & BIOMIMETICS, Volume: 10, Issue: 5, 2015;
40. Curiac, D.I., Volosencu, C. Path Planning Algorithm based on Arnold Cat Map for Surveillance UAVs, DEFENCE SCIENCE JOURNAL, Volume: 65, Issue: 6, Pages: 483-488, ISSN: 0011-748X, eISSN: 0976-464X, 2015;
41. Dan, M.L., Vaszilcsin, N., Duteanu, N.M. Electrochemical Behavior of CaBaCo₂O₅ +/-delta in Neutral Aqueous Solution, STUDIA UNIVERSITATIS BABES-BOLYAI CHEMIA, Volume: 60, Issue: 4, Pages: 165-172, ISSN: 1224-7154, 2015;
42. Dascalu, D., Pitulice, L., Ionel, R., Bizerea-Spiridon, O. The usage of a zeolitic composite for quality improvement of copper contaminated mining wastewaters, INTERNATIONAL JOURNAL OF ENVIRONMENTAL SCIENCE AND TECHNOLOGY, Volume: 12, Issue: 7, Pages: 2285-2298, ISSN: 17351472, eISSN: 17352630, 2015;
43. Davidescu, C.M., Dumitru, R., Negrea, A., Lupa, L., Ciopec, M., Negrea, P. Arsenic Removal Through Adsorption on Cobalt Nanoferrite, REVISTA DE CHIMIE, Volume: 66, Issue: 11, Pages: 1742-1746, ISSN: 0034-7752, 2015;
44. Dinu, F., Dubina, D., Marginean, I. Improving the structural robustness of multistory steel frame buildings, STRUCTURE AND INFRASTRUCTURE ENGINEERING, Volume: 11, Issue: 8, Pages: 1028-1041, ISSN: 15732479, eISSN: 17448980, 2015;
45. Dubina, D., Ungureanu, V., Gilia, L. Experimental investigations of cold-formed steel beams of corrugated web and built-up section for flanges, THINWALLED STRUCTURES, Volume: 90, Pages: 159-170, ISSN: 02638231, eISSN: 18793223, 2015;
46. Dulcea, D., Ionel, I., Pascu, L.F. Comparative Study of Pollutant Emissions from the Fossil Fuel Power Plant and Influence Upon Urban Air Quality in Timisoara, REVISTA DE CHIMIE, Volume: 66, Issue: 8, Pages: 1232-1238, ISSN: 00347752, 2015;
47. Dulceau, D., Varga, L.A., Ionel, I. Study Concerning the NO_x Generated by the Urban Traffic, District Heating and Individual Heating Systems from Downtown Timisoara, REVISTA DE CHIMIE, Volume: 66, Issue: 7, Pages: 1042-1045, ISSN: 00347752, 2015;
48. Duma, V.F., Tankam, P., Huang, J.X., Won, J., Rolland, J.P. Optimization of galvanometer scanning for optical coherence tomography, APPLIED OPTICS, Volume: 54, Issue: 17, Pages: 5495-5507, ISSN: 1559128X, eISSN: 21553165, 2015;
49. Dumitrache, F., Morjan, I., Fleaca, C., Badoi, A., Manda, G., Pop, S., Marta, D.S., Humnic, G., Humnic, A., Vekas, L., Daia, C., Marinica, O., Luculescu, C., Niculescu, A.M. Highly magnetic Fe₂O₃ nanoparticles synthesized by laser pyrolysis used for biological and heat transfer applications, APPLIED SURFACE SCIENCE, Volume: 336, Pages: 297-303, ISSN: 01694332, eISSN: 18735584, 2015;

50. Ene, R.D., Marinca, V. Approximate solutions for steady boundary layer MHD viscous flow and radiative heat transfer over an exponentially porous stretching sheet, *APPLIED MATHEMATICS AND COMPUTATION*, Volume: 269, Pages: 389–401, ISSN: 00963003, eISSN: 18735649, 2015;
51. Ene, R.D., Szabo, M. A., Danoiu, S. Viscous flow and heat transfer over a permeable shrinking sheet with partial slip, *REVISTA DE MATERIALE PLASTICE*, Vol. 52 (3), Pages: 408–412, 2015;
52. Epee, M. D., Mezei, J. Zs, Motapon, O., Pop, N., Schneider, I.F. Reactive collisions of very low-energy electrons with H+2 : Rotational transitions and dissociative recombination, *MONTHLY NOTICES OF THE ROYAL ASTRONOMICAL SOCIETY*, IF=5.107, 2015;
53. Florea, C., Malo, M.K.H., Rautiainen, J., Makela, J.T.A., Fick, J.M., Nieminen, M.T., Jurvelin, J.S, Davidescu, A., Korhonen, R.K. Alterations in subchondral bone plate, trabecular bone and articular cartilage properties of rabbit femoral condyles at 4 weeks after anterior cruciate ligament transection, *OSTEOARTHRITIS AND CARTILAGE*, Volume: 23, Issue: 3, Pages: 414–422, ISSN: 10634584, eISSN: 15229653, 2015;
54. Gabor, A., Davidescu, C.M., Negrea, A., Ciopec, M., Lupa, L. Behaviour of Silica and Florisil as Solid Supports in the Removal Process of As(V) from Aqueous Solutions, *JOURNAL OF ANALYTICAL METHODS IN CHEMISTRY*, Article Number: 562780, ISSN: 20908865, eISSN: 20908873, 2015;
55. Gangloff, B., Mazilescu, CA. Is it Desirable or Useful to Believe in a Just World?, *REVISTA DE CERCETARE SI INTERVENTIE SOCIALA*, Volume: 51, Pages: 150–161, ISSN: 1583–3410, eISSN: 1584–5397, 2015;
56. Girbaci, A., Girbaci, C., Petcovici, E., Dodocioiu, A.M. Water Quality Modelling Using Mike 11, *REVISTA DE CHIMIE*, Volume: 66, Issue: 8, Pages: 1206–1211, ISSN: 00347752, 2015;
57. Grigorie, AC., Muntean, C., Stefanescu, M. Obtaining of gamma-Fe2O3 nanoparticles by thermal decomposition of polyethyleneglycol-iron nitrate mixtures, *THERMOCHIMICA ACTA*, Volume: 621, Pages: 61–67, ISSN: 0040–6031, eISSN: 1872–762X, 2015;
58. Gruescu, C.M., Garaiman, A., Lovasz, E.C. Modeling of human spinal column and simulation of spinal deformities, *MECHANIKA*, Issue: 3, Pages: 214–219, ISSN: 13921207, 2015;
59. Gunal, H., Korucu, T., Birkas, M., Ozgoz, E., Halbac-Cotoara-Zamfir, R. Threats to Sustainability of Soil Functions in Central and Southeast Europe, *SUSTAINABILITY*, Volume: 7, Issue: 2, Pages: 2161–2188, ISSN: 20711050, 2015;
60. Hadaruga, DI., Costescu, CI., Corpas, L., Hadaruga, NG., Isengard, HD. Differentiation of rye and wheat flour as well as mixtures by using the kinetics of Karl Fischer water titration, *FOOD CHEMISTRY*, Volume: 195, Pages: 49–55, 2015;
61. Hanke, U., Lovasz, E.C., Zichner, M., Modler, N., Comsa, A., Modler, K.H. Synthesis of PR/RP chain based compliant mechanisms design of applications exploiting fibre reinforced material characteristics, *MECHANICAL SCIENCES*, Volume: 6, Issue: 2, Pages: 155–161, ISSN: 21919151, eISSN: 2191916X, 2015;
62. Heghes, A., Hadaruga, N.G., Fulas, A.V., Bandur, G.N., Hadaruga, D.I., Dehelean, C.A. Capsicum annum extracts/beta-cyclodextrin complexes Thermal analyses Karl Fischer water titration correlations and antioxidant activity, *JOURNAL OF THERMAL ANALYSIS AND CALORIMETRY*, Volume: 120, Issue: 1, Pages: 603–615, ISSN: 13886150, eISSN: 15728943, 2015;
63. Herisanu, N., Marinca, V., Madescu, Gh. An analytical approach to nonlinear dynamical odel of a permanent magnet synchronous generatorm, *WIND ENERGY*, Volume: 18, Issue: 9, Pages: 1657–1670, ISSN: 10954244, eISSN: 10991824, 2015;
64. Hulka, I., Serban, VA., Utu, D., Duteanu, N., Pascu, A., Roata, IC . Corrosion Resistance of Laser Cladded NiCrBSi Composite Coatings, *STUDIA UNIVERSITATIS BABES-BOLYAI CHEMIA*, Volume: 60, Issue: 4, Pages: 173–184, ISSN: 1224-7154, 2015;
65. Iacob, A., Manea, F., Vaszilcsin, N., Picken, S.J.m Schoonman, J. Anodic Determination of Acetylsalicylic Acid at Multiwall Carbon NanotubesEpoxy Composite Electrode, *INTERNATIONAL JOURNAL OF ELECTROCHEMICAL SCIENCE*, Volume: 10, Issue: 7, Pages: 5661–5672, ISSN: 14523981, 2015;

66. Iacob, F., Lute, M. Exact solution to the Schrodinger's equation with pseudo-Gaussian potential, JOURNAL OF MATHEMATICAL PHYSICS, Volume: 56, Issue: 12, Article Number: 121501, ISSN: 0022-2488, eISSN: 1089-7658, 2015;
67. Ianos, R., Lazau, R., Borcanescu, S., Babuta, R. Single step combustion synthesis of YAlO₃ powders, JOURNAL OF MATERIALS SCIENCE, Volume: 50, Issue: 19, Pages: 6382-6387, ISSN: 00222461, eISSN: 15734803, 2015;
68. Ianos, R., Lazau, R., Boruntea, R.C., Solution combustion synthesis of bluish-green BaAl₂O₄: Eu²⁺, Dy³⁺ phosphors, CERAMICS INTERNATIONAL, Volume: 41, Issue: 2, Pages: 3186-3190, ISSN: 02728842, eISSN: 18733956, 2015;
69. Ihos, M., Manea, F., Jitaru, M., Bogatu, C., Pode, R. Diclofenac removal from aqueous solutions by electrooxidation at Boron-Doped Diamond (BDD) electrode, ENVIRONMENTAL ENGINEERING AND MANAGEMENT JOURNAL, Volume: 14, Issue: 6, Pages: 1339-1345, ISSN: 15829596, eISSN: 18433707, 2015;
70. Ion, V.A., Parvulescu, O.C., Dobre, T., Duteanu, N., Nitu, S.G., Modelling of Thermal Desorption of Volatile Organic Compounds from Activated Carbon, REVISTA DE CHIMIE, Volume: 66, Issue: 5, Pages: 703-706, ISSN: 00347752, 2015;
71. Ionel, R., Pitulice, L., Vasiu, G., Mischie, S., Spiridon, O.B. Implementation of a GPRS based remote water quality analysis instrumentation, MEASUREMENT, Volume: 65, Pages: 81-93, ISSN: 02632241, eISSN: 1873412X, 2015;
72. Jivulescu, M.A., Lupa, N., Nechita, I., Reeb, D. Positive reduction from spectra, LINEAR ALGEBRA AND ITS APPLICATIONS, Volume: 469, Pages: 276-304, ISSN: 00243795, eISSN: 18731856, 2015;
73. Jung, H.Y., Stoica, M., Yi, S., Kim, D.H., Eckert, J. Crystallization Kinetics of Fe_{76.5}xC_{6.0}Si_{3.3}B_{5.5}P_{8.7}Cu (x) (x=0, 0.5, and 1 at. pct) Bulk Amorphous Alloy, METALLURGICAL AND MATERIALS TRANSACTIONS A PHYSICAL METALLURGY AND MATERIALS SCIENCE, Volume: 46A, Issue: 6, Pages: 2415-2421, eISSN: 15431940, 2015;
74. Jung, H.Y., Stoica, M., Yi, S.H., Kim, D.H., Eckert, J. Influence of Al on glass forming ability and nanocrystallization behavior of cast-iron based bulk amorphous alloy, JOURNAL OF MATERIALS RESEARCH, Volume: 30, Issue: 6, Pages: 818-824, ISSN: 08842914, eISSN: 20445326, 2015;
75. Jurca, T., Marian, E., Tita, B., Bandur, G., Tita, D., Duteanu, N. Comparative Studies of Pentoxifylline Active Substance and Tablets, REVISTA DE CHIMIE, Volume: 66, Issue: 8, Pages: 1155-1158, ISSN: 00347752, 2015;
76. Kiss, M.L., Chirita, M., Banica, R., Ieta, A., Savii, C., Grozescu, I. Transition from single crystalline FeCO₃ to layered and ordered nanostructured alpha-Fe₂O₃, MATERIALS LETTERS, Volume: 158, Pages: 214-217, ISSN: 0167577X, eISSN: 18734979, 2015;
77. Lăzureanu, C., Bînzar, T. On Some Properties and Symmetries of the 5-Dimensional Lorenz System, Mathematical Problems in Engineering, pages 1-7, 2015;
78. Lăzureanu, C., Bînzar, T. Symmetries of some classes of dynamical systems, JOURNAL OF NONLINEAR MATHEMATICAL PHYSICS, Volume. 22, No. 2, Pages 265-274, 2015;
79. Ledeti, I., Alexa, A., Bercean, V., Vlase, G., Vlase, T., Suta, L.M., Fulfias, A. Synthesis and Degradation of Schiff Bases Containing Heterocyclic Pharmacophore, INTERNATIONAL JOURNAL OF MOLECULAR SCIENCES, Volume: 16, Issue: 1, Pages: 1711-1727, ISSN: 14220067, 2015;
80. Ledeti, I., Bercean, V., Alexa, A., Stoica, C., Suta, L.M., Dehelean, C., Trandafirescu, C., Muntean, D., Licker, M., Fulfias, A. Preparation and Antibacterial Properties of Substituted 1,2,4-Triazoles, JOURNAL OF CHEMISTRY, Article Number: 879343, ISSN: 20909063, eISSN: 20909071, 2015;
81. Ledeti, I., Vlase, G., Vlase, T., Bercean, V., Fulfias, A. Kinetic of solid state degradation of transitional coordinative compounds containing functionalized 1,2,4-triazolic ligand, JOURNAL OF THERMAL ANALYSIS AND CALORIMETRY, Volume: 121, Issue: 3, Pages: 1049-1057, ISSN: 13886150, eISSN: 15728943, 2015;

82. Ledeti, I., Vlase, G., Vlase, T., Ciucanu, I., Olariu, T., Todea, A., Fulfias, A., Suta, L.M. Instrumental Analysis of Potential Lovastatin excipient Interactions in Preformulation Studies, *REVISTA DE CHIMIE*, Volume: 66, Issue: 6, Pages: 879-882, ISSN: 00347752, 2015;
83. Ledeti, I., Vlase, G., Vlase, T., Suta, L.M., Todea, A., Fulfias, A. Selection of solid state excipients for simvastatin dosage forms through thermal and nonthermal techniques, *JOURNAL OF THERMAL ANALYSIS AND CALORIMETRY*, Volume: 121, Issue: 3, Pages 1093-1102, ISSN: 13886150, eISSN: 15728943, 2015;
84. Lemle, LD. On the -Uniqueness of Symmetric Diffusion Operators on Complete Non-Compact Riemannian Manifolds, *JOURNAL OF GEOMETRIC ANALYSIS*, Volume: 25, Issue: 4, Pages: 2375-2385, 2015;
85. Lihu, A., Holban, S. A review of ensemble methods for de novo motif discovery in ChIP-Seq data, *OXFORD JOURNALS, Briefings in Bioinformatics*, Impact Factor: 9.617, 2015;
86. Lihu, A., Holban, S. De novo Motif Prediction using the Fireworks Algorithm, *INTERNATIONAL JOURNAL OF SWARM INTELLIGENCE RESEARCH*, Volume 6, Issue 3, 2015, Pages 24-40, 2015;
87. Linul, E., Marsavina, L. Assesment of Sandwich Beams with Rigid Polyurethane Foam Core Using Failure-Mode Maps, *PROCEEDINGS OF THE ROMANIAN ACADEMY SERIES A-MATHEMATICS PHYSICS TECHNICAL SCIENCES INFORMATION SCIENCE*, Volume: 16, Issue: 4, Pages: 522-530, ISSN: 1454-9069, 2015;
88. Lovasz, E.C., Modler, K.H., Neumann, R., Gruescu, C.M., Perju, D., Ciupe, V., Maniu, I. Novel Design Solutions for Fishing Reel Mechanisms, *CHINESE JOURNAL OF MECHANICAL ENGINEERING*, Volume: 28, Issue: 4, Pages: 726-736, ISSN: 10009345, eISSN: 21928258, 2015;
89. Lupa, L., Negrea, A., Ciopec, M., Negrea, P., Voda, R. Ionic liquids impregnated onto inorganic support used for thallium adsorption from aqueous solutions, *SEPARATION AND PURIFICATION TECHNOLOGY*, Volume: 155, Pages: 75-82, 2015;
90. Ma, K., Tutelea, L., Boldea, I., Ionel, D.M., Blaabjerg, F. Power Electronic Drives, Controls, and Electric Generators for Large Wind Turbines An Overview, *ELECTRIC POWER COMPONENTS AND SYSTEMS*, Volume: 43, Issue: 12, Special Issue: SI, Pages: 1406-1421, ISSN: 15325008, eISSN: 15325016, 2015;
91. Maftai, C.V., Fodor, E., Jones, P.G., Franz, M.H., Davidescu, C.M., Neda, I. Asymmetric calixarene derivatives as potential hosts in chiral recognition processes, *URE AND APPLIED CHEMISTRY*, Volume: 87, Issue: 4, Pages: 415-439, ISSN: 00334545, eISSN: 13653075, 2015;
92. Maranescu, B., Visa, A., Maranescu, V. oVinyl Phosphonate Electrical Properties, *PHOSPHORUS SULFUR AND SILICON AND THE RELATED ELEMENTS*, Volume: 190, Issue: 56, Special Issue: SI, Pages: 902-904, ISSN: 10426507, eISSN: 15635325, 2015;
93. Marian, E., Jurca, T., Tita, B., Sfirloaga, P., Tita, D., Duteanu, N. Comparative Study of Teophylline Active Substance and Commercial Drug Using the Physicochemical Methods, *REVISTA DE CHIMIE*, Volume: 66, Issue: 4, Pages: 477-481, ISSN: 00347752, 2015;
94. Marinca, V., Ene, R.D., Marinca, B. Approximate Analytic Solutions of a Nonlinear Elastic Wave Equations With The Anharmonic Correction, *PROCEEDINGS OF THE ROMANIAN ACADEMY SERIES AMATHEMATICS PHYSICS TECHNICAL SCIENCES INFORMATION SCIENCE*, Volume: 16, Issue: 1, Pages: 80-86, ISSN: 14549069, 2015;
95. Matekovits, L., De Sabata, A. Signal Integrity Applications of an EBG Surface, *ADVANCES IN ELECTRICAL AND COMPUTER ENGINEERING*, Volume: 15, Issue: 2, Pages: 38, ISSN: 15827445, eISSN: 18447600, 2015;
96. Mates, D., Grosu, V., Hlaciuc, E., Bostan, I., Bunget, O., Domil, A., Moraru, M., Artene, A. Biological Assets and the Agricultural Products in the Context of the Implementation of the IAS 41: A Case Study Of The Romanian Agrofood System, *ARCHIVES OF BIOLOGICAL SCIENCES*, Volume: 67, Issue: 2, Pages: 705-714, ISSN: 03544664, eISSN: 18214339, 2015;

97. Mircea, I., Falup, O., Ivan, R., Ionel, I. Reducing GHG Emissions with SRC, *REVISTA DE CHIMIE*, Volume: 66, Issue: 1, Pages: 115-118, ISSN: 00347752, 2015;
98. Mircea, I., Falup, O., Ivan, R., Samoila, I., Ionel, I. Romanian Projections for Certain Atmospheric Pollutants by 2030, as a Result of Implementation the Environmental Legislation, *REVISTA DE CHIMIE*, Volume: 66, Issue: 2, Pages: 247-250, ISSN: 00347752, 2015;
99. Mirel, I., Florescu, C., Girbaci, A., Girbaci, C., Dumitru, P., Dan, S., Popovici, R.A., Ionescu, G.L. Effects of Quantitative Changes on Drinking Water Quality Indicators of Urban Distribution Networks, *MATERIALE PLASTICE*, Volume: 52, Issue: 4, Pages: 504-509, 2015;
100. Mitelea, I., Bordeasu, I., Pelle, M., Craciunescu, C. Ultrasonic cavitation erosion of nodular cast iron with ferrite-pearlite microstructure, *ULTRASONICS SONOCHEMISTRY*, Volume: 23, Pages: 385-390, ISSN: 13504177, eISSN: 18732828, 2015;
101. Mitelea, I., Dimian, E., Bordeasu, I., Craciunescu, C. Cavitation Erosion of Laser Nitrided Ti6Al4V Alloys with the Energy Controlled by the Pulse Duration, *TRIBOLOGY LETTERS*, Volume: 59, Issue: 2, ISSN: 10238883, eISSN: 15732711, 2015;
102. Mitelea, I., Ghera, C., Bordeasu, I., Craciunescu, C.M. Ultrasonic cavitation erosion of a duplex treated 16MnCr5 steel, *INTERNATIONAL JOURNAL OF MATERIALS RESEARCH*, Volume: 106, Issue: 4, Pages: 391-397, ISSN: 18625282, eISSN: 21958556, 2015;
103. Moore, M., Gebert, A., Stoica, M., Uhlemann, M., Loser, W. A route for recycling Nd from NdFeB magnets using Cu melts, *Journal of Alloys and Compounds*, Volume: 647, Pages: 997-1006, ISSN: 09258388, eISSN: 18734669, 2015;
104. Muntean, S., Draghici, I., Ginga, G., Anton, L.E., Baya, A. Hydrodynamic Design of a Storage Pump Impeller using Inverse Method and Experimental Investigation of the Global Performances, *WASSERWIRTSCHAFT*, Volume: 105, Issue: 1, Special Issue: SI, Pages: 28-32, ISSN: 00430978, 2015;
105. Muscalagiu, I., Popa, H.E., Negru, V. Improving the Performances of Asynchronous Search Algorithms in Scale free Networks Using The No-good Processor Technique, *COMPUTING AND INFORMATICS*, Volume: 34, Issue: 1, Special Issue: SI, Pages: 254-274, ISSN: 13359150, 2015;
106. Musuc, A.M., Dumitru, R., Stan, A., Munteanu, C., Birjega, R., Carp, O. Synthesis, characterization and thermoreactivity of some methylcellulose/zinc composites, *JOURNAL OF THERMAL ANALYSIS AND CALORIMETRY*, Volume: 120, Issue: 1, Pages: 85-94, ISSN: 13886150, eISSN: 15728943, 2015;
107. Negrea, P., Caunii, A., Sarac, I., Butnariu, M. The Study of Infrared Spectrum of Chitin and Chitosan Extract as Potential Sources of Biomass, *DIGEST JOURNAL OF NANOMATERIALS AND BIOSTRUCTURES*, Volume: 10, Issue: 4, Pages: 1129-1138, ISSN: 1842-3582, 2015;
108. Negru, R., Marsavina, L., Voiconi, T., Linul, E., Filipescu, H., Belgiu, G. Application of TCD for brittle fracture of notched PUR materials, *THEORETICAL AND APPLIED FRACTURE MECHANICS*, Volume: 80, Pages: 87-95, Part: A, Special Issue: SI, ISSN: 0167-8442, eISSN: 1872-7638, 2015;
109. Niculescu, M., Magda, A., Jurca, M., Costea, L., Pode, V. Thermal and Kinetic Studies of the Polynuclear Coordination Compound Obtained Through the Reaction of 1,3propanediol with Ni(NO₃)(2) center dot 6 H₂O, *Revista de Chimie*, Volume: 66, Issue: 8, Pages: 1217-1221, ISSN: 00347752, 2015;
110. Nitulescu, A., Crisan-Vida, M., Stoicu-Tivadar, L., Bernad, E. Integrated wireless sensor network for monitoring pregnant women, *STUDIES IN HEALTH TECHNOLOGY AND INFORMATICS*, Volume: 210, Pages: 35-48, ISSN: 09269630, 2015;
111. Oancea, R., Bradu, A., Sinescu, C., Negru, R.M., Negrutiu, M.L., Antoniac, I., Duma, V.F., Podoleanu, A.G. Assessment of the sealant/tooth interface using optical coherence tomography, *JOURNAL OF ADHESION SCIENCE AND TECHNOLOGY*, Volume: 29, Issue: 1, Pages: 49-58, ISSN: 01694243, eISSN: 15685616, 2015;

112. Orha, C., Lazau, C., Dabici, A.M., Bandas, C., Olariu, S., Manea, F. Comparative photocatalytic performances of undoped/ndoped TiO₂ under solar irradiation for a reactive yellow 125 azo reactive dye degradation from water, ENVIRONMENTAL ENGINEERING AND MANAGEMENT JOURNAL, Volume: 14, Issue: 6, Pages: 1355–1360, ISSN: 15829596, eISSN: 18433707, 2015;
113. Osaci, M., Cacciola, M., An adapted Coffey model for studying susceptibility losses in interacting magnetic nanoparticles, BEILSTEIN JOURNAL OF NANOTECHNOLOGY, Volume: 6, Pages: 2173–2182, ISSN: 2190–4286, 2015;
114. Pacurariu, C., Taculescu, E.A., Ianos, R., Marinica, O., Mihali, C.V., Socoliuc, V. Synthesis and characterization of gammaFe₂O₃/SiO₂ composites as possible candidates for magnetic paper manufacture, CERAMICS INTERNATIONAL, Volume: 41, Issue: 1, Pages: 1079–1085, ISSN: 02728842, eISSN: 18733956, 2015;
115. Palade, A., Lascu, A., Creanga, Fagadar-Cosma, G., Birdeanu, M., Fagadar-Cosma, E. Triphenylphosphine Oxide Detection in Traces Using Mn(III)5,10,15,20-tetratolyl(21h, 23h Porphyrin Chloride, DIGEST JOURNAL OF NANOMATERIALS AND BIOSTRUCTURES, Volume: 10, Issue: 3, Pages: 729–735, ISSN: 18423582, 2015;
116. Pap, B., Gyorkei, A., Boboescu, I.Z., Nagy, I.K., Biro, T., Kondorosi, E., Maroti, G. Temperature dependent transformation of biogas producing microbial communities points to the increased importance of hydrogenotrophic methanogenesis under thermophilic operation, BIORESOURCE TECHNOLOGY, Volume: 177, Pages: 375–380, ISSN: 09608524, eISSN: 18732976, 2015;
117. Parthiban, R., Stoica, M., Kaban, I., Kumar, R., Eckert, J. Viscosity and fragility of the supercooled liquids and melts from the FeCoBSiNb and FeMoPCBSi glassforming alloy systems, : Intermetallics, Volume: 66, Pages: 48–55, ISSN: 09669795, 2015;
118. Pausescu, I., Medeleanu, M., Stefanescu, M., Peter, F., Pop, R. A DFT Study on the Stability and Aromaticity of Heterobenzenes Containing Group 15 Elements, HETEROATOM CHEMISTRY, Volume: 26, Issue: 3, Pages: 206–214, ISSN: 10427163, eISSN: 10981071, 2015;
119. Penta, S., Penta, V., Lucianu, B., Anghel, M., Argesanu, V. Thermographic Investigation of Ergonomic Medical Posture in Dentistry, REVISTA DE CHIMIE, Volume: 66, Issue: 7, Pages: 972–975, ISSN: 00347752, 2015;
120. Petrescu, C. Trainer's Choices in Teaching Translating / Interpreting, PROCEDIA – SOCIAL AND BEHAVIORAL SCIENCES, Elsevier, 2015;
121. Petrescu, C. Translating Ideology – A Teaching Challenge, PROCEDIA – SOCIAL AND BEHAVIORAL SCIENCES, Elsevier, 2015;
122. Pociovalisteanu, D.M., Novo Corti I., Aceleanu, M.I., Serban, A.C., Grecu, E. Employment Policies for a Green Economy at the European Union Level, SUSTAINABILITY, Volume: 7, Issue: 7, Pages: 9231–9250, ISSN: 20711050, 2015;
123. Pop, C. A Drift Free Left Invariant Control System on the Lie Group SO(3) x R³ x R³, MATHEMATICAL PROBLEMS IN ENGINEERING, ISSN: 1024123X, eISSN: 15635147, 2015;
124. Pop, R., Ilici, M., Andoni, M., Bercean, V.N., Muntean, C., Venter, M.M., Julean, I. Theoretical Considerations Regarding the Thionethiol Tautomerism in 2-(5-mercapto-1,3,4-thiadiazol-2-ylthio) acetic Acid, ACTA CHIMICA SLOVENICA, Volume: 62, Issue: 1, Pages: 814, ISSN: 13180207, eISSN: 15803155, 2015;
125. Popa, S., Padure, M., Gruescu, C.M., Boran, S. New Salicylic Acid-Based Azo Dyes Synthesis, Characterization and Colour Properties, REVISTA DE CHIMIE, Volume: 66, Issue: 12, Pages: 2021–2027, ISSN: 0034–7752, 2015;
126. Popov, D., Popov, M. Some operatorial properties of the generalized hypergeometric coherent states, PHYSICA SCRIPTA, Volume: 90, Issue: 3, ISSN: 00318949, eISSN: 14024896, 2015;
127. Popov, D., Shi-Hai D., Popov, M. Diagonal ordering operation technique applied to Morse oscillator, ANNALS OF PHYSICS, Volume 362, Pages 449 – 472, 2015;

128. Pozna, C., Precup, R.E., Foldesi, P. A novel pose estimation algorithm for robotic navigation, *ROBOTICS AND AUTONOMOUS SYSTEMS*, Volume: 63, Pages: 1021, ISSN: 09218890, eISSN: 1872793X, 2015;
129. Precup, R.E., Petriu, E.M., Radac, M.B., Preitl, S., Fedorovici, L.O., Dragos, C.A. cascade control system-based cost effective combination of tensor product model transformation and fuzzy control, *ASIAN JOURNAL OF CONTROL*, Volume: 17, Issue: 2, Pages: 381-391, ISSN: 15618625, eISSN: 19346093, 2015;
130. Precup, R.E., Sabau, M.C., Petriu, E.M. Nature inspired optimal tuning of input membership functions of Takagi Sugeno Kang fuzzy models for Antilock Braking Systems, *APPLIED SOFT COMPUTING*, Volume: 27, Pages: 575-589, ISSN: 15684946, eISSN: 18729681, 2015;
131. Precup, R.E., Tomescu, M.L. Stable fuzzy logic control of a general class of chaotic systems, *NEURAL COMPUTING & APPLICATIONS*, Volume: 26, Issue: 3, Special Issue: SI, Pages: 541-550, ISSN: 09410643, eISSN: 14333058, 2015;
132. Precup, R.E., Angelov, P., Costa, B.S.J., Sayed-Mouchaweh, M. An overview on fault diagnosis and nature-inspired optimal control of industrial process applications, *COMPUTERS IN INDUSTRY*, Volume: 74, Pages: 75-94, Special Issue: SI, ISSN: 0166-3615, eISSN: 1872-6194, 2015;
133. Precup, R.E., Tomescu, M.L., Petriu, E.M. A Unified Anti-Windup Technique for Fuzzy and Sliding Mode Controllers, *INTERNATIONAL JOURNAL OF COMPUTERS COMMUNICATIONS & CONTROL*, Volume: 10, Issue: 6, Pages: 843-855, Special Issue: SI, ISSN: 1841-9836, eISSN: 1841-9844, 2015;
134. Radac, M.B., Precup, R.E. Databased two degree of freedom iterative control approach to constrained nonlinear systems, *IET CONTROL THEORY AND APPLICATIONS*, Volume: 9, Issue: 7, Pages: 1000-1010, ISSN: 17518644, eISSN: 17518652, 2015;
135. Radac, M.B., Precup, R.E. Optimal behaviour prediction using a primitive-based data-driven model-free iterative learning control approach, *COMPUTERS IN INDUSTRY*, Volume: 74, Pages: 95-109, Special Issue: SI, ISSN: 0166-3615, eISSN: 1872-6194, 2015;
136. Radac, M.B., Precup, R.E., Petriu, E.M. Model-Free Primitive-Based Iterative Learning Control Approach to Trajectory Tracking of MIMO Systems With Experimental Validation, *IEEE TRANSACTIONS ON NEURAL NETWORKS AND LEARNING SYSTEMS*, Volume: 26, Issue: 11, Pages: 2925-2938, 2015;
137. Reboredo, J.C., Tiwari, A.K., Albulescu, C.T. (2015). An analysis of dependence between Central and Eastern European stock markets, *Economic Systems*, 39, 474-490, 2015;
138. Reisz, E., Naumov, S., Schmidt, W., von Sonntag, C. Reaction of Ozone with Ag(I)—Mechanistic Considerations, *OZONE: SCIENCE & ENGINEERING*, Volume 37(5), Pages 393-404, 2015;
139. Robu, R. The Analysis and Classification of Birth Data, *ACTA POLYTECHNICA HUNGARICA*, Volume: 12, Issue: 4, Pages: 77-96, ISSN: 17858860, 2015;
140. Robu, R., Holban, S., Robu, N. Ant miner extensions for improved data classification, *INTERNATIONAL JOURNAL OF COMPUTER ENGINEERING AND APPLICATIONS*, Volume IX, Issue VII, Part I, , pages 135-154, ISSN 2321-3469, 2015;
141. Ryu, J., Trifina, L., Balta, H. The limitation of permutation polynomial interleavers for turbo codes and a scheme for dithering permutation polynomials, *AEU INTERNATIONAL JOURNAL OF ELECTRONICS AND COMMUNICATIONS*, Volume: 69, Issue: 10, Pages: 5501-556, ISSN: 14348411, eISSN: 16180399. 2015;
142. Sabau, N.C., Man, T.E., Armas, A., Balaj, C., Giru, M. Characterization of agricultural droughts using Standardized Precipitation Index (SPI) and Bhalme-Mooley Drought Index (BDMI), *ENVIRONMENTAL ENGINEERING AND MANAGEMENT JOURNAL*, Volume: 14, Issue: 6, Pages: 1441-1454, ISSN: 15829596, eISSN: 18433707, 2015;
143. Sarac, B., Söpu, D., Park, E., Hufenbach, J.K., Oswald, S., Stoica, M., Eckert, J. Mechanical and Structural Investigation of Porous Bulk Metallic Glasses, *SOURCE: METALS*, Volume: 5, Issue: 2, Pages: 920-933, ISSN: 20754701, 2015;

144. Sarbu, I., Pacurar, C. Experimental and numerical research to assess indoor environment quality and schoolwork performance in university classrooms, *BUILDING AND ENVIRONMENT*, Volume: 93, Pages: 141-154, ISSN: 03601323, eISSN: 1873684X, 2015;
145. Sarbu, I., Sebarchievici, C. A study of the performances of low-temperature heating systems, *ENERGY EFFICIENCY*, Volume: 8, Issue: 3, Pages: 609-627, ISSN: 1570646X, eISSN: 15706478, 2015;
146. Sarbu, I., Valea, E.S. Energy Savings Potential for Pumping Water in District Heating Stations, *SUSTAINABILITY*, Volume: 7, Issue: 5, Pages: 5705-5719, ISSN: 20711050, 2015;
147. Sarbu, I.; Ostafe G., Optimal design of urban water supply pipe networks, *URBAN WATER JOURNAL*, (FI=1,794), 2015;
148. Sarbu, I.; Sebarchievici, C., General review of solar-powered closed sorption refrigeration systems, *ENERGY CONVERSION AND MANAGEMENT*, Volume. 105, no. 11, (FI=4,380), 2015;
149. Savva, I., Marinica, O., Papatryfonos, C.A., Vekas, L., Krasia-Christoforou, T. Evaluation of electrospun polymer/Fe₃O₄ nanocomposite mats in malachite green adsorption, *RSC ADVANCES*, Volume: 5, Issue: 21, Pages: 16484-16496, ISSN: 20462069, 2015;
150. Sebarchievici, C., Sarbu, I. Performance of an experimental ground-coupled heat pump system for heating, cooling and domestic hot-water operation, *RENEWABLE ENERGY*, Volume: 76, Pages: 148-159, ISSN: 09601481, 2015;
151. Segneanu, A.E., Grozescu, I., Cziple, F., Berki, D., Damian, D., Niculite, C.M., Florea, A., Leabu, M. Helleborus purpurascens-Amino Acid and Peptide Analysis Linked to the Chemical and Antiproliferative Properties of the Extracted Compounds, *MOLECULES*, Volume: 20, Issue: 12, Pages: 22170-22187, ISSN: 1420-3049, 2015;
152. Serban, A., Lupse, O.S., Stoicu-Tivadar, L. User experience integrated lifestyle cloud based medical application, *STUDIES IN HEALTH TECHNOLOGY AND INFORMATICS*, Volume: 210, Pages: 642-6, ISSN: 09269630, 2015;
153. Serban, D.A., Linul, E., Voiconi, T., Marsavina, L., Modler, N. Numerical evaluation of twodimensional micromechanical structures of anisotropic cellular materials: case study for polyurethane rigid foams, *IRANIAN POLYMER JOURNAL*, Volume: 24, Issue: 6, Pages: 515-529, ISSN: 10261265, eISSN: 17355265;
154. Serban, D.A., Marsavina, L., Modler, N. Low-cycle fatigue behaviour of polyamides, *FATIGUE & FRACTURE OF ENGINEERING MATERIALS & STRUCTURES*, Volume: 38 Issue: 11, Pages: 1383-1394, Special Issue: SI, 2015;
155. Serban, D.A., Voiconi, T., Linul, E., Marsavina, L., Modler, N. Viscoelastic Properties of PUR Foams Impact excitation and dynamic mechanical analysis, *MATERIALE PLASTICE*, Volume: 52, Issue: 4, Pages: 537-541, ISSN: 0025-5289, 2015;
156. Shahabi, H.S., Scudino, S., Kaban, I., Stoica, M., Rutt, U., Kuhn, U., Eckert, J. Structural aspects of elastoplastic deformation of a Zr based bulk metallic glass under uniaxial compression, *Acta Materialia*, Volume: 95, Pages: 30-36, ISSN: 13596454, eISSN: 18732453, 2015;
157. Sinescu, C., Negrutiu, M.L., Bradu, A., Duma, V.F., Podoleanu, A.G. Noninvasive Quantitative Evaluation of the Dentin Layer during Dental Procedures Using Optical Coherence Tomography, *COMPUTATIONAL AND MATHEMATICAL METHODS IN MEDICINE*, ISSN: 1748670X, eISSN: 17486718, 2015;
158. Söpu, D., Stoica, M., Eckert, J. Deformation behavior of metallic glass composites reinforced with shape memory nanowires studied via molecular dynamics simulations, *APPLIED PHYSICS LETTERS*, Volume: 106, Issue: 21, ISSN: 00036951, eISSN: 10773118, 2015;
159. Stangaciu, C., Micea, M., Cretu, V. An Analysis of a Hard Real-Time, Execution Environment Extension for Free RTOS, *ADVANCES IN ELECTRICAL AND COMPUTER ENGINEERING*, Volume: 15, Issue: 3, Pages: 79-86, ISSN: 15827445, eISSN: 18447600, 2015;

160. Stefan, O., Dragomir, T.L. A Control-aware QoS Adaptation Co-design Method for Networked Control Systems, *STUDIES IN INFORMATICS AND CONTROL*, Volume: 24, Issue: 1, Pages: 33-42, ISSN: 12201766, 2015;
161. Stefanescu, M., Bozdog, M., Muntean, C., Stefanescu, O., Vlase, T. Synthesis and magnetic properties of $\text{Co}_x\text{Zn}_{1-x}\text{Fe}_2\text{O}_4$ ($x=0$ divided by 1) nanopowders by thermal decomposition of Co(II), Zn(II) and Fe(III) carboxylates, *Journal of Magnetism and Magnetic Materials*, Volume: 393, Pages: 92-98, ISSN: 03048853, eISSN: 18734766, 2015;
162. Stefanescu, M., Sorescu, S., Susan-Resiga, D., Stefanescu, O., Vlase, G. Obtaining of NiO/SiO_2 by thermal decomposition of Ni(II) carboxylates formed within hybrid silica gels, : *JOURNAL OF THERMAL ANALYSIS AND CALORIMETRY*, Volume: 121, Issue: 1, Pages: 135-144, ISSN: 13886150, eISSN: 15728943, 2015;
163. Stoia, M., Muntean, C. Preparation, Characterization and Adsorption Properties Of MFe_2O_4 ($M = \text{Ni, Co, Cu}$) Nanopowders, *ENVIRONMENTAL ENGINEERING AND MANAGEMENT JOURNAL*, Volume: 14, Issue: 6, Pages: 1247-1259, ISSN: 15829596, eISSN: 18433707, 2015;
164. Stoia, M., Muntean, C., Militaru, B. Fine MnFe_2O_4 nanoparticles for potential environmental applications Synthesis and characterization *Journal of Thermal Analysis and Calorimetry*, Volume: 121, Issue: 3, Pages: 1003-1010, ISSN: 13886150, eISSN: 15728943, 2015;
165. Stoia, M., Pacurariu, C., Istratie, R., Niznansky, D. Solvothermal synthesis of magnetic $\text{Fe}_x\text{O}_y/\text{C}$ nanocomposites used as adsorbents for the removal of methylene blue from wastewater, *Journal of Thermal Analysis and Calorimetry*, Volume: 121, Issue: 3, Pages: 989-1001, ISSN: 13886150, eISSN: 15728943, 2015;
166. Stoian, C. *The Discourse of Tourism and National Heritage*. Newcastle upon Tyne: Cambridge Scholars Publishing, 2015;
167. Stoian, C. *The Romanian Alice in the Country of Marvels; Decipher the Charades in J. Lindseth (ed.) Alice in a World of Wonderlands/ The Translations of Lewis Carroll's Masterpiece*. Newcastle, DE: Oak Knoll Press, p. 457-60 (vol. 1 - eseu), p. 523-30 (vol. 2 – traducere inversă cu note), p. 671-87 (vol. 3 – listă verificare bibliografie cu E. Suff), 2015;
168. Stoian, C. *Meaning in Images: Complexity and Variation across Cultures in S. Starc, C. Jones și A. Maiorani (eds.) Meaning Making in Text*. London: Palgrave, p. 152-170, 2015;
169. Stoica, M., Ramasamy, P., Kaban, I., Scudino, S., Nicoara, M., Vaughan, G.B.M., Wright, J., Kumar, R., Eckert, J. Structure evolution of soft magnetic $(\text{Fe}_{36}\text{Co}_{36}\text{B}_{19.2}\text{Si}_{4.8}\text{Nb}_4)_{100x}$, Cu_x ($x=0$ and 0.5) bulk glassy alloys, *Acta Materialia*, Volume: 95, Pages: 335-342, ISSN: 13596454, eISSN: 18732453, 2015;
170. Stolojescu C., Isar, A. Ultrasound Images Conditioning, *REVUE ROUMAINE DES SCIENCES TECHNIQUESSERIE ELECTROTECHNIQUE ET ENERGETIQUE*, Volume: 60, Issue: 3, Pages: 303-312, ISSN: 00354066, 2015;
171. Sun GH., Popov, D., Camacho-Nieto, O. Dong S.H. Shannon information entropies for position-dependent mass Schrodinger problem with a hyperbolic well, *CHINESE PHYSICS B*, Volume: 24, Issue: 10, 2015;
172. Susan -Resiga, R., Ighisan, C., Muntean, S. A Mathematical Model for the Swirling Flow Ingested by the Draft Tube of Francis Turbines, *WASSERWIRTSCHAFT*, Volume: 105, Issue: 1, Special Issue: SI, Pages: 23-27, ISSN: 00430978, 2015;
173. Suta, L.M., Ledeti, I., Suci, L., Hadaruga, D., Fulias, A., Belu, I. Study Regarding the Behaviour of Encapsulated Piroxicam in Liquid Media, *REVISTA DE CHIMIE*, Volume: 66, Issue: 5, Pages: 718-721, ISSN: 00347752, 2015;
174. Szabo, R., Gontean, A. Robotic Arm Control Algorithm Based on Stereo Vision Using RoboRealm Vision, *ADVANCES IN ELECTRICAL AND COMPUTER ENGINEERING*, Volume: 15, Issue: 2, Pages: 65-74, ISSN: 15827445, eISSN: 18447600, 2015;
175. Telembici, T., Retezan, A., Florescu, C. Quantification of the Degree of Comfort given by Drinking Water Characteristics, *REVISTA DE CHIMIE*, Volume: 66, Issue: 1, Pages: 74-78, ISSN: 00347752, 2015;

176. Tiwari, A.K., Mutascu, M., Albulescu, C.T., Kyophilavong, P. Frequency domain causality analysis of stock market and economic activity in India, *INTERNATIONAL REVIEW OF ECONOMICS & FINANCE*, Volume: 39, Pages: 224-238, 2015;
177. Todea, A., Hiseni, A., Otten, L.G., Arends, I.W.C.E., Peter, F., Boeriu, C.G. Increase of stability of oleate hydratase by appropriate immobilization technique and conditions, *Journal of Molecular Catalysis Benzymatic*, Volume: 119, Pages: 40-47, ISSN: 13811177, eISSN: 18733158, 2015;
178. Todea, A., Otten, L.G., Frissen, A.E., Arends, I.W.C.E., Peter, F., Boeriu, C.G. Selectivity of lipases for estolides synthesis, *PURE AND APPLIED CHEMISTRY*, Volume: 87, Issue: 1, Pages: 51-58, ISSN: 00334545, eISSN: 13653075, 2015;
179. Todut, C., Dan, D., Stoian, V. Numerical and experimental investigation on seismically damaged reinforced concrete wall panels retrofitted with FRP composites, *COMPOSITE STRUCTURES*, Volume: 119, Pages: 648-665, ISSN: 02638223, eISSN: 18791085, 2015;
180. Tosa, D.J., Serban, V.A., Codrean, C., Buzdugan, D., Stoica, M. Dual phase bulk metallic glasses fabricated by hot pressing using two different types of glassy alloy powder, *JOURNAL OF OPTOELECTRONICS AND ADVANCED MATERIALS*, Volume: 17, Issue: 78, Pages: 1026-1031, ISSN: 14544164, eISSN: 18417132, 2015;
181. Totorean, A.F., Bosioc, A.I., Bernad, S.I., Susan-Resiga, R. Critical flow regions in the coronary bypass graft anastomosis, *PROCEEDINGS OF THE ROMANIAN ACADEMY SERIES AMATHEMATICS PHYSICS TECHNICAL SCIENCES INFORMATION SCIENCE*, Volume: 16, Issue: 2, Pages: 201-208, ISSN: 14549069, 2015;
182. Ursu, D., Gradinaru, V., Fahimi, B., Boldea, I. Six Phase BLDC Reluctance Machines: FEM Based Characterization and Four Quadrant Control, *IEEE TRANSACTIONS ON INDUSTRY APPLICATIONS*, Volume: 51, Issue: 3, Pages: 2105-2115, ISSN: 00939994, eISSN: 19399367, 2015;
183. Ursu, D., Miclau, M., Banica, R., Vaszilcsin, N. Impact of Fe doping on performances of CuGaO₂ p-type dye-sensitized solar cells, *MATERIALS LETTERS*, Volume: 143, Pages: 91-93, ISSN: 0167577X, eISSN: 18734979, 2015;
184. Ursu, D., Miclau, M., Banica, R., Vaszilcsin, N. In situ variable temperature Xray diffraction studies on Fe doped CuGaO₂ with applications in ptype dye sensitized solar cell, *JOURNAL OF OPTOELECTRONICS AND ADVANCED MATERIALS*, Volume: 17, Issue: 78, Pages: 938-942, ISSN: 14544164, eISSN: 18417132, 2015;
185. Utu, I.D., Marginean, G., Hulka, I., Serban, V.A., Cristea, D. Properties of the thermally sprayed Al₂O₃TiO₂ coatings deposited on titanium substrate, *INTERNATIONAL JOURNAL OF REFRACTORY METALS & HARD MATERIALS*, Volume: 51, Pages: 118-123, ISSN: 02634368, 2015;
186. Utu, I.D., Mitelea, I. SNMS investigations of thermally sprayed coatings, *MATERIALS TESTING*, Volume: 57, Issue: 3, Pages: 267-272, ISSN: 00255300, 2015;
187. Vaida, M., Duteanu, N., Grozescu, I. Preparation and characterization of the thermoelectric material Zn₄Sb₃, *JOURNAL OF OPTOELECTRONICS AND ADVANCED MATERIALS*, Volume: 17, Issue: 78, Pages: 1021-1025, ISSN: 14544164, eISSN: 18417132, 2015;
188. Vlazan, P., Ursu, D.H., Irina Moiescu, C., Miron, I., Sfirloaga, P., Rusu, E. Structural and electrical properties of TiO₂/ZnO core-shell nanoparticles synthesized by hydrothermal method, *MATERIALS CHARACTERIZATION*, Volume: 101, Pages: 153-158, ISSN: 10445803, eISSN: 18734189, 2015;
189. Voda, R., Negrea, A., Lupa, L., Ciopec, M., Negrea, P., Davidescu, C.M., Butnariu, M. Nanocrystalline ferrites used as adsorbent in the treatment process of waste waters resulted from ink jet cartridges manufacturing, *OPEN CHEMISTRY*, Volume: 13, Issue: 1, Pages: 743-747, ISSN: 23915420, 2015;
190. Voicu, A., Duteanu, N., Raduta, A., Vaszilcsin, N. Influence of Electrochemical Treatment over Cellular Adherence onto the Surface of Titanium Surgical Implants, *INTERNATIONAL JOURNAL OF ELECTROCHEMICAL SCIENCE*, Volume: 10, Issue: 7, Pages: 5624-5638, ISSN: 14523981, 2015;
191. Wachter, MR., Ionel, I., Negrea, A., Cebucean, D., Manzatu, V., Ciopec, M. Leaching Investigation of Coal Fly Ash and Dry Desulphurisation Residues by Stabilization into Ash Rock, *REVISTA DE CHIMIE*, Volume: 66, Issue: 11, Pages: 1881-1884, ISSN: 0034-7752, 2015;
192. Yi, J.Z., Mao, X., Chen, L.J., Xue, Y.L., Rovetta, A., Căleanu, C.D. Illumination Normalization of Face Image Based on Illuminant Direction Estimation and Improved Retinex, *PLoS One*, Volume: 10, Issue: 4, ISSN: 19326203, 2015;

ISI Proceedings

Papers in ISI Proceedings

1. Adam, A., Cosma, C., Comsa, A., Pop, A. Redesigning a product using modern CAD/CAM Software, 8TH INTERNATIONAL CONFERENCE INTERDISCIPLINARITY IN ENGINEERING, INTERENG 2014, Procedia Technology, Volume: 19, Pages: 221-227, 8th International Conference on Interdisciplinarity in Engineering (InterEng), Tirgu Mures, Romania, ISSN: 22120173, Published 2015;
2. Albulescu, C.T. Banks' Profitability and Financial Soundness Indicators: A MacroLevel Investigation in Emerging Countries, 2ND GLOBAL CONFERENCE ON BUSINESS, ECONOMICS, MANAGEMENT AND TOURISM, Procedia Economics and Finance, Volume: 23, Pages: 203-209, 2nd Global Conference on Business, Economics and Management and Tourism (BEMTUR), Prague, Czech Republic, ISSN: 22125671, Published 2015;
3. Albulescu, C.T. Do Foreign Direct and Portfolio Investments Affect LongTerm Economic Growth in Central and Eastern Europe? 2ND GLOBAL CONFERENCE ON BUSINESS, ECONOMICS, MANAGEMENT AND TOURISM, Procedia Economics and Finance, Volume: 23, Pages: 507-512, 2nd Global Conference on Business, Economics and Management and Tourism (BEMTUR), Prague, Czech Republic, ISSN: 22125671, Published 2015;
4. Alionescu, A., Herban, I.S., Vilceanu, C.B., Musat, C.C. Mathematic Interpolation Methods Support for an Efficient 3D Modeling of Landslides in the Context of Displacements Monitoring, PROCEEDINGS OF THE INTERNATIONAL CONFERENCE OF NUMERICAL ANALYSIS AND APPLIED MATHEMATICS 2014 (ICNAAM2014), AIP Conference Proceedings, Volume: 1648, Article Number: UNSP 670002, International Conference on Numerical Analysis and Applied Mathematics (ICNAAM), Rhodes, Greece, ISSN: 0094243X, ISBN: 9780735412873, Published 2015;
5. Ancusa, V., Bogdan, R., Caus, O. A Complex NetworkBased Visual Analysis of Business Tendency and Consumer Opinion Surveys, PROCEEDINGS OF THE 14TH EUROPEAN CONFERENCE ON RESEARCH METHODOLOGY FOR BUSINESS AND MANAGEMENT STUDIES (ECRM 2015), European Conference on Research Methodology for Business and Management, Pages: 10-14, 11-12 June 2015, Univ Malta, Valletta, Malta, ISSN: 20490968, ISBN: 9781910810125, Published 2015;
6. Ancusa, V. Complex Network-Based Word Analysis in Academic Inter-personal Communication. A Case Study, International Conference on Social Media in Academia - Research and Teaching (SMART), Pages: 375-382, Timisoara, ROMANIA, ISBN:978-88-7587-712-5, Published: 2015;
7. Ardelean, E., Ardelean, M., Heput, T., Lascutoni, A. Technological aspects at continuous casting of semifinished products with phi 270mm, INTERNATIONAL CONFERENCE ON APPLIED SCIENCES 2014 (ICAS2014), IOP Conference Series Materials Science and Engineering, Volume: 85, Article Number: 012002, International Conference on Applied Sciences (ICAS), Engn Fac Hunedoara, Hunedoara, Romania, ISSN: 17578981, Published 2015;
8. Artene, A.E., Domil, A.E., Puscas, A., Domil, M., Gencia, A. The Role of Accounting Information for a Sustainable Development within Farming Entities in Romania Case Study Banat Region, INNOVATION VISION 2020: FROM REGIONAL DEVELOPMENT SUSTAINABILITY TO GLOBAL ECONOMIC GROWTH, VOL IVI, Pages: 1655-1665, 25th International Business Information Management Association Conference, 07-08 May 2015, Conference Location: Amsterdam, Netherlands, ISBN: 9780986041945, Published 2015;
9. Baesu, V., Albulescu, C.T., Farkas, Z.B., Draghici, A. Determinants of the high-tech sector innovation performance in the European Union: a review, 8TH INTERNATIONAL CONFERENCE INTERDISCIPLINARITY IN ENGINEERING, INTERENG 2014, Procedia Technology, Volume: 19, Pages: 371-378, 8th International Conference on Interdisciplinarity in Engineering (InterEng), Tirgu Mures, Romania, ISSN: 22120173, Published 2015;
10. Baesu, V., Marian, L., Farkas, Z.B., Draghici, A. Education evaluation a proposed approach for the technical schools in Romania, 8TH INTERNATIONAL CONFERENCE INTERDISCIPLINARITY IN ENGINEERING, INTERENG 2014, Procedia Technology, Volume: 19, Pages: 1115-1122, 8th International Conference on Interdisciplinarity in Engineering (InterEng), Tirgu Mures, Romania, ISSN: 22120173, Published 2015;
11. Banciu, F.V., Pamintas, E. Theory practice, a nonfunctional tandem in Romanian Technical Higher Education, 8TH INTERNATIONAL CONFERENCE INTERDISCIPLINARITY IN ENGINEERING, INTERENG 2014, Procedia Technology, Volume: 19, Pages: 1130-1135, 8th International Conference on Interdisciplinarity in Engineering (InterEng), Tirgu Mures, Romania, ISSN: 22120173, Published 2015;
12. Banica, R., Ursu, D., Racu, A.V., Vaszilcsin, N. Hydrothermal Synthesis of Zn(2)S(4) Microspheres Under Controlled Pressure, NANOCON 2014, 6TH INTERNATIONAL CONFERENCE, Pages: 208-213, 6th NANOCON International Conference, Brno, Czech Republic, ISBN: 9788087294536, Published 2015;

13. Benea, M.L., Benea, L.P. Characterization of the WC coatings deposited by plasma spraying Source: INTERNATIONAL CONFERENCE ON APPLIED SCIENCES 2014 (ICAS2014) Book Series Title: IOP Conference Series Materials Science and Engineering, Volume: 85, Article Number: 012004, International Conference on Applied Sciences (ICAS), Engrn Fac Hunedoara, Hunedoara, Romania, ISSN: 17578981, Published 2015;
14. Berghian, A.B., Vasii, T. Determination of reliability for Dacia 1304 1,9 D utility vehicle, INTERNATIONAL CONFERENCE ON APPLIED SCIENCES 2014 (ICAS2014), IOP Conference Series Materials Science and Engineering, Volume: 85, Article Number: 012007, International Conference on Applied Sciences (ICAS), Engrn Fac Hunedoara, Hunedoara, Romania, ISSN: 17578981, Published 2015;
15. Birdeanu, M., Birdeanu, A.V., Popa, I., Taranu, B., Peter, F., Creanga, I., Palade, A., Fagadar-Cosma, E. Comparative research regarding corrosion protective effect of different sandwich type nanostructures obtained From porphyrins and pseudobinary oxides by changing the deposition order, NANOCON 2014, 6TH INTERNATIONAL CONFERENCE, Pages: 262-267, 6th NANOCON International Conference, Brno, Czech Republic, ISBN: 9788087294536, Published 2015;
16. Bistriian, D.A. Reconstruction of Perturbed Pressure Field in a Hydraulic Turbine by Reduced Order Modeling Techniques, PROCEEDINGS OF THE INTERNATIONAL CONFERENCE OF NUMERICAL ANALYSIS AND APPLIED MATHEMATICS 2014 (ICNAAM2014), AIP Conference Proceedings, Volume: 1648, Article Number: 050005, International Conference on Numerical Analysis and Applied Mathematics (ICNAAM), Rhodes, Greece, ISSN: 0094243X, ISBN: 9780735412873, Published 2015;
17. Boatca, M.E., Cirjaliu, B. A Proposed Approach for an Efficient Ergonomics Intervention in Organizations, 2ND GLOBAL CONFERENCE ON BUSINESS, ECONOMICS, MANAGEMENT AND TOURISM, Procedia Economics and Finance, Volume: 23, Pages: 54-62, 2nd Global Conference on Business, Economics and Management and Tourism (BEMTUR), Prague, Czech Republic, ISSN: 22125671, Published 2015;
18. Boatca, M.E., Danciu, M.I., Irimie, S. Corporate Sustainability through Ergonomics Intervention: Study on Utilitarian Alpinist Occupation In Romania, INNOVATION VISION 2020: FROM REGIONAL DEVELOPMENT SUSTAINABILITY TO GLOBAL ECONOMIC GROWTH, VOL IVI, Pages: 1925-1932, 25th International Business Information Management Association Conference, 07-08 May 2015, Conference Location: Amsterdam, Netherlands, ISBN: 9780986041945, Published 2015;
19. Bordeasu, I., Popoviciu, M.O., Micu, L.M., Oanca, O.V., Bordeasu, D., Pugna, A., Bordeasu, C. Laser beam treatment effect on AMPCO M4 bronze cavitation erosion resistance, INTERNATIONAL CONFERENCE ON APPLIED SCIENCES 2014 (ICAS2014), IOP Conference Series Materials Science and Engineering, Volume: 85, Article Number: 012005, International Conference on Applied Sciences (ICAS), Engrn Fac Hunedoara, Hunedoara, Romania, ISSN: 17578981, Published 2015;
20. Botea, T., Cismariu, L. Social media channels in organizational communication, International Conference on Social Media in Academia - Research and Teaching (SMART), Pages: 361-365, Timisoara, ROMANIA, ISBN:978-88-7587-712-5, Published: 2015;
21. Boussaibo, A., Kamta, M., Kayem, J., Toader, D., Haragus, S., Maghet, A. Characterization of Photovoltaic Pumping System Model Without Battery Storage by Matlab/Simulink, 9th International Symposium on Advanced Topics in Electrical Engineering (ATEE), Pages: 774-780, Bucharest, ROMANIA, MAY 07-09, 2015, ISBN:978-1-4799-7514-3, Published 2015;
22. Bularda, N, Weber, F., Crisan, E. Mathematical Modeling Concerning the Cumulative Influence of the Alloying Elements for Aluminum Alloy 6082 on the Physical and Mechanical Characteristics, PROCEEDINGS OF THE INTERNATIONAL CONFERENCE OF NUMERICAL ANALYSIS AND APPLIED MATHEMATICS 2014 (ICNAAM2014), AIP Conference Proceedings, Volume: 1648, Article Number: UNSP 680003, International Conference on Numerical Analysis and Applied Mathematics (ICNAAM), Rhodes, Greece, ISSN: 0094243X, ISBN: 9780735412873, Published 2015;
23. Bularda, N., Heput, T. Mathematical Modeling Concerning the Influence of Chemical Composition of the 6082 Aluminum Alloy on Physical and Mechanical Characteristics, PROCEEDINGS OF THE INTERNATIONAL CONFERENCE OF NUMERICAL ANALYSIS AND APPLIED MATHEMATICS 2014 (ICNAAM2014), AIP Conference Proceedings, Volume: 1648, Article Number: UNSP 680002, International Conference on Numerical Analysis and Applied Mathematics (ICNAAM), Rhodes, Greece, ISSN: 0094243X, ISBN: 9780735412873, Published 2015;
24. Cacciola, M., Osaci, M. Studies about the attempt frequency influence on the effective relaxation time in a system of nanoparticles for magnetic hyperthermia, INTERNATIONAL ONFERENCE ON APPLIED SCIENCES 2014 (ICAS2014), IOP Conference Series Materials Science and Engineering, Volume: 85, Article Number: 012021, International Conference on Applied Sciences (ICAS), Engrn Fac Hunedoara, Hunedoara, Romania, ISSN: 17578981, Published 2015;

25. Cernicova, M., Dragomir, M., Palea, A. A Students' and Professors' View on the Image of Their University. Case Study: Politehnica University of Timisoara, *Procedia - Social and Behavioral Sciences* vol. 191, Elsevier ScienceDirect, Malta, Malta, ISSN 1877-0428, p. 98-102, 2015;
26. Cernicova, M., Palea, A. Digital competences for PR specialists, seen through the lenses of online recruitment announcements. A view from Romania, *International Conference on Social Media in Academia - Research and Teaching (SMART)*, Pages: 239-243, Timisoara, ROMANIA, ISBN:978-88-7587-712-5, Published: 2015;
27. Cernicova, M., Palea, A. Measuring the Students' Perception Chosen Profession. Case Study: PR Students in Western Romania, *Procedia - Social and Behavioral Sciences*, VOL. 116, Elsevier ScienceDirect, Roma, Italy, p. 2825-2831, ISSN 1877-0428, Published 2015;
28. Cernicova-Buca, M. Religious media relations in post-communist Romania. Case study: PR practices of religious denominations in Timis County, Elsevier ScienceDirect, Montpellier, France, 2014-10-15, p. 295-304, *Espace public et communication de la foi*, 2nd International Conference ComSymbol on "Public Sphere and Communicating Faith", ISBN 978-2-9532450-2-8, Published 2015;
29. Cernicova-Buca, M. Strategies for promoting sport clubs in the web 2.0 era. A Romanian view, Albena, Bulgaria, ISBN 978-619-7105-44-5, 2015, 903, 909, *Conference proceedings: Psychology and Psychiatry, Sociology and Healthcare*, 2nd International Multidisciplinary Scientific Conference on Social Sciences and Arts SGEM 2015, 2015;
30. Cernicova-Buca, M. Universities and their identity in the 21st century, Albena, Bulgaria, ISBN 978-619-7105-45-2, 2015, 1147, 1154, *Conference Proceedings: Education and Educational Research*, 2nd International Multidisciplinary Scientific Conference on Social Sciences and Arts SGEM 2015, 2015;
31. Chioncel, CP., Erdodi, GM., Petrescu, DI., Spunei, E., Gillich, N. Control of Wind Power Systems Imposing the Current in the Intermediate Circuit of the Converter at Variable Wind Speed, 9th International Symposium on Advanced Topics in Electrical Engineering (ATEE), Pages: 923-928, Bucharest, ROMANIA, MAY 07-09, 2015, Published 2015;
32. Chirila, CB. Towards generative learning objects on microblogging platforms, *International Conference on Social Media in Academia - Research and Teaching (SMART)*, Pages: 93-98, Timisoara, ROMANIA, ISBN:978-88-7587-712-5, Published: 2015;
33. Chiru, C., Ancusa, V., Bogdan, R., Tănase, D., Popa, M. A Method for Levelling Business and Academic Narratives Representation, *Proceedings of the 12th International Conference on Intellectual Capital, Knowledge Management & Organisational Learning (ICICKM 2015)*, Bangkok, Thailand, pp. 65-71. Kidmore End: Academic Conferences International Limited, 2015;
34. Cirjaliu, B., Draghici, A. The Economic Effectiveness Related To A Qualitative Ergonomic Intervention: Case Study on an International Transport Company, *INNOVATION VISION 2020: FROM REGIONAL DEVELOPMENT SUSTAINABILITY TO GLOBAL ECONOMIC GROWTH*, VOL IVI, Pages: 1504-1511, 25th International Business Information Management Association Conference, 07-08 May 2015, Conference Location: Amsterdam, Netherlands, ISBN: 9780986041945, Published 2015;
35. Cismariu, L., Stanciu, A., Stanciu, LM., Polana, NR. Strategies from Social Media Used by Entrepreneurs in the Context of the Economic Crisis, *International Conference on Social Media in Academia - Research and Teaching (SMART)*, Pages: 99-104, Timisoara, ROMANIA, ISBN:978-88-7587-712-5, Published: 2015;
36. Crisan, M. Approximation Neural Network for Phoneme Synthesis, *PROCEEDINGS OF THE 3RD INTERNATIONAL CONFERENCE ON FRONTIERS OF INTELLIGENT COMPUTING: THEORY AND APPLICATIONS, (FICTA) 2014, VOL 1*, *Advances in Intelligent Systems and Computing*, Volume: 327, Pages: 18, 3rd International Conference on Frontiers in Intelligent Computing Theory and Applications (FICTA), Bhubaneswar, India, ISSN: 21945357, ISBN: 9783319119328, Published: 2015;
37. Danciu, M.I., Irimie, S., Boatca, M.E. Strategic Social Entrepreneurship between Public and Corporate Management In The Context of Former Romanian Mining Colonies, *INNOVATION VISION 2020: FROM REGIONAL DEVELOPMENT SUSTAINABILITY TO GLOBAL ECONOMIC GROWTH*, VOL IVI, Pages: 1950-1959, 25th International Business Information Management Association Conference, 07-08 May 2015, Conference Location: Amsterdam, Netherlands, ISBN: 9780986041945, Published 2015;
38. Dinis, C.M., Popa, G.N., Iagar, A. Study on sources of charging lead acid batteries, *INTERNATIONAL CONFERENCE ON APPLIED SCIENCES 2014 (ICAS2014)*, IOP Conference Series Materials Science and Engineering, Volume: 85, Article Number: 012011, International Conference on Applied Sciences (ICAS), Engn Fac Hunedoara, Hunedoara, Romania, ISSN: 17578981, Published 2015;

39. Draghici, A., Baban, C.F., Gogan, M.L., Ivascu, L.V. A Knowledge Management Approach for the University Industry Collaboration in Open Innovation, 2ND GLOBAL CONFERENCE ON BUSINESS, ECONOMICS, MANAGEMENT AND TOURISM, *Procedia Economics and Finance*, Volume: 23, Pages: 23-32, 2nd Global Conference on Business, Economics and Management and Tourism (BEMTUR), Prague, Czech Republic, ISSN: 22125671, Published 2015;
40. Dragulescu, B., Bucos, M., Vasii, R. CVLA: Integrating Multiple Analytics Techniques in a Custom Moodle Report, 21st International Conference on Information and Software Technologies (ICIST), Book Series: Communications in Computer and Information Science, Volume: 538, Pages: 115-126, Druskininkai, LITHUANIA, OCT 15-16, 2015, ISBN:978-3-319-24770-0; 978-3-319-24769-4, ISSN: 1865-0929, Published 2015;
41. Duma, V.F., Tankam, P., Huang, J.X., Won, J., Rolland, J.P. Effective duty cycle of galvanometer-based scanners: Impact on OCT imaging, DESIGN AND QUALITY FOR BIOMEDICAL TECHNOLOGIES VIII, Proceedings of SPIE, Volume: 9315, Article Number: 93150J, Conference on Design and Quality for Biomedical Technologies VIII, 07-08 February 2015, San Francisco, CA, ISSN: 0277786X, ISBN: 9781628414059, Published 2015;
42. Duma, V.F., Dobre, G., Demian, D., Cernat, R., Sinescu, C., Negrutiu, M.L., Hutiu, G., Bradu, A., Rolland, J.P., Podoleanu, A. Constructive solutions of handheld probes with galvanometer scanners for biomedical and industrial imaging. Applications in OCT, Conference on OPTIFAB 2015, Book Series: Proceedings of SPIE, Volume: 9633, Article Number: 96330Q, Rochester, NY, USA, OCT 12-15, 2015, ISBN:978-1-62841-838-5, ISSN: 0277-786X, Published 2015;
43. Duran, D.C., Gogan, L.M., Duran, V. A Possible Approach for Managing Bonds Portfolio, 2ND GLOBAL CONFERENCE ON BUSINESS, ECONOMICS, MANAGEMENT AND TOURISM
44. Ene, R.D., Marinca, V., Marinca, B. Free oscillations of a nonlinear oscillator with an exponential non-viscous damping, Book Series: Applied Mechanics and Materials, Vol. 801, pp. 38--42, Published 2015;
45. Fitigau, I.F., Boeriu, C.G., Peter, F. Enzymatic Modification of Different Lignins Through Oxidative Coupling with Hydrophilic Compounds, MACROMOLECULAR SYMPOSIA, Volume: 352, Issue: 1, Special Issue: SI, Pages: 78-86, 15th International Conference on Polymers and Organic Chemistry (POC), Timisoara, Romania, ISSN: 10221360, eISSN: 15213900, Published 2015;
46. Flori, M., Vilceanu, L. CFD numerical simulation of air natural convection over a heated cylindrical surface, INTERNATIONAL CONFERENCE ON APPLIED SCIENCES 2014 (ICAS2014), IOP Conference Series Materials Science and Engineering, Volume: 85, Article Number: 012012, International Conference on Applied Sciences (ICAS), Engn Fac Hunedoara, Hunedoara, Romania, ISSN: 17578981, Published 2015;
47. Fuicu, S., Avramescu, A., Lascu, D., Padurariu, R., Marcu, M. Assistive E-Health Platform for Permanent Monitoring, ICTS FOR IMPROVING PATIENTS REHABILITATION RESEARCH TECHNIQUES, REHAB 2014, Book Series: Communications in Computer and Information Science, Volume: 515, Pages: 35-44, Oldenburg, GERMANY, ISBN:978-3-662-48645-0; 978-3-662-48644-3, ISSN: 1865-0929, Published 2015;
48. Fulias, A., Vlase, G., Todea, A., Vlase, T., Ledeti, I. Thermal Characterization of Polymeric Coatings for Pharmaceutical Dosage Forms, MACROMOLECULAR SYMPOSIA, Volume: 352, Issue: 1, Special Issue: SI, Pages: 59-65, 15th International Conference on Polymers and Organic Chemistry (POC), Timisoara, Romania, ISSN: 10221360, eISSN: 15213900, Published 2015;
49. Gherheș, V., Petcu, D., Suci, S., Obrad, C. The Legal Background and the Policies Promoting the Cultural Identity of Ethnic Minorities In Romania, International Conference: Cultural Expressions and European Identities, ISBN:978-2-8027-3563-2, Published 2015;
50. Gherman, V.D., Boboescu, I.Z., Ilie, M., Molnar, P., Hulka, I., Maroti, G. Pilot bioreactor system for rapid test of different industrial wastewater efficiency in hydrogen production through dark fermentation, JOURNAL OF BIOTECHNOLOGY, Volume: 208, Pages: S118-S118, European Biotechnology Congress, May 2015, Bucharest, Romania, ISSN: 01681656, eISSN: 18734863, Published 2015;
51. Gogan, L.M., Duran, D.C., Draghici, A. Structural capital A proposed measurement model, 2ND GLOBAL CONFERENCE ON BUSINESS, ECONOMICS, MANAGEMENT AND TOURISM, *Procedia Economics and Finance*, Volume: 23, Pages: 1139-1146, 2nd Global Conference on Business, Economics and Management and Tourism (BEMTUR), Prague, Czech Republic, ISSN: 22125671, Published 2015;
52. Gogan, M.L., Sirbu, R.M., Drahici, A. Aspects concerning the use of the Moodle platform Case Study, 8TH INTERNATIONAL CONFERENCE INTERDISCIPLINARITY IN ENGINEERING, INTERENG 2014, *Procedia Technology*, Volume: 19, Pages: 1142-1148, 8th International Conference on Interdisciplinarity in Engineering (InterEng), Tirgu Mures, Romania, ISSN: 22120173, Published 2015;

53. Hanke, U., Lovasz, E.C., Zichner, M., Modler, N., Comsa, A., Modler, K.H., Synthesis of PR/RPChain Based Compliant Mechanisms: Design of Applications Exploiting Fibre Reinforced Material Characteristics, NEW TRENDS IN MECHANISM AND MACHINE SCIENCE: FROM FUNDAMENTALS TO INDUSTRIAL APPLICATIONS, Mechanisms and Machine Science, Volume: 24, Pages: 743-751, 5th European Conference on Mechanism Science (EUCOMES), Univ Minho, Guimaraes, Portugal, ISSN: 22110984, ISBN: 9783319094106, Published 2015;
54. Holotescu, C. Using Design Based Research for Building Open Learning Platforms, International Conference on Social Media in Academia - Research and Teaching (SMART), Pages: 423-428, Timisoara, ROMANIA, ISBN:978-88-7587-712-5, Published: 2015;
55. Holotescu, C., Pepler, G. Opening up education in Romania, International Conference on Social Media in Academia - Research and Teaching (SMART), Pages: 383-387, Timisoara, ROMANIA, ISBN:978-88-7587-712-5, Published: 2015;
56. Iagar, A., Popa, G.N., Dinis, C.M. Analysis the electrical parameters of a high frequency coreless induction furnace, INTERNATIONAL CONFERENCE ON APPLIED SCIENCES 2014 (ICAS2014), Book Series Title: IOP Conference Series Materials Science and Engineering, Volume: 85. Article Number: 012013, International Conference on Applied Sciences (ICAS), Engn Fac Hunedoara, Hunedoara, Romania, ISSN: 17578981, Published 2015;
57. Iapa, AC. MOOC and Learning Analytics: interaction and evolution, International Conference on Social Media in Academia - Research and Teaching (SMART), Pages: 55-59, Timisoara, ROMANIA, ISBN:978-88-7587-712-5, Published: 2015;
58. Ionescu, D., Kovaci, M. "Performances of the planar ferrite phase shifters based on microwave garnets", IEEE 11th International Symposium on Electronics and Telecommunications (ISETC2014), 14-15 Nov, Timisoara 2014, ISBN: 978-1-4799-7267-8, 2015;
59. Ionescu, D., Kovaci, M. "The Shape Factor Influence on the Control Process of Multiferroic Nanoparticle Configurations in GHz Range", 3rd edition of Modern technologies in industrial engineering International Conference (ModTech2015), 17-20 June, 2015, Mamaia, Romania, Book Series: IOP Conference Series-Materials Science and Engineering, Volume: 95, ISSN: 1757-8981, 2015;
60. Ionescu, D., Kovaci, M. "Waveguide digital phase shifters filled with TT1 to TT86 ferrites for UHF and SHF radio bands-Parameter optimization", IEEE 11th International Symposium on Electronics and Telecommunications (ISETC2014), 14-15 Nov, Timisoara 2014, ISBN: 978-1-4799-7267-8, 2015;
61. Ionescu, D., Kovaci, M., "Field Control of Multiferroic Spherical Core-Shell Nanocomposites with Applications in Microwave Range", 3rd edition of Modern technologies in industrial engineering International Conference (ModTech2015), 17-20 June, 2015. Mamaia, Romania, Book Series: IOP Conference Series-Materials Science and Engineering, Volume: 95, ISSN: 1757-8981, 2015;
62. Ivascu, A.L., Cioca, L.I. From Theory to Practice: Evolution of Sustainable Development in Organizations, INNOVATION VISION 2020: FROM REGIONAL DEVELOPMENT SUSTAINABILITY TO GLOBAL ECONOMIC GROWTH, VOL IVI, Pages: 725-733, 25th International Business Information Management Association Conference, 07-08 May 2015, Conference Location: Amsterdam, Netherlands, ISBN: 9780986041945, Published 2015;
63. Josan, A., Bretotean, C.P. Using special additions to preparation of the moulding mixture for casting steel parts of drive wheel type, INTERNATIONAL CONFERENCE ON APPLIED SCIENCES 2014 (ICAS2014), IOP Conference Series Materials Science and Engineering, Volume: 85, Article Number: 012017, International Conference on Applied Sciences (ICAS), Engn Fac Hunedoara, Hunedoara, Romania, ISSN: 17578981, Published 2015;
64. Josan, A., Bretotean, C.P., Ardelean, E., Ardelean, M. Using lateral cores to casting of carbon steel parts, of drive wheel type, in a metallurgical enterprise, INTERNATIONAL CONFERENCE ON APPLIED SCIENCES 2014 (ICAS2014), IOP Conference Series Materials, Science and Engineering, Volume: 85, Article Number: 012016, International Conference on Applied Sciences (ICAS), Engn Fac Hunedoara, Hunedoara, Romania, ISSN: 17578981, Published 2015;
65. Kherbach, O., Mocan, M.L., Dumitrache, C. A Survey on Implementation of The Lean Manufacturing in Local SMEs, 26th International-Business-Information-Management-Association Conference, INNOVATION MANAGEMENT AND SUSTAINABLE ECONOMIC COMPETITIVE ADVANTAGE: FROM REGIONAL DEVELOPMENT TO GLOBAL GROWTH, VOLS I - VI, 2015, Pages: 1635-1643, Madrid, SPAIN, NOV 11-12, 2015, Published: 2015;
66. Kovaci, M., Balta H., "Turbo codes performance on Rice flat fading environment", 11th International Symposium on Electronics and Telecommunications (ISETC2014), 14-15 Nov, Timisoara 2014, ISBN: 978-1-4799-7267-8, 2015;

67. Latinovic, T.S., Deaconu, S.I., Latinovic, M.T., Malesevic, N., Barz, C. Develop virtual joint laboratory for education like distance engineering system for robotic applications, INTERNATIONAL CONFERENCE ON APPLIED SCIENCES 2014 (ICAS2014), IOP Conference Series Materials Science and Engineering, Volume: 85, Article Number: 012018, International Conference on Applied Sciences (ICAS), Engn Fac Hunedoara, Hunedoara, Romania, ISSN: 17578981, Published 2015;
68. Lelea, D., Calinoiu, D.G., Trif-Tordai, G., Cioabla, A.E., Laza, L., Popescu, F. The Hybrid Nanofluid/Microchannel Cooling Solution for Concentrated Photovoltaic Cells, INTERNATIONAL CONFERENCES AND EXHIBITION ON NANOTECHNOLOGIES & ORGANIC ELECTRONICS (NANOTEXNOLOGY 2014), AIP Conference Proceedings, Volume: 1646, Pages: 122-128, International Conferences and Exhibition on Nanotechnologies and Organic Electronics (NANOTEXNOLOGY), Thessaloniki, Greece, ISSN: 0094243X, ISBN: 9780735412859, Published 2015;
69. Lovasz, E.C., Perju, D., Modler, K.H., Gruescu, C.M., Margineanu, D., Moldovan, C.E., Pop, C. Path Generating Belt Mechanisms as Kinematic Chains for Mechatronic Applications, NEW TRENDS IN MECHANISM AND MACHINE SCIENCE: FROM FUNDAMENTALS TO INDUSTRIAL APPLICATIONS, Mechanisms and Machine Science, Volume: 24, Pages: 111-119, 5th European Conference on Mechanism Science (EUCOMES), Univ Minho, Guimaraes, Portugal, ISSN: 22110984, ISBN: 9783319094106, Published 2015;
70. Margineanu, D., Lovasz, E.C., Modler, K.H., Gruescu, C.M. Steering and Non-steering Crawling Tetrahedral Micro-mechanisms, 3rd Conference on Microactuators and Micromechanisms (MAMM), Book Series: Mechanisms and Machine Science, Volume: 30, Pages: 9-22, Timisoara, ROMANIA, ISBN:978-3-319-15862-4; 978-3-319-15861-7, ISSN: 2211-0984, Published 2015;
71. Margineanu, D., Lovasz, E.C., Modler, N. Multibody System Simulation of Hysteresis Effect by Micro Textile-Reinforced Compliant Mechanisms with Piezo-electric Actuators, 3rd Conference on Microactuators and Micromechanisms (MAMM), Book Series: Mechanisms and Machine Science, Volume: 30, Pages: 177-189, Timisoara, ROMANIA, ISBN:978-3-319-15862-4; 978-3-319-15861-7, ISSN: 2211-0984, Published 2015;
72. Marinca, V., Ene, R.D., Ghita, E.I., On the open problem: an optimal analytical solution for Duffing oscillator, Book Series: Applied Mechanics and Materials, Vol. 801, pp. 43--47, Published 2015;
73. Mezei, J.Z., Niyonzima, S., Backodissa, D., Pop, N., Waffeutamo, F.O., Chakrabarti, K., Motapon, O., Wolf, A., Robert, J., Dulieu, O., Larson, A., Orel, A.E., Bultel, A., Schneider, I.F. Electronic and photonic reactive collisions in edge fusion plasma and interstellar space: Application to H-2 and BeH systems, Journal of Physics Conference Series, Volume: 576, Conference on Light Element Atom, Molecule and Radical Behaviour in the Divertor and Edge Plasma Regions, Vienna, AUSTRIA, Published 2015;
74. Micu, L.M., Bordeasu, I., Popoviciu, M.O., Popescu, M., Bordeasu, D., Salcianu, L.C. Influence of volumic heat treatments upon cavitation erosion resistance of duplex X2CrNiMoN 2253 stainless steels, INTERNATIONAL CONFERENCE ON APPLIED SCIENCES 2014 (ICAS2014), IOP Conference Series Materials Science and Engineering, Volume: 85, Article Number: 012019, International Conference on Applied Sciences (ICAS), Engn Fac Hunedoara, Hunedoara, Romania, ISSN: 17578981, Published 2015;
75. Mihaescu, V. MOOC Openness - Are MOOCs as Open as They Should Be?, International Conference on Social Media in Academia - Research and Teaching (SMART), Pages: 395-400, Timisoara, ROMANIA, ISBN:978-88-7587-712-5, Published: 2015;
76. Mihut, G., Popa, E. Simulation of the bimetal cast in the case of milling rolls, INTERNATIONAL CONFERENCE ON APPLIED SCIENCES 2014 (ICAS2014), IOP Conference Series Materials Science and Engineering, Volume: 85, Article Number: 012020, International Conference on Applied Sciences (ICAS), Engn Fac Hunedoara, Hunedoara, Romania, ISSN: 17578981, Published 2015;
77. Mioc, M.A., Stratulat, M. Software Simulation of a Random Navigation Through Web Graph, International Conference on Social Media in Academia - Research and Teaching (SMART), Pages: 251-254, Timisoara, ROMANIA, ISBN:978-88-7587-712-5, Published: 2015;
78. Mocan, M., Rus, S., Draghici, A., Ivascu, L., Turi, A. Impact of Corporate Social Responsibility Practices on The Banking Industry in Romania, 2ND GLOBAL CONFERENCE ON BUSINESS, ECONOMICS, MANAGEMENT AND TOURISM, Procedia Economics and Finance, Volume: 23, Pages: 712-716, 2nd Global Conference on Business, Economics and Management and Tourism (BEMTUR), Prague, Czech Republic, ISSN: 22125671, Published 2015;
79. Mocan, M., Rus, S., Draghici, A., Ivascu, L., Turi, A. Impact of Corporate Social Responsibility Practices on The Banking Industry in Romania, 2ND GLOBAL CONFERENCE ON BUSINESS, ECONOMICS, MANAGEMENT AND TOURISM, Book Series: Procedia Economics and Finance, Volume: 23 Pages: 712-716, Location: Prague, CZECH REPUBLIC, ISSN: 2212-5671, Published: 2015;

80. Moscovici, A.M., Brebu, F.M., Gridan, M.R., David, V. Mathematical Cartography based on Georeferencing Maps, PROCEEDINGS OF THE INTERNATIONAL CONFERENCE OF NUMERICAL ANALYSIS AND APPLIED MATHEMATICS 2014 (ICNAAM2014), AIP Conference Proceedings, Volume: 1648, Article Number: UNSP 670007, International Conference on Numerical Analysis and Applied Mathematics (ICNAAM), Rhodes, Greece, ISSN: 0094243X, ISBN: 9780735412873, Published 2015;
81. Motapon, O., Niyonzima, S.; Chakrabarti, K; Mezei, J.Z., Backodissa, D., Ilie, S., Epee, M.D.E., Peres, B., Lanza, M., Tchakoua, Pop, N., Argoubi, F., Telmini, M., Dulieu, O., Bultel, A., Robert, J., Larson, A., Orel, A.E., Schneider, I.F. Advances in the MQDT approach of electron/molecular cation reactive collisions: High precision extensive calculations for applications, 9th International Conference on Dissociative Recombination: Theory, Experiment, and Applications, Paris, France, EPJ Web of Conferences, Volume: 84, Published 2015;
82. Musuroi, S., Sorandaru, C., Erdodi, G.M., Petrescu, D.I. Wind System with Storage in Electrical Accumulators, 9th International Symposium on Advanced Topics in Electrical Engineering (ATEE), Pages: 797-802, Bucharest, ROMANIA, MAY 07-09, 2015, ISBN:978-1-4799-7514-3, Published 2015;
83. Nafornta, C.; David C., Isar, A.; Preliminary Results on Sky Segmentation, Signals, Circuits and Systems (ISSCS), 2015 International Symposium on, Iasi, Romania, July 9 - 10, 2015, pp.18-21, Published 2015;
84. Negru, I., Gillich, G.R., Praisach, Z.I., Tufoi, M., Gillich, E.V., Nondestructive evaluation of piers, HEALTH MONITORING OF STRUCTURAL AND BIOLOGICAL SYSTEMS 2015, Proceedings of SPIE, Volume: 9438, Article Number: 943817, Health Monitoring of Structural and Biological Systems Conference, 9-12 May 2015, San Diego, CA, ISSN: 0277786X, ISBN: 9781628415414, Published 2015;
85. Nelson, D.B., Nafornta, C., Isar, A. Generalised M-lasso for Robust, Spatially Regularised Hurst Estimation, IEEE Global Conference on Signal and Information Processing (GlobalSIP), Orlando, Florida, USA, Published 2015;
86. Onita, M., Ciuclea, C., Vasii, R. The Value of Video Lectures in the Classroom - UPT Study Case, 21st International Conference on Information and Software Technologies (ICIST), Book Series: Communications in Computer and Information Science, Volume: 538, Pages: 127-137, Druskininkai, LITHUANIA, OCT 15-16, 2015, ISBN:978-3-319-24770-0; 978-3-319-24769-4, ISSN: 1865-0929, Published 2015;
87. Ostreika, A., Vasii, R., Gudoniene, D., Maskeliunas, R., Rutkauskiene, D. An Ontology Oriented Approach for E-Learning Objects Design and Improvement, 21st International Conference on Information and Software Technologies (ICIST), Book Series: Communications in Computer and Information Science, Volume: 538, Pages: 138-150, Druskininkai, LITHUANIA, OCT 15-16, 2015, ISBN:978-3-319-24770-0; 978-3-319-24769-4, ISSN: 1865-0929, Published 2015;
88. Pacurar, A.T., Pacurar, C., Toader, D. Photovoltaic Modules Performance Comparative Study, NANOCON 2014, 6TH INTERNATIONAL CONFERENCE, Pages: 395-399, 6th NANOCON International Conference, Brno, Czech Republic, ISBN: 9788087294536, Published 2015;
89. Pacurar, C., Pacurar, A.T., Toader, D. Energy Efficiency and Thermal Comfort In Building Integrated Photovoltaic Case Study, Source: NANOCON 2014, 6TH INTERNATIONAL CONFERENCE, Pages: 400-404, 6th NANOCON International Conference, Brno, Czech Republic, ISBN: 9788087294536, Published 2015;
90. Panoiu, C., Rob, R., Panoiu, M. Microcontroller interrupts in frequency controlling, INTERNATIONAL CONFERENCE ON APPLIED SCIENCES 2014 (ICAS2014), IOP Conference Series Materials Science and Engineering, Volume: 85, Article Number: 012022, International Conference on Applied Sciences (ICAS), Engn Fac Hunedoara, Hunedoara, Romania, ISSN: 17578981, Published 2015;
91. Panoiu, M., Rat, C.L., Panoiu, C. Video streaming technologies using ActiveX and LabVIEW Source: INTERNATIONAL CONFERENCE ON APPLIED SCIENCES 2014 (ICAS2014), IOP Conference Series Materials Science and Engineering, Volume: 85, Article Number: 012023, International Conference on Applied Sciences (ICAS), Engn Fac Hunedoara, Hunedoara, Romania, ISSN: 17578981, Published 2015;
92. Pascu, L., Socalici, A., Popa, E., Crisan, E. The Influence of Chemical Composition upon the Hardness of Brake Shoes Meant for Rolling Stock, PROCEEDINGS OF THE INTERNATIONAL CONFERENCE OF NUMERICAL ANALYSIS AND APPLIED MATHEMATICS 2014 (ICNAAM2014), AIP Conference Proceedings, Volume: 1648, Article Number: UNSP 680005, International Conference on Numerical Analysis and Applied Mathematics (ICNAAM), Rhodes, Greece, ISSN: 0094243X, ISBN: 9780735412873, Published 2015;

93. Pater, F. On Some Interpolation Properties in Locally Convex Spaces, PROCEEDINGS OF THE INTERNATIONAL CONFERENCE OF NUMERICAL ANALYSIS AND APPLIED MATHEMATICS 2014 (ICNAAM2014), AIP Conference Proceedings, Volume: 1648, Article Number: UNSP 670008, International Conference on Numerical Analysis and Applied Mathematics (ICNAAM), Rhodes, Greece, ISSN: 0094243X, ISBN: 9780735412873, Published 2015;
94. Pater, L., Cociu, N. Adjustment of Time Series using the Modified Exponential for Turnover Forecast, PROCEEDINGS OF THE INTERNATIONAL CONFERENCE OF NUMERICAL ANALYSIS AND APPLIED MATHEMATICS 2014 (ICNAAM2014), AIP Conference Proceedings, Volume: 1648, Article Number: UNSP 670005, International Conference on Numerical Analysis and Applied Mathematics (ICNAAM), Rhodes, Greece, ISSN: 0094243X, ISBN: 9780735412873, Published 2015;
95. Pater, L., Cociu, N. The Evolution of the Market Share of Competing Brands Modeled with Markov Chains, PROCEEDINGS OF THE INTERNATIONAL CONFERENCE OF NUMERICAL ANALYSIS AND APPLIED MATHEMATICS 2014 (ICNAAM2014), AIP Conference Proceedings, Volume: 1648, Article Number: UNSP 670006, International Conference on Numerical Analysis and Applied Mathematics (ICNAAM), Rhodes, Greece, ISSN: 0094243X, ISBN: 9780735412873, Published 2015
96. Perifanou, M., Holotescu, C., Andone, D., Grosseck, G. Exploring OERs and MOOCs for Learning of EU Languages, International Conference on Social Media in Academia - Research and Teaching (SMART), Pages: 389-394, Timisoara, ROMANIA, ISBN:978-88-7587-712-5, Published: 2015;
97. Popa, I., Fagadar-Cosma, E., Taranu, B.O., Birdeanu, M., Fagadar-Cosma, G., Taranu, I. Corrosion Protection Efficiency of Bilayer Porphyrin Polyaniline Film Deposited on Carbon Steel, MACROMOLECULAR SYMPOSIA, Volume: 352, Issue: 1, Special Issue: SI, Pages: 16-24, 15th International Conference on Polymers and Organic Chemistry (POC), Timisoara, Romania, ISSN: 10221360, eISSN: 15213900, Published 2015;
98. Popa, I., Popa, G.N., Deaconu, S.I., Iagar, A. Spotting the earth connection and short circuits between the electric conductors, using DC bridges for resistance measurements, INTERNATIONAL CONFERENCE ON APPLIED SCIENCES 2014 (ICAS2014), IOP Conference Series Materials Science and Engineering, Volume: 85, Article Number: 012027, International Conference on Applied Sciences (ICAS), Engh Fac Hunedoara, Hunedoara, Romania, ISSN: 17578981, Published 2015;
99. Popescu, A.D., Suci, S., Borca, C., Nodea, A., Ayotte, L. Cultural diversity evaluation in educational learning groups, 8TH INTERNATIONAL CONFERENCE INTERDISCIPLINARITY IN ENGINEERING, INTERENG 2014, Procedia Technology, Volume: 19, Pages: 1156-1163, 8th International Conference on Interdisciplinarity in Engineering (InterEng), Tirgu Mures, Romania, ISSN: 22120173, Published 2015;
100. Potra, S., Branea, A.M., Izvercian, M. How to Foster Prosumption for Value CoCreation? The Open Government Development Plan, PROCEEDINGS OF THE 15TH EUROPEAN CONFERENCE ON EGOVERNMENT, Pages: 239-245, 15th European Conference on eGovernment (ECEG), JUN 18-19, 2015, Univ Portsmouth, Portsmouth, England, ISBN: 9781910810200, Published 2015;
101. Ratiu, S., Birtok-Baneasa, C., Alexa, V., Kiss, I. Functional performance testing of the universal super absorbing air filters FSU 70 "Air by Corneliu", INTERNATIONAL CONFERENCE ON APPLIED SCIENCES 2014 (ICAS2014), IOP Conference Series Materials Science and Engineering, Volume: 85, Article Number: 012028, International Conference on Applied Sciences (ICAS), Engh Fac Hunedoara, Hunedoara, Romania, ISSN: 17578981, Published 2015;
102. Rob, R., Panoiu, C., Panoiu, M. Study regarding the power quality improvement in functioning of nonlinear loads, INTERNATIONAL CONFERENCE ON APPLIED SCIENCES 2014 (ICAS2014), IOP Conference Series Materials Science and Engineering, Volume: 85, Article Number: 012029, International Conference on Applied Sciences (ICAS), Engh Fac Hunedoara, Hunedoara, Romania, ISSN: 17578981, Published 2015;
103. Rus, S., Mocan, M., Draghici, A., Ivascu, L., Turi, A. Analysis of Cloud Computing In the Romanian Banking System for the Strategy Development Following the Economic and Financial Crisis, 25th International-Business-Information-Management-Association Conference, INNOVATION VISION 2020: FROM REGIONAL DEVELOPMENT SUSTAINABILITY TO GLOBAL ECONOMIC GROWTH, VOL I-VI, Pages: 734-743, Amsterdam, NETHERLANDS, Date: MAY 07-08, 2015, Published: 2015;
104. Rusu, G., Herban, I.S., Bala, A.C., Grecea, C. Mathematical Support for Threedimensional Transformation Points from Geocentric Reference System in Local Reference System, PROCEEDINGS OF THE INTERNATIONAL CONFERENCE OF NUMERICAL ANALYSIS AND APPLIED MATHEMATICS 2014 (ICNAAM2014), AIP Conference Proceedings, Volume: 1648, Article Number: UNSP 670011, International Conference on Numerical Analysis and Applied Mathematics (ICNAAM), Rhodes, Greece, ISSN: 0094243X, ISBN: 9780735412873, Published 2015;

105. Rusu, G., Nitu, S., Rusnac, L., Bandur, G. Polymerization Kinetic Analysis of some Glycerol and Glucose Based Polymers, MACROMOLECULAR SYMPOSIA, Volume: 352, Issue: 1, Special Issue: SI, Pages: 51-58, 15th International Conference on Polymers and Organic Chemistry (POC), Timisoara, Romania, ISSN: 10221360, eISSN: 15213900, Published 2015;
106. Sarbu, I. Influence of heating systems on indoor environment in buildings, Ecology, Economics, Education and Legislation Proc. of the 13th Intl. Multidisciplinary Scientific GeoConference SGEM2013, Albena, Bulgaria, pages 583-590, Published 2015;
107. Sarbu, I., Filip I.A. Efficient plant and procedure for sewage treatment, Proc. of the Int. Conference on Water Resource and Environmental Protection (WREP 2014), Hong Kong, China, pages 163-167, Published 2015;
108. Silasi, C., Cuntan, C., Baci, I. Using microcontrollers for orienting a set of mirrors to focus the light beam, INTERNATIONAL CONFERENCE ON APPLIED SCIENCES 2014 (ICAS2014), IOP Conference Series Materials Science and Engineering, Volume: 85, Article Number: 012009, International Conference on Applied Sciences (ICAS), Engn Fac Hunedoara, Hunedoara, Romania, ISSN: 17578981, Published 2015;
109. Simo, A., Kilyeni, St., Barbulescu, C. Artificial Intelligence based Dynamic Transmission Network Expansion Planning, 8TH INTERNATIONAL CONFERENCE ON HUMAN SYSTEM INTERACTIONS (HSI), Conference on Human System Interaction, Pages: 54-60, Title: 8th International Conference on Human System Interactions (HSI), 25-27 June 2015, Warsaw, Poland, ISSN: 21582246, ISBN: 9781467369367, Published 2015;
110. Sinescu, C., Negrutiu, M.L., Manole, M., de Sabata, A., Rusu, L.C., Stratul, St., Dudea, D., Dughir, C., Duma, V.F. Retractions of the Gingival Margins Evaluated by Holographic Methods, HOLOGRAPHY: ADVANCES AND MODERN TRENDS IV, Proceedings of SPIE, Volume: 9508, Article Number: 95080V, Conference on Holography Advances and Modern Trends IV, 15-16 April 2015, Prague, Czech Republic, ISSN: 0277786X, ISBN: 9781628416299, Published 2015;
111. Sinescu, C., Negrutiu, M.L., Nica, L., Manescu, A., Duma, V.F., Podoleanu, A.G. MicroCT and Optical Coherence Tomography imagistic assessment of the dental roots adhesive, MEDICAL IMAGING 2015: BIOMEDICAL APPLICATIONS IN MOLECULAR, STRUCTURAL, AND FUNCTIONAL IMAGING, Proceedings of SPIE, Volume: 9417, Article Number: 94170U, Conference on Medical Imaging Biomedical Applications in Molecular, Structural, and Functional Imaging, 24-26 February 2015, Orlando, FL, ISSN: 0277786X, ISBN: 9781628415070, Published 2015;
112. Sirbu, R.M. European Union strategy and foreign direct investments impact on Romania's regional development, CHALLENGES AND INNOVATIONS IN MANAGEMENT AND LEADERSHIP 12TH INTERNATIONAL SYMPOSIUM IN MANAGEMENT, Procedia Social and Behavioral Sciences, Volume: 124, Pages: 442-450, 12th International Symposium in Management (SIM), Timisoara, Romania, Published 2015;
113. Sirbu, R.M., Popescu, A.D., Borca, C., Draghici, A. A study on Romania sustainable development, 8TH INTERNATIONAL CONFERENCE INTERDISCIPLINARITY IN ENGINEERING, INTERENG 2014, Procedia Technology, Volume: 19, Pages: 416-423, 8th International Conference on Interdisciplinarity in Engineering (InterEng), Tirgu Mures, Romania, ISSN: 22120173, Published 2015;
114. Sirbu, R.M., Borca, C., Draghici, A., Lobont, OR. The implication of Corporate Social Responsibility on the sustainable development in Romania, 4th Review of Management and Economic Engineering International Management Conference, Book Series: Review of Management and Economic Engineering International Management Conference, Pages: 106-114, Cluj Napoca, ROMANIA, Published 2015;
115. Socalici, A., Pascu, L., Popa, E., Heput, T. The influence of the cast iron structure upon the hardness of brake shoes meant for the rolling sock, INTERNATIONAL CONFERENCE ON APPLIED SCIENCES 2014 (ICAS2014), Book Series Title: IOP Conference Series Materials Science and Engineering, Volume: 85, Article Number: 012026, International Conference on Applied Sciences (ICAS), Engn Fac Hunedoara, Hunedoara, Romania, ISSN: 17578981, Published 2015;
116. Suciu, L., Lateral Strategies in Communication, Debates on Globalisation. Approaching National Identity through Intercultural Dialogue, Proceedings of the 2-nd International Conference Globalisation, Intercultural Dialogue and National Identity, Edition, 28-29 May 2015, Targu-Mures, vol.2, pp.165-169. ISBN 987-606-93692-5-8, Published 2015;
117. Suciu, L., Şimon, S., Cultural awareness interpreting, 7th World Conference on Educational Sciences, 5-8.02.2015, Greece, Procedia – Social and Behavioral Sciences Athens, vol. 197, pp. 1242-1245, ISSN 1877-0428, Published 2015;

118. Suciu, L., Şimon, S., Informing strategies: building the communication framework, 7th World Conference on Educational Sciences, 5-8.02.2015, Greece, Procedia – Social and Behavioral Sciences Athens, vol. 197, pp.1246-1249, ISSN 1877-0428, Published 2015;
119. Suciu, L., Şimon, S., Kilyeni, A. Developing the PR Students'Written Communication Skills, 6th World Conference on Educational Sciences, Procedia – Social and Behavioral Sciences, vol. 191, Valetta, Malta, pp. 709-712, ISSN 1877-0428, Published 2015;
120. Suciu, L., Şimon, S., Kilyeni, A. Strategies for Improving the English Pronunciation of the 1st Year "Translation-Interpreting", 6th World Conference on Educational Sciences, 6-9.02.2014, Procedia – Social and Behavioral Sciences, vol. 191, Valetta, Malta, pp. 2157-2160, ISSN 1877-0428, Published 2015;
121. Suciu, L., Şimon, S., Kilyeni, A. Terminology Management: Applications in Teaching ESP to Public Relations Students 6th World Conference on Educational Sciences, 6-9.02.2014, Procedia – Social and Behavioral Sciences, vol. 191, Valetta, Malta, pp.2254-2260, ISSN 1877-0428, Published 2015;
122. Tănase, D. Specific Criteria in Selecting Input Materials for Teaching the Language of Product Description, Proceedings of 2nd Global Conference on Conference on Linguistics and Foreign Language Teaching, LINELT, Dubai, United Arab Emirates, vol. 192, pp.543-546, 2015;
123. Topirceanu, A., Tiselice, D., Udrescu, M. The Fingerprint of Educational Platforms in Social Media: A Topological Study Using Online Ego-Networks, International Conference on Social Media in Academia - Research and Teaching (SMART), Pages: 355-360, Timisoara, ROMANIA, ISBN:978-88-7587-712-5, Published: 2015;
124. Topirceanu, A., Udrescu, M. Gamified: An Effective Approach to Student Motivation Using Gamification, International Conference on Social Media in Academia - Research and Teaching (SMART), Pages: 41-44, Timisoara, ROMANIA, ISBN:978-88-7587-712-5, Published: 2015;
125. Totorean, A.F., Bernad, S.I., Susan-Resiga, R.F. A Helical Pipe Investigation from a Cardiovascular Perspective, PROCEEDINGS OF THE INTERNATIONAL CONFERENCE OF NUMERICAL ANALYSIS AND APPLIED MATHEMATICS 2014 (ICNAAM2014), AIP Conference Proceedings, Volume: 1648, Article Number: 030033, International Conference on Numerical Analysis and Applied Mathematics (ICNAAM), Rhodes, Greece, ISSN: 0094243X, ISBN: 9780735412873, Published 2015;
126. Trusculescu, A., Draghici, A. and Albulescu C.T. Key Metrics and Key Drivers in the Valuation of Public Enterprise Resource Planning Companies, Procedia Computer Science, Volume 64, pages 917-923, 2015;
127. Tutelea, L.N., Deaconu, S.I., Popa, G.N. Dual stator winding variable speed asynchronous generator: optimal design and experiments, INTERNATIONAL CONFERENCE ON APPLIED SCIENCES 2014 (ICAS2014), IOP Conference Series Materials Science and Engineering, Volume: 85, Article Number: 012010, International Conference on Applied Sciences (ICAS), Engn Fac Hunedoara, Hunedoara, Romania, ISSN: 17578981, Published 2015;
128. Ursu, D., Miclau, M., Banica, R., Bucur, R., Vaszilcsin, N., Chiosa, M. Effect of the Mg substitution on the structural, optical and electrical properties of CUCRO2 for applications to p-type dye-sensitized solar cells, NANOCON 2014, 6TH INTERNATIONAL CONFERENCE, Pages: 390-394, 6th NANOCON International Conference, Brno, Czech Republic, ISBN: 9788087294536, Published 2015;
129. Vatasescu, M., Risk Assessment of Demolition Activity with the Help of Explosives, PROCEEDINGS OF THE INTERNATIONAL CONFERENCE OF NUMERICAL ANALYSIS AND APPLIED MATHEMATICS 2014 (ICNAAM2014), AIP Conference Proceedings, Volume: 1648, International Conference on Numerical Analysis and Applied Mathematics (ICNAAM), Rhodes, Greece, ISSN: 0094243X, ISBN: 9780735412873, Published 2015;
130. Vatasescu, M., Software for the Occupational Health and Safety Integrated Management System, PROCEEDINGS OF THE INTERNATIONAL CONFERENCE OF NUMERICAL ANALYSIS AND APPLIED MATHEMATICS 2014 (ICNAAM2014), AIP Conference Proceedings, Volume: 1648, Article Number: UNSP 680007, International Conference on Numerical Analysis and Applied Mathematics (ICNAAM), Rhodes, Greece, ISSN: 0094243X, ISBN: 9780735412873, Published 2015;

131. Vatasescu, M., Vatasescu, M., Vasilescu, G.D., Lemle, L.D. Advanced Research in the Field of Instruments for Use in the Probabilistic Study of Security, PROCEEDINGS OF THE INTERNATIONAL CONFERENCE OF NUMERICAL ANALYSIS AND APPLIED MATHEMATICS 2014 (ICNAAM2014), AIP Conference Proceedings, Volume: 1648, Article Number: UNSP 680008, International Conference on Numerical Analysis and Applied Mathematics (ICNAAM), Rhodes, Greece, ISSN: 0094243X, ISBN: 9780735412873, Published 2015;
132. Vatasescu, M., Vatasescu, M., Vasilescu, G.D., Lemle, L.D., Evaluating the Safety Risk in Relation to the Energetic Field, PROCEEDINGS OF THE INTERNATIONAL CONFERENCE OF NUMERICAL ANALYSIS AND APPLIED MATHEMATICS 2014 (ICNAAM2014), AIP Conference Proceedings, Volume: 1648, Article Number: UNSP 680006, International Conference on Numerical Analysis and Applied Mathematics (ICNAAM), Rhodes, Greece, ISSN: 0094243X, ISBN: 9780735412873, Published 2015;
133. Vert, S. Linked Open Government Data for Smart City Applications, International Conference on Social Media in Academia - Research and Teaching (SMART), Pages: 401-406, Timisoara, ROMANIA, ISBN:978-88-7587-712-5, Published: 2015;
134. Vlasin, I., Chirila, CB., The model of a competence based e-learning platform for primary and middle school students, International Conference on Social Media in Academia - Research and Teaching (SMART), Pages:179-184, Timisoara, ROMANIA, ISBN:978-88-7587-712-5, Published: 2015;

BOOKS

EVOLUTION OF BOOKS UNDER AFFILIATIONS OF UPT 2013-2015

A published book is indisputable evidence of research that has been performed, completed, and accepted by peers. Book is also an indicator of achievement of a certain academic standard. Besides communication of a finalised piece of research, the book is the basis for further opinions, views and critiques from fellow professionals and academics separated by time and distance. Most importantly, it represents the only permanent record of scientific work that has been completed.

In this chapter we present the books written by our professors and researchers, published at Romanian publishers and as well as at international prestigious publishers.

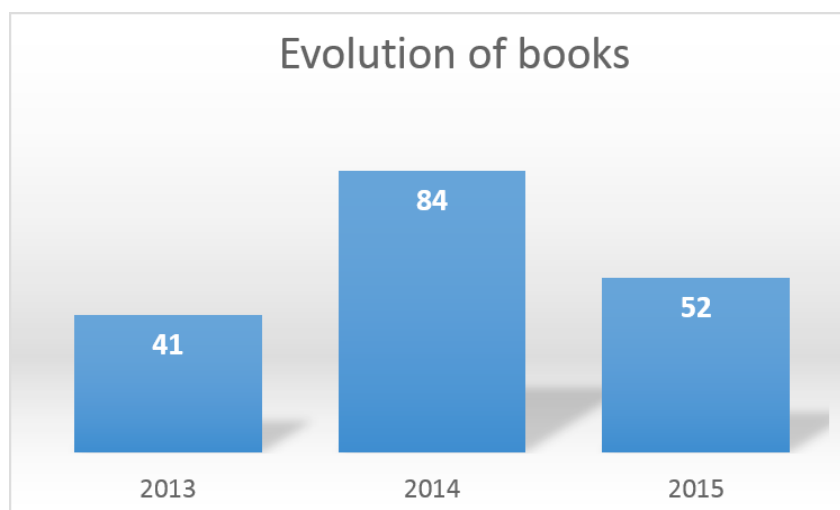

Books in highlight

THE OPTIMAL HOMOTOPY ASYMPTOTIC METHOD. ENGINEERING APPLICATIONS

Vasile MARINCA, Nicolae HERISANU

SPRINGER International Publishing AG Switzerland, 2015, 465 p.
ISBN 978-3-319-15373-5, DOI 10.1007/978-3-319-15374-2

Short description of the context

This book published in 2015 by the famous Springer International Publishing AG Switzerland, which is part of Springer Science+Business Media (www.springer.com), is a detailed continuation of another book written by the same authors and published by Springer in 2011: "Nonlinear Dynamical Systems in Engineering: Some Approximate Approaches", ISBN 978-3-642-22735-6.

Purpose and Motivation of the book

The main goal of the book is to emphasize the applicability of the Optimal Homotopy Asymptotic Method (OHAM) to various engineering applications. It contains a great amount of models related to the fields of vibration, classical and fluid mechanics, thermodynamics, electrical machines, physics, and so on.

Summary

The book is organized on 5 chapters.

- Chapter 1 is an introduction and the second chapter presents a short history of the development of homotopy methods, including the basic idea of the Optimal Homotopy Asymptotic Method (OHAM) proposed for the first time in the literature by the authors of this book in 2008.
- It is to remark that many researchers adopted this method within their investigations and more PhD thesis were already defended based on application of the method proposed by the authors of this book.
- The following three chapters, from Chapter 3 to Chapter 5 introduce three distinct alternatives of the Optimal Homotopy Asymptotic Method solving illustrative applications to various nonlinear dynamical systems.
- The first alternative of OHAM involving two iterations is introduced in Chapter 3, where are detailed developed five applications from the fields of nonlinear oscillations and fluid mechanics.

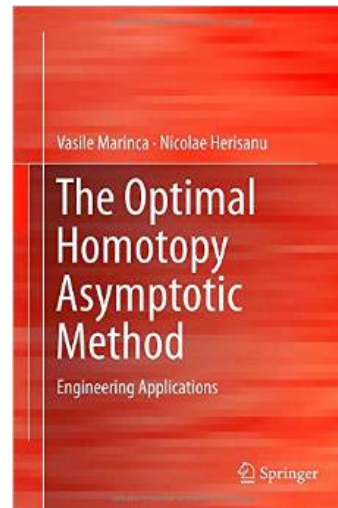

- The Chapter 4 is devoted to the Optimal Homotopy Asymptotic Method with a single iteration and solving the linear equation on the first approximation. This is the most extended chapter, since here are treated 32 models from the fields of nonlinear damped and undamped oscillations, fluid mechanics, thermodynamics, electrical machines, and even from physics and biology.
- Finally, Chapter 5 deals with the Optimal Homotopy Asymptotic Method with a single iteration, but without solving the equation in the first approximation.
- The whole book contains 41 case studies from various engineering branches and is based solely on the research activity and research results of the two authors. There are included 256 figures, 177 tables and more than 350 references.
- It is to remark that the book is already present in the libraries of the most important top universities of the world and is mainly intended for researchers, university staff, PhD students and also for MSc students.

GROUND-SOURCE HEAT PUMPS: FUNDAMENTALS, EXPERIMENTS AND APPLICATIONS

Ioan SARBU, Calin SEBARCHIEVICI

ELSEVIER, 2015, 216 p.

ISBN 978-0-12-804220-5, DOI: 10.1016/B978-0-12-804220-5.00001-1

Short description of the context

This book published in 2015 by the famous Elsevier Ltd. treats a modern issue of great current interest at a high scientific and technical level, based both on original research and achievements and on the synthesis of consistent bibliographic material to meet the increasing need for modernisation and for greater energy efficiency of building services to significantly reduce CO₂ emissions.

Purpose and Motivation of the book

The book mainly presents a detailed theoretical study and experimental investigations on ground source heat pump technology, concentrating on ground-coupled heat pump systems. It also offers a comprehensive and consistent overview of geothermal heat pump applications, performance and combination with heating/cooling systems and covers the technical, economic and energy savings aspects related to the design, modelling and operation of these systems. Additionally, the book presents information concerning the characteristics of working refrigerants in mechanical compression heat pumps and specific equipments.

Summary

The book is structured into seven chapters.

- Chapter 1 summarises a description of renewable energy, concentrating on geothermal energy, and presents the operation principle of a heat pump (HP) and the necessity for using HPs in the heating/cooling systems of buildings.
- Chapter 2 discusses the vapour compression-based heat pump (VCBHP) systems and describes the theoretical and real thermodynamic cycles and their calculation, as well as the operation regimes of a VCBHP with electro-compressor.
- Chapter 3 presents a study on the recent development of possible substitutes for non-ecological refrigerants for heating, ventilating, air conditioning and refrigeration equipment based on thermodynamic, physical and environmental properties and total equivalent warming impact analysis. The studies reported with new refrigerants in heat pumps, domestic and commercial refrigerators, chillers and air-conditioners are also explored.
- Chapter 4 presents a detailed description of the refrigeration compressor types (reciprocating, rotary screw, centrifugal and scroll compressors) and the HP types. Important information on the selection of the heat source and HP systems and domestic hot water (DHW) production for nearly zero-energy buildings are discussed.

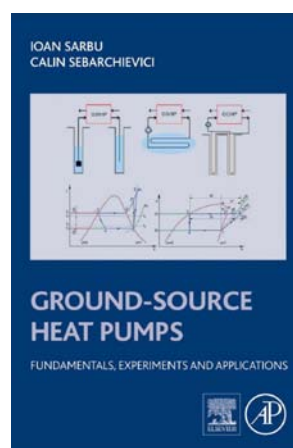

- Chapter 5 presents a detailed description of ground characteristics, ground-source heat pumps (GSHPs), and GSHP development. It also discusses the most common simulation models and programs of the vertical ground heat exchangers or borehole heat exchangers currently available, and describes different applications of the models and programs.
- Chapter 6 performs an energy-economic analysis and compares different heating systems in terms of energy consumption, thermal comfort and environmental impact. The energy, economic and environmental performances of a closed-loop ground-coupled heat pump (GCHP) system is analysed and the main performance parameters (energy efficiency and CO₂ emissions) of radiators and radiant floor heating systems connected to GCHPs are also compared. Additionally, two numerical simulation models of useful thermal energy and the system coefficient of performance in heating mode are developed using the Transient Systems Simulation (TRNSYS) software.
- Chapter 7 focuses on the energy and environmental analysis and modelling of a reversible GCHP. One of the main innovative contributions of this study is in the achievement and implementation of an energy-operational optimisation device for the GCHP system using quantitative adjustment with a buffer tank and a variable speed circulating pump. Experimental measurements are used to test the performance of the GCHP system at different operating modes. Finally, two simulation models of thermal energy consumption in heating/cooling and DHW operation were developed using TRNSYS software.

It is remark that the book is already present in the libraries of the most important top universities of the world and is mainly intended for researchers, academics, graduate students, MSc students and PhD students, and also for industrialists or consultants in this area.

1. Albu, A., Stanciu, L. Programarea calculatoarelor. Limbajul C, Editura Politehnica, Timișoara, 2015, ISBN/ISSN 978-606-554-999-9;
2. Argeșeanu, A. Algoritmi de optimizare în inginerie electrică. Probleme practice, Editura Politehnica, Timișoara, 2015, ISBN/ISSN 978-606-554-976-0;
3. Ardelean, M., Socalici, A., Ardelean, E. Tehnologia materialelor, Editura Politehnica, Timișoara, 2015, ISBN/ISSN 978-606-554-879-1;
4. Băbăiță, M.I. Circuite integrate digitale. Culegere de problem, Editura Politehnica, Timișoara, 2015, ISBN/ISSN 978-606-35-0007-7;
5. Belea, Ghe, Voicu, C. Elemente de geometrie descriptive, Editura Politehnica, Timișoara, 2015, ISBN/ISSN 978-606-554-993-7;
6. Birișcu, M., Madescu, Ghe. Modele de câmp și modele de circuit în analiza mașinilor electrice, Editura Politehnica, Timișoara, 2015, ISBN/ISSN 978-606-554-896-1;
7. Boran, S., Popa, S. Fenomene de transfer, operații unitare și utilaje în ingineria chimică. Manual pentru uzul studenților, Editura Politehnica, Timișoara, 2015, ISBN/ISSN 978-606-554-910-4;
8. Botescu, M. Arhitectural environment, Editura Politehnica, Timișoara, 2015, ISBN/ISSN 978-606-554-840-4;
9. Botoca, C., Stolojescu Crișan, C. Selected topics in communication engineering, Editura Politehnica, Timișoara, 2015, ISBN/ISSN 978-606-554-971-5;
10. Brata, S., Ostafe, P. Termotehnică. Teorie și aplicații. Vol II, Editura Politehnica, Timișoara, 2015, ISBN/ISSN 978-606-554-748-3;
11. Brebu, F.M., Cartografie. Concepte, Editura Politehnica, Timișoara, 2015, ISBN/ISSN 978-606-35-0017-6;
12. Cioablă, A., Crăciun, A., Mihai, I. Necesitatea practicii relevante în pregătirea profesională a studenților, viitori specialiști pe piața muncii, Editura Politehnica, Timișoara, 2015, ISBN/ISSN 978-606-35-0015-2;
13. Cioablă, A., Crăciun, A., Mihai, I. Corelarea activității din lucrarea de Licență/Master cu stagiile de practică, Editura Politehnica, Timișoara, 2015, ISBN/ISSN 978-606-35-0016-9;
14. Cunțan, C.D., Baci, I. Circuite integrate digitale. Aplicații, Editura Politehnica, Timișoara, 2015, ISBN/ISSN 978-606-554-909-8;
15. David, I., Beilicci, E., Beilicci, R. Chapter 8: Basics for Hydraulic Modelling of Flood Runoff Using Advanced Hydroinformatic Tools, pp 205-239, DOI: 10.4018/978-1-4666-8438-6.ch008, Book title: Extreme Weather and Impacts of Climate Change on Water Resources, USA, IGI Global Research Essentials 2015. 1-481. Web. 29 Sep. DOI: 10.4018/978-1-4666-8438-6, ISBN13: 9781466684386|ISBN10: 1466684380|EISBN13: 9781466684393];
16. Dordea, T. Electrical machines. Fortran programs, Editura Politehnica, Timișoara, 2015, ISBN/ISSN 978-606-554-938-8;
17. Grigore, C. Activități de timp liber pentru tineri, Editura Politehnica, Timișoara, 2015, ISBN/ISSN 978-606-554-744-5;

18. Gridan, M.R. Topografie. Aplicații și exerciții practice, Editura Politehnica, Timișoara, 2015, ISBN/ISSN 978-606-554-907-4;
19. Korodi, A., Huple, T. Elemente de automată. Aplicații, Editura Politehnica, Timișoara, 2015, ISBN/ISSN 978-606-554-900-5;
20. Lascu, M., Ionel, R. Programare grafică, Editura Politehnica, Timișoara, 2015, ISBN/ISSN 978-606-554-908-1;
21. Lazăr, I.C. Analiză matematică, Editura Politehnica, Timișoara, 2015, ISBN/ISSN 978-606-554-995-1;
22. Marcu, M. Introducere în programarea android, Editura Politehnica, Timișoara, 2015, ISBN/ISSN 978-606-554-986-9;
23. Marinca, V., Herisanu, N. The optimal homotopy asymptotic method. Engineering applications. Springer International Publishing AG Switzerland, 2015, 465 p. ISBN 978-3-319-15373-5, DOI 10.1007/978-3-319-15374-2, 2015;
24. Mârșu, R., Mărănescu, V., Căleanu, C., Practical aspects of electronic device and circuits, editura Politehnica, Timișoara, 2015, ISBN/ISSN 978-606-554-990-6;
25. Mateaș, M. Radiocomunicații. Ghid operativ pentru formațiunile de voluntari, Editura Politehnica, Timișoara, 2015, ISBN/ISSN 978-606-35-0001-5;
26. Mateaș, M. Radiocomunicații de urgență. Manual pentru formațiunile de intervenție rapidă pe bază de voluntariat, Editura Politehnica, Timișoara, 2015, ISBN/ISSN 978-606-35-0000-8;
27. Mihai, I. Productivitatea în dimensiune spațială. Analiză teoretică și studiu , Editura Politehnica, Timișoara, 2015, ISBN/ISSN 978-606-554-913-5;
28. Miheț Popa, L. Algoritmi de modelare și simulare în inginerie electrică utilizând pachetul de programe MATLAB ȘI SIMULINK, Editura Politehnica, Timișoara, 2015, ISBN/ISSN 978-606-554-213-6;
29. Miheț Popa, L., Aancuți, C. Algoritmi de simulare în inginerie electrică. Aplicații practice, Editura Politehnica, Timișoara, 2015, ISBN/ISSN 978-606-554-829-9;
30. Nițu, S., Boran, S. Chimie organică prin teste și probleme, Editura Politehnica, Timișoara, 2015, ISBN/ISSN 978-606554-966-1;
31. Obrad, C.I., Gherhes, V. Chapter: Analyzing Socio-Demographic Data for Profiling A Community. Case Study: Ticleni Town, Gorj County, Romania, Book Title: Social Research: Theory and Practice, Editura Pro Universitaria, Bucuresti, pg. 366-381, 2015, ISBN 978-606-26-0319-9;
32. Oprea Stănescu, P.D. Autovehicule electrice, hibride și cu pile de combustie, Editura Politehnica, Timișoara, 2015, ISBN/ISSN 978-606-35-0011-4;
33. Orlescu, M., Costescu, A. Utilizarea energiilor regenerabile în îmbunătățiri funciare, Editura Politehnica, Timișoara, 2015, ISBN/ISSN 978-606-35-0008-4;
34. Pinca Bretotean, C. Echipamente mecanice industriale. Teme experimentale, Editura Politehnica, Timișoara, 2015, ISBN/ISSN 978-606-554-912-8;
35. Păunescu D., Juratoni A. Calcul integral avansat, Editura Orizonturi Universitare, Timisoara, 2015, ISBN: 978-973-638-585-8;

36. Pop, M. C. La traduction. Aspects théoriques, pratiques et didactiques (domaine français-roumain), Ediția a 2-a, Orizonturi universitare, Timișoara, Casa Cărții de Știință, Cluj Napoca, 2015, 238 pag., ISBN 978-973-638-597-1; ISBN 978-606-17-0750-8;
37. Pop, M. C. Etica și deontologia traducerii, Orizonturi universitare, Timișoara, Casa Cărții de Știință, Cluj-Napoca, 2015, 238 pag. ISBN 978-973-638-599-5; ISBN 978-606-17-0751-5;
38. Pop, M. C. Le français contemporain. Notes de cours, Orizonturi universitare, Timișoara, 2015, 201 pag. ISBN 978-973-638-588-9;
39. Pop, M. C. Communiquer en français du bâtiment, Orizonturi universitare, Timișoara, 2015, 151 pag., ISBN 978-973-638-592-6;
40. Ionel, S. Pradigma elenă. Eseuri, Editura Politehnica, Timișoara, 2015, ISBN/ISSN 978-606-554-989-0;
41. Sârbu, I., Sebarchievici, C. Ground-Source Heat Pumps: Fundamentals, experiments and applications, Elsevier, 2015, ISBN 978-0-12-804220-5;
42. Sârbu, I., Sebarchievici, C. Geothermal Energy, Chapter: Using ground-source heat pump systems for heating/cooling of buildings, InTech, 2015, ISBN 978-953-51-4608-7;
43. Sârbu, I., Pacurar, C. Chapter: Assessment of indoor environment quality and schoolwork performance in university buildings, Book title: Environmental Quality and Human Health, Nova Science Publisher, 2015, ISBN 978-1-63483-551-0;
44. Simion, G., Papazian, P. Digital Integrated circuits. Practical aspects, Editura Politehnica, Timișoara, 2015, ISBN/ISSN 978-606-554-988-3;
45. Socalici, A., Miloștean, D. Baza energetică și de materii prime în industria de material, Editura Politehnica, Timișoara, 2015, ISBN/ISSN 978-606-554-888-6;
46. Ștefănescu, M., Ștefănescu, O.E. Chimie analitică instrumentală. Principii. Aplicații. Experimente, , Editura Politehnica, Timișoara, 2015, ISBN/ISSN 978-606-35-0005-3;
47. Stoia, D.I., Vigaru, C.S., Dobrescu, L.C. Mecanică.Cinematică, Editura Politehnica, Timișoara, 2015, ISBN/ISSN 978-606-554-958-6;
48. Suciu, L. Kilyeni A. Ghid de comunicare scrisă și orală, Casa Cărții de Știință Cluj & Orizonturi Universitare Timișoara, 2015, ISBN 978-606-17-0752-2; 978-973-638-596-4;
49. Tutelea, L. Tehnici de programare în C. Aplicații pentru însușirea noțiunilor de bază, Editura Politehnica, Timișoara, 2015, ISBN/ISSN 978-606-554-864-0;
50. Tutelea, L., Deaconu, S. Dual Rotor single stator permanent magnet motors, Editura Politehnica, Timișoara, 2015, ISBN/ISSN 978-606-554-861-9;
51. Verdeș, O., Popa, A. Sinteza și proprietățile acidului fosfowolframic și sărurile sale, Editura Politehnica, Timișoara, 2015, ISBN/ISSN 978-606-554-850-3;
52. Zăbavă , E.S. Proiectare tehnică asistată de calculator, Editura Politehnica, Timișoara, 2015;



Politehnica University of Timisoara



Piata Victoriei No. 2
RO 300006, Timisoara
Tel: +40 256 40 30 00
Fax: +40 256 40 30 21
Email: rector@upt.ro
www.upt.ro



EDITURA POLITEHNICA

ISSN 1841-2769